

# AZ DISPLAYS

---

## SPECIFICATIONS FOR LIQUID CRYSTAL DISPLAY

CUSTOMER APPROVAL			
<p>※ PART NO. : <u>ATM0700D6J-CT (AZ DISPLAYS) VER1.0</u></p>			
<b>APPROVAL</b>		<b>COMPANY CHOP</b>	
<b>CUSTOMER COMMENTS</b>			

AZ DISPLAYS ENGINEERING APPROVAL		
DESIGNED BY	CHECKED BY	APPROVED BY

**REVISION RECORD**

REVISION	REVISION DATE	PAGE	CONTENTS
<b>VER1.0</b>	<b>2014-09-05</b>		<b>FIRST ISSUED</b>

※ **CONTENTS**

1. GENERAL SPECIFICATIONS
2. PIN ASSIGNMENT
3. OPERATING SPECIFICATIONS
4. OPTICAL SPECIFICATIONS
5. RELIABILITY TEST
6. PRECAUTION FOR USING LCM
7. MECHANICAL DRAWING
8. PACKAGE DRAWING
9. INSPECTION SPECIFICATION

## 1. GENERAL SPECIFICATIONS

Item	Specification	Remark
1. LCD size	7.0 inch(Diagonal)	
2. Driver element	a-Si TFT active matrix	
3. Resolution	800x(RGB)x480	
4. Display mode	Normally white , Transmissive	
5. Dot Pitch (W*H)	0.0642mm(W) x 0.1790mm(H)	
6. Pixel pitch(W*H)	0.1926mm(W) x 0.1790mm(H)	
7. Active Area(W*H)	154.08mm(W) x 85.92mm(H)	
8. Module size (W*H)	165.0mm(W) x 100.0mm(H) x 5.8mm(D)	Note 1
9. Surface treatment	Anti-glare	
10. Bezel material	Stainless steel	
11. Color arrangement	RGB-stripe	
12. View Direction	12 O'Clock	
12. Color	16.7M	
13. Interface	24bit RGB interface	
14. Weight	150g(Typ.)	
15. RoHS	RoHS compliant	

**Note 1: Please refer to mechanical drawing.**

## 2. PIN ASSIGNMENT

### TFT LCD Panel Driving Section

FPC Connector is used for the module electronics interface. The recommended model is FH12A-50S-0.5SH manufactured by Hirose.

Pin No.	Symbol	Function	Level	Note
1,2	V <sub>LED+</sub>	Power for LED backlight(Anode)	P	
3,4	V <sub>LED-</sub>	Power for LED backlight(Cathode)	P	
5	GND	Power ground	P	
6	V <sub>COM</sub>	Common voltage	P	
7	DV <sub>DD</sub>	Power for digital circuit	P	
8	MODE	DE/SYNC mode select	I	Note 1
9	DE	Data input enable	I	
10	VS	Vertical sync input	I	
11	HS	Horizontal sync input	I	
12~17	B7~B2	Blue data	I	
18~19	B1~B0	Blue data	I	Note 2
20~25	G7~G2	Green data	I	
26~27	G1~G0	Green data	I	Note 2
28~33	R7~R2	Red data	I	
34~35	R1~R0	Red data	I	Note 2
36	GND	Power ground	P	
37	DCLK	Sample clock	I	Note 3
38	GND	Power ground	P	
39	L/R	Left/Right selection	I	Note 4,5
40	U/D	Up/Down selection	I	Note 4,5
41	V <sub>GH</sub>	Gate on voltage	P	
42	V <sub>GL</sub>	Gate off voltage	P	
43	AV <sub>DD</sub>	Power for analog circuit	P	
44	RESET	Global reset pin	I	Note 6
45	NC	No connection	--	
46	V <sub>COM</sub>	Common voltage	P	
47	DITHB	Dithering function	I	Note 7
48	GND	Power ground	P	
49~50	NC	No connection	--	

**I: input, O: output, P: Power**

**Note 1:** DE/SYNC mode select. Normally pull high.

When select DE mode, MODE="1", VS and HS must pull high.

When select SYNC mode, MODE="0", DE must be grounded.

**Note 2:** When input 18 bits RGB data, the two low bits of R,G and B data must be grounded.

**Note 3:** Data shall be latched at the falling edge of DCLK.

**Note 4:** Selection of scanning mode

Setting of scan control input		Scanning direction
U/D	L/R	
GND	DV <sub>DD</sub>	Up to down, left to right
DV <sub>DD</sub>	GND	Down to up, right to left
GND	GND	Up to down, right to left
DV <sub>DD</sub>	DV <sub>DD</sub>	Down to up, left to right

**Note 5:** Definition of scanning direction.  
Refer to the figure as below:

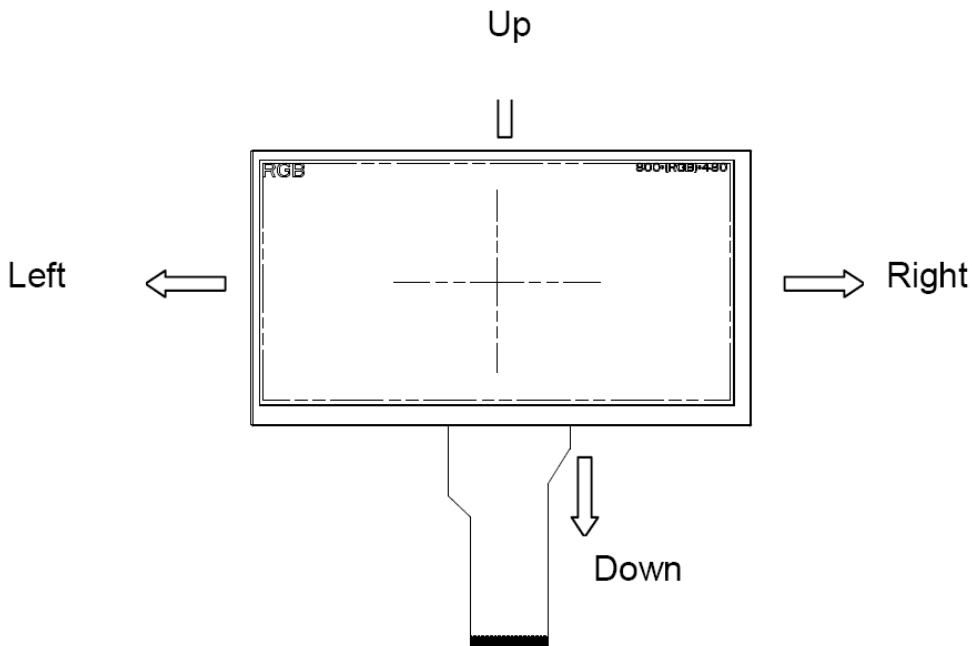

**Note 6:** Global reset pin. Active low to enter reset state. Suggest to connect with an RC reset circuit for stability. Normally pull high.

**Note 7:** Dithering function enable control, normally pull high.  
When DITHB="1", Disable internal dithering function,  
When DITHB="0", Enable internal dithering function,

# ATM0700D6J-CT(AZ DISPLAYS)TFT MODULE VER1.0

## Touch Panel Section

Recommended connector: Hirose FH12-6S-1SH(55) or compatible

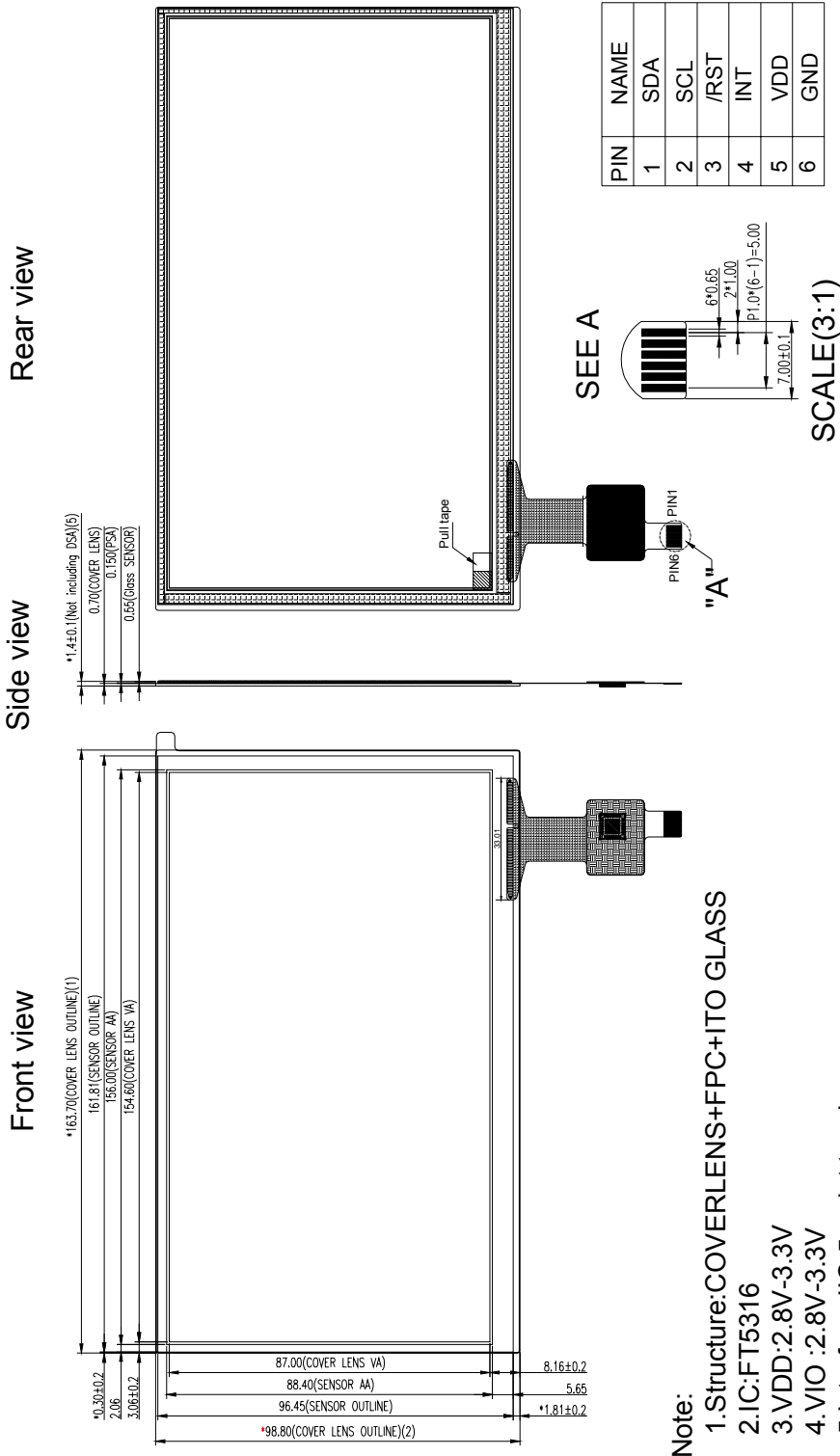

### 3. Operating Specification

#### 3.1 ABSOLUTE MAXIMUM RATINGS

Item	Symbol	Values		Unit	Remark
		Min.	Max.		
Power Voltage	$DV_{DD}$	-0.3	5.0	V	
	$AV_{DD}$	6.5	13.5	V	
	$V_{GH}$	-0.3	40	V	
	$V_{GL}$	-20	0.3	V	
	$V_{GH}-V_{GL}$	--	40	V	
Operation Temperature	$T_{OP}$	-20	70	°C	
Storage Temperature	$T_{ST}$	-30	80	°C	
LED Reverse Voltage	$V_R$	-	1.2	V	Each LED Note 2
LED Forward Current	$I_F$		25	mA	Each LED

**Note 1:** The absolute maximum rating values of this product are not allowed to be exceeded at any times. Should a module be used with any of the absolute maximum ratings exceeded, the characteristics of the module may not be recovered, or in an extreme case, the module may be permanently destroyed.

**Note 2:**  $V_R$  Conditions: Zener Diode 20mA

#### 3.1.1 Typical Operation Conditions

Item	Symbol	Values			Unit	Remark
		Min.	Typ.	Max.		
Power Voltage	$DV_{DD}$	3.0	3.3	3.6	V	Note 2
	$AV_{DD}$	6.5	10.4	10.6	V	
	$V_{GH}$	15.3	16.0	16.7	V	
	$V_{GL}$	-7.7	-7	-6.3	V	
Input Signal Voltage	$V_{COM}$	2.6	3.6	4.6	V	
Input Logic High Voltage	$V_{IH}$	$0.7DV_{DD}$	--	$DV_{DD}$	V	Note 3
Input Logic Low Voltage	$V_{IL}$	0	--	$0.3DV_{DD}$	V	Note 3

**Note 1:** Be sure to apply  $DV_{DD}$  and  $V_{GL}$  to the LCD first, and then apply  $V_{GH}$ .

**Note 2:**  $DV_{DD}$  setting should match the signals output voltage (refer to Note 3) of customer's system board.

**Note 3:** DCLK,HS,VS,RESET,U/D, L/R,DE,R0~R7,G0~G7,B0~B7,MODE,DITHB.

#### 3.1.2 Current Consumption

Item	Symbol	Values			Unit	Remark
		Min.	Typ.	Max.		
Power Voltage	$I_{GH}$	--	0.2	1.0	mA	$V_{GH}=16.0V$
	$I_{GL}$	--	0.2	1.0	mA	$V_{GL}=-7.0V$
	$I_{DVDD}$	--	4.0	10	mA	$DV_{DD}=3.3V$
	$I_{AVDD}$	--	20	50	mA	$AV_{DD}=10.4V$



### 3.1.3 Backlight driving conditions

Item	Symbol	Values			Unit	Remark
		Min.	Typ.	Max.		
Voltage for LED Backlight	$V_L$	9.0	10	11	V	Note 1
Current for LED Backlight	$I_L$	--	330	--	mA	
LED life time	--	30000	--	--	Hr	Note 2

**Note 1:** The LED Supply Voltage is defined by the number of LED at  $T_a=25^{\circ}\text{C}$  and  $I_L=330\text{mA}$ .

**Note 2:** The "LED life time" is defined as the module brightness decrease to 50% original brightness at  $T_a=25^{\circ}\text{C}$  and  $I_L=330\text{mA}$ .

### 3.2 Power Sequence

#### a. Power on:

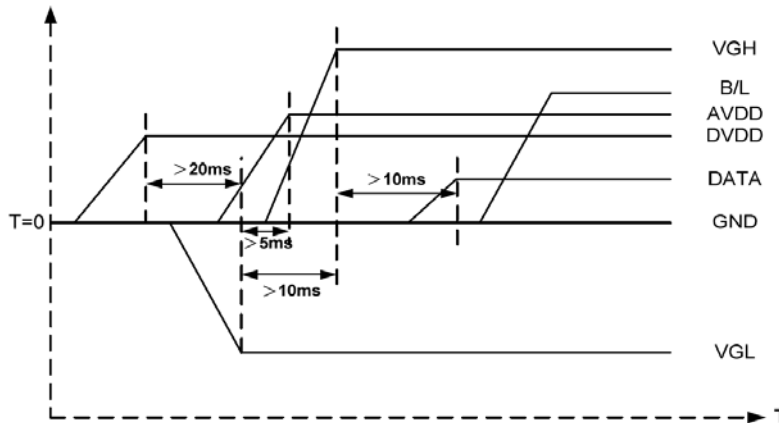

$DV_{DD} \rightarrow V_{GL} \rightarrow V_{GH} \rightarrow \text{Data} \rightarrow \text{B/L}$

#### b. Power off:

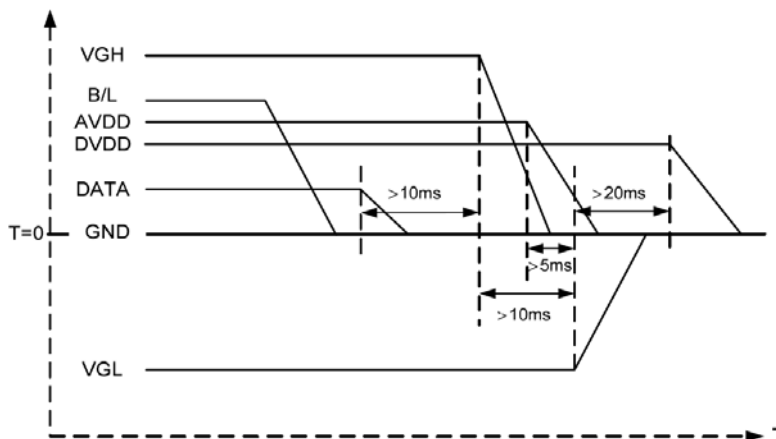

$\text{B/L} \rightarrow \text{Data} \rightarrow V_{GH} \rightarrow V_{GL} \rightarrow DV_{DD}$

**Note:** Data include R0~R7, B0~B7, GO~G7, U/D, L/R, DCLK, HS, VS, DE.

### 3.3 Timing Characteristics

#### 3.3.1 AC Electrical Characteristics

Item	Symbol	Values			Unit	Remark
		Min.	Typ.	Max.		
HS Setup Time	T <sub>hst</sub>	8	--	--	ns	
HS Hold Time	T <sub>hhd</sub>	8	--	--	ns	
VS Setup Time	T <sub>vst</sub>	8	--	--	ns	
VS Hold Time	T <sub>vhd</sub>	8	--	--	ns	
Data Setup Time	T <sub>dsu</sub>	8	--	--	ns	
Data Hold Time	T <sub>dhd</sub>	8	--	--	ns	
DE Setup Time	T <sub>esu</sub>	8	--	--	ns	
DE Hold Time	T <sub>ehd</sub>	8	--	--	ns	
DV <sub>DD</sub> Power On Slew Time	TPOR	--	--	20	ms	From 0 to 90% DV <sub>DD</sub>
Reset Pulse Width	T <sub>Rst</sub>	1	--	--	ms	
DCLK Cycle Time	T <sub>coh</sub>	20	--	--	ns	
DCLK Pulse Duty	T <sub>cwh</sub>	40	50	60	%	

3.3.2 Data Input Format



Figure 3.1 Horizontal input timing diagram.

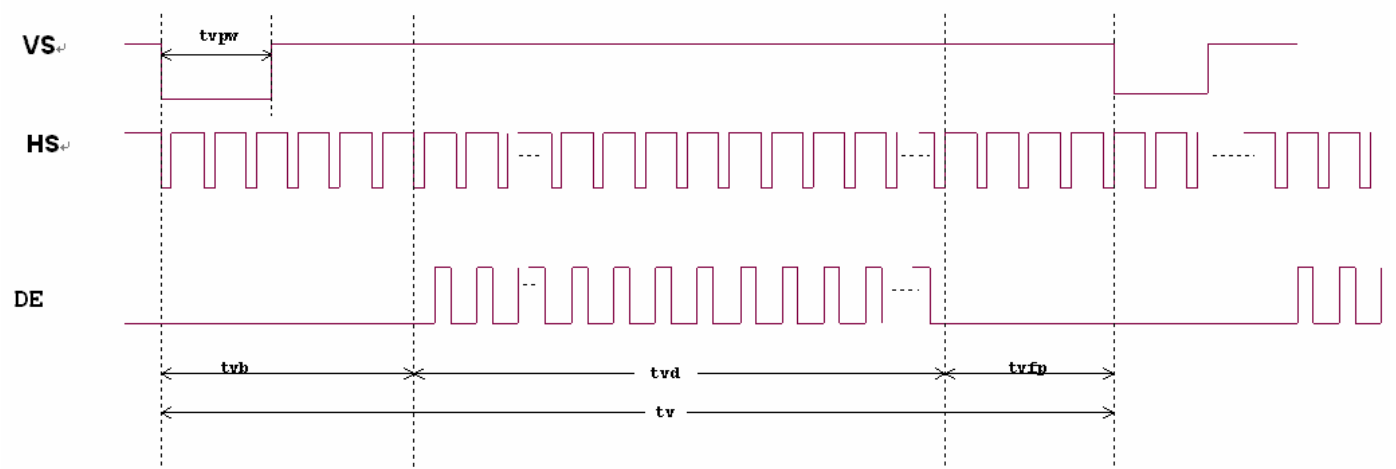

Figure 3.2 Vertical input timing diagram.

**3.3.3 Timing**

Item	Symbol	Values			Unit	Remark
		Min.	Typ.	Max.		
Horizontal Display Area	thd	--	800	--	DCLK	
DCLK Frequency	fclk	26.4	33.3	46.8	MHz	
One Horizontal Line	th	862	1056	1200	DCLK	
HS Pulse Width	thpw	1	--	40	DCLK	
HS Blanking	thb	46	46	46	DCLK	
HS Front Porch	thfp	16	210	354	DCLK	

Item	Symbol	Values			Unit	Remark
		Min.	Typ.	Max.		
Vertical Display Area	tvd	--	480	--	TH	
VS Period Time	tv	510	525	650	TH	
VS Pulse Width	tvpw	1	--	20	TH	
VS Blanking	tvb	23	23	23	TH	
VS Front Porch	tvfp	7	22	147	TH	

4.0 OPTICAL SPECIFICATIONS

Item	Symbol	Condition	Values			Unit	Remark
			Min.	Typ.	Max.		
Viewing Angle (CR ≥ 10)	$\theta_L$	$\Phi=180^\circ$ (9 O'CLOCK)	60	70	--	degree	Note 1
	$\theta_R$	$\Phi=0^\circ$ (3 O'CLOCK)	60	70	--		
	$\theta_T$	$\Phi=90^\circ$ (12 O'CLOCK)	60	70	--		
	$\theta_B$	$\Phi=270^\circ$ (6 O'CLOCK)	40	50	--		
Response Time	$T_{ON}$	Normal $\Theta=\Phi=0^\circ$	--	10	20	msec	Note 3
	$T_{OFF}$		--	15	30	msec	Note 3
Contrast Ratio	CR		400	500	--	--	Note 4
Color Chromaticity	$W_X$		--	0.31	--	--	Note 2
	$W_Y$		--	0.33	--	--	Note 5 Note 6
Luminance	L		850	--	--	cd/m <sup>2</sup>	Note 6
Luminance Uniformity	YU		75	80	--	%	Note 7

Test Conditions:

1. IL=330mA (Backlight current), the ambient temperature is 25°C.
2. The test systems refer to Note 2.

Note 1: Definition of viewing angle range

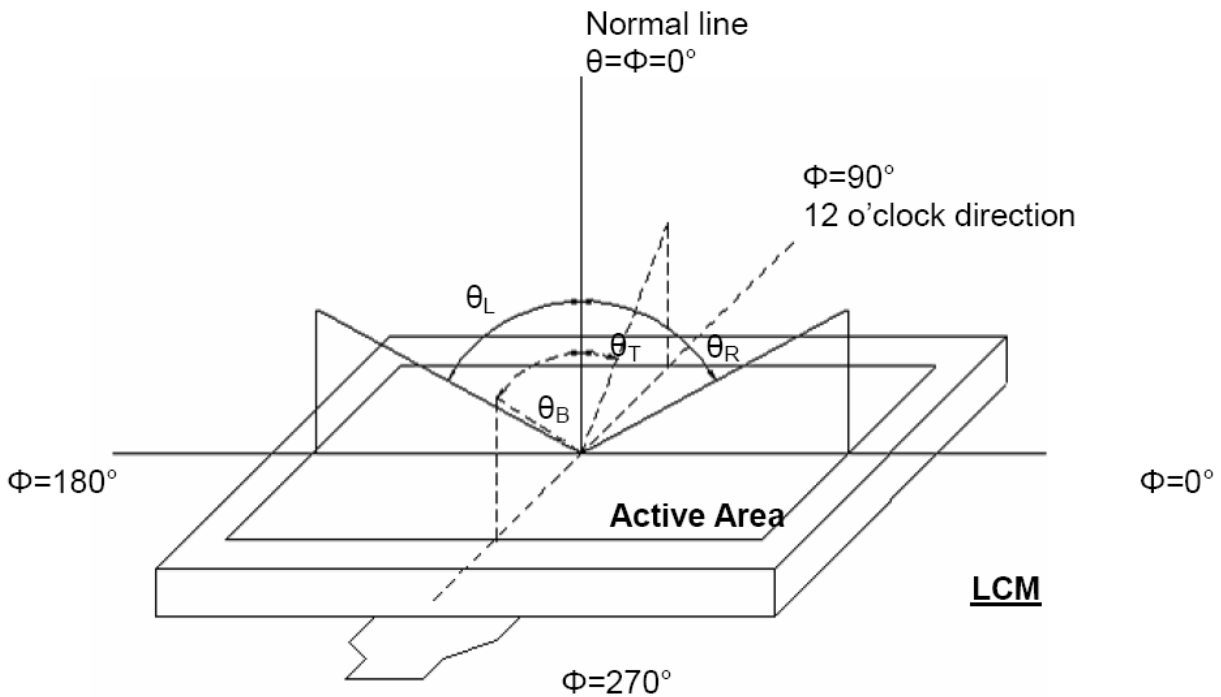

Figure 4.1 Definition of viewing angle.

**Note 2:** Definition of optical measurement system.

The optical characteristics should be measured in dark room. After 30 minutes operation, the optical properties are measured at the center point of the LCD screen. (Response time is measured by Photo detector TOPCON)

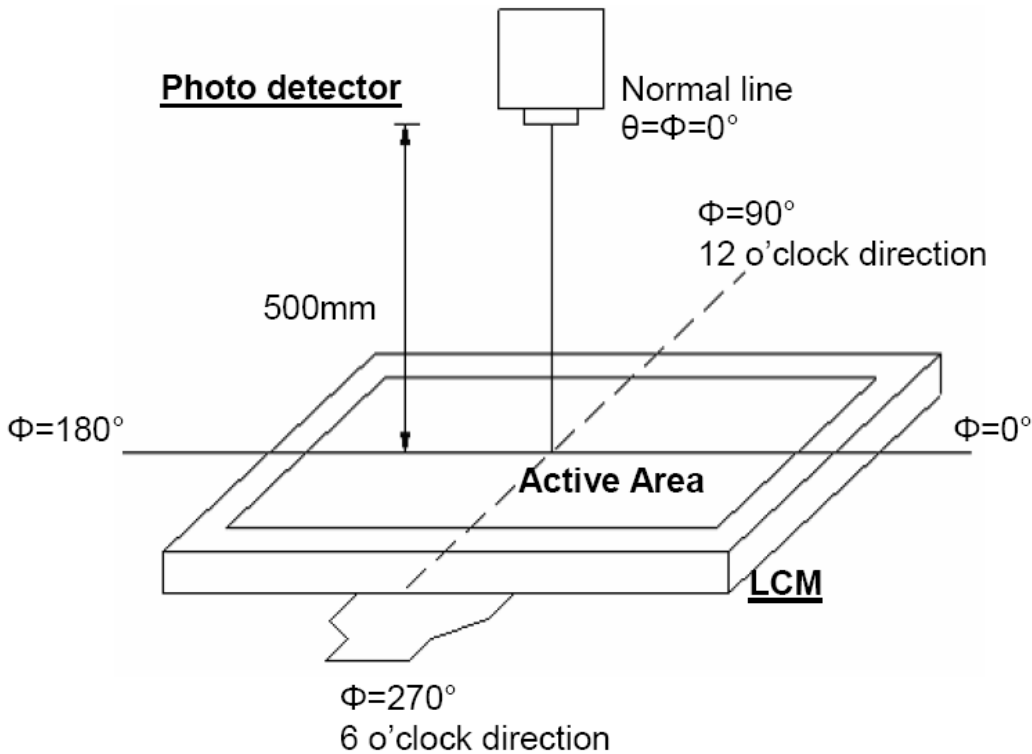

Figure 4.2 Optical measurement system setup

**Note 3:** Definition of Response time

The response time is defined as the LCD optical switching time interval between "White" state and "Black" state. Rise time ( $T_{ON}$ ) is the time between photo detector output intensity changed from 90% to 10%. And fall time ( $T_{OFF}$ ) is the time between photo detector output intensity changed from 10% to 90%.

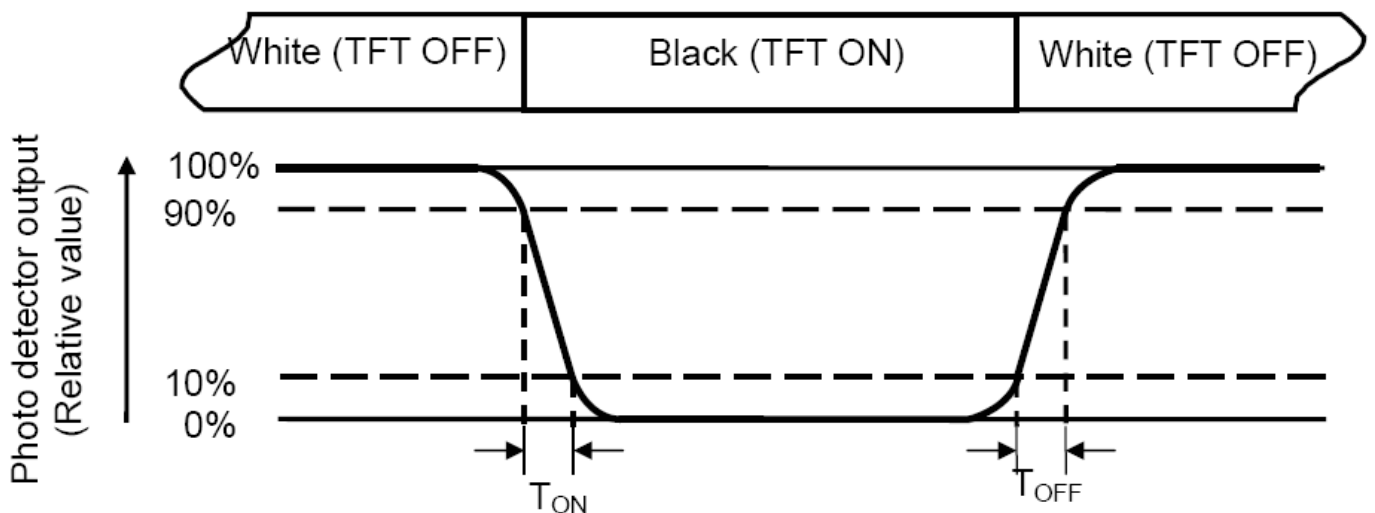

Figure 4.3 Definition of response.

**Note 4:** Definition of contrast ratio

$$\text{Contrast ratio(CR)} = \frac{\text{Luminance measured when LCD on the "white" state}}{\text{Luminance measured when LCD on the "black" state}}$$

**Note 5:** Definition of color chromaticity (CIE1931)

Color coordinates measured at center point of LCD.

**Note 6:** All input terminals LCD panel must be ground while measuring the center area of the panel.

**Note 7:** Definition of Luminance Uniformity

Active area is divided into 9 measuring areas (Refer to Fig. 4-4 ).Every measuring point is placed at the center of each measuring area.

$$\text{Luminance Uniformity (Yu)} = \frac{B_{min}}{B_{max}}$$

L-----Active area length      W----- Active area width

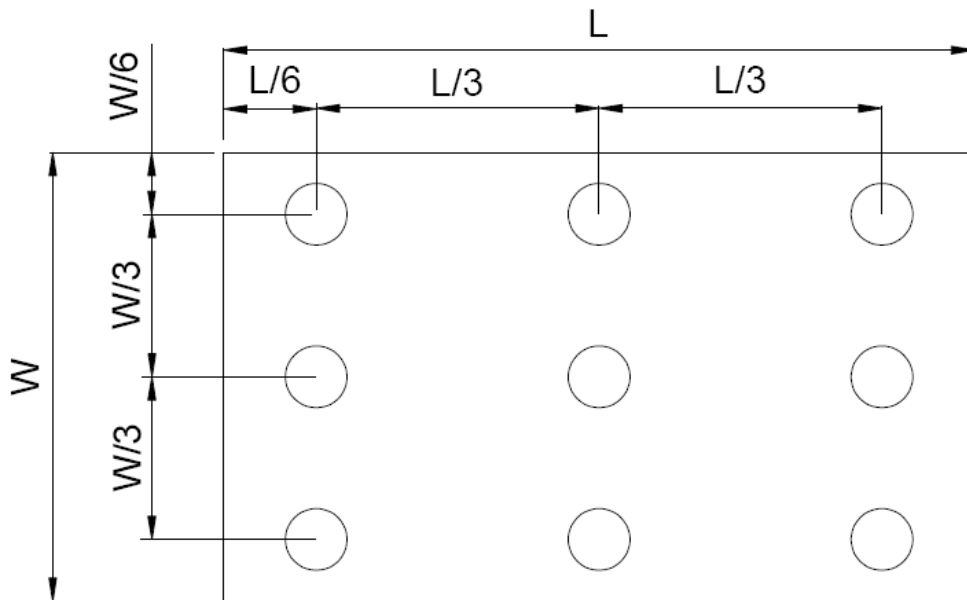

Figure 4.3 Definition of measuring points.

Bmax: The measured maximum luminance of all measurement position.

Bmin: The measured minimum luminance of all measurement position.

## 5. RELIABILITY TEST

Item	Test Condition Item	Remark
High temperature storage	Ta= 80 °C 96hrs	Note 1 Note 4
Low temperature storage	Ta=-30 °C 96hrs	Note 1 Note 4
High temperature operation	Ts= 70 °C 96hrs	Note 2 Note 4
Low temperature operation	Ts=-20 °C 96hrs	Note 1 Note 4
High temperature/High humidity operation	90% RH 60°C 96hrs	Note 4
Thermal Shock	-30°C/30 min ~ +80°C/30 min for a total 100 cycles, Start with cold temperature and end with high temperature.	Note 4
Vibration test	Freq:10~55~10Hz Amplitude:1.5mm 2 hours for each direction of X,Y,Z (6 hours for total)	
Mechanical shock	100G 6ms,±X, ±Y, ±Z 3 times for each direction	
Package vibration test	Random Vibration : 0.015G*G/Hz from 5-200HZ, -6dB/Octave from 200-500HZ 2 hours for each direction of X. Y. Z. (6 hours for total)	
Package drop test	Height:60 cm 1 corner, 3 edges, 6 surfaces	
Electro static discharge	± 2KV, Human Body Mode, 100pF/1500Ω	

**Note 1:** Ta is the ambient temperature of samples.

**Note 2:** Ts is the temperature of panel's surface.

**Note 3:** In the standard condition, there shall be no practical problem that may affect the display function. After the reliability test, the product only guarantees operation, but don't guarantee all of the cosmetic specification.

**Note 4:** Before cosmetic and function test, the product must have enough recovery time, at least 2 hours at room temperature.



## 6. PRECAUTION FOR USING LCM

1. When design the product with this LCD Module, make sure the viewing angle matches to its purpose of usage.
2. As LCD panel is made of glass substrate, Dropping the LCD module or banging it against hard objects may cause cracking or fragmentation. Especially at corners and edges.
3. Although the polarizer of this LCD Module has the anti-glare coating, always be careful not to scratch its surface. Use of a plastic cover is recommended to protect the surface of polarizer.
4. If the LCD module is stored at below specified temperature, the LC material may freeze and be deteriorated. If it is stored at above specified temperature, the molecular orientation of the LC material may change to Liquid state and it may not revert to its original state. Excessive temperature and humidity could cause polarizer peel off or bubble. Therefore, the LCD module should always be stored within specified temperature range.
5. Saliva or water droplets must be wiped off immediately as those may leave stains or cause color changes if remained for a long time. Water vapor will cause corrosion of ITO electrodes.
6. If the surface of LCD panel needs to be cleaned, wipe it swiftly with cotton or other soft cloth. If it is not still clean enough, blow a breath on the surface and wipe again.
7. The module should be driven according to the specified ratings to avoid malfunction and permanent damage. Applying DC voltage cause a rapid deterioration of LC material. Make sure to apply alternating waveform by continuous application of the M signal. Especially the power ON/OFF sequence should be kept to avoid latch-up of driver LSIs and DC charge up to LCD panel.
8. Mechanical Considerations
  - a) LCM are assembled and adjusted with a high degree of precision. Avoid excessive shocks and do not make any alterations or modifications. The following should be noted.
  - b) Do not tamper in any way with the tabs on the metal frame.
  - c) Do not modify the PCB by drilling extra holes, changing its outline, moving its components or modifying its pattern.

### 9. Static Electricity

#### a) Operator

Wear the electrostatics shielded clothes because human body may be statically charged if not ware shielded clothes. Never touch any of the conductive parts such as the LSI pads; the copper leads on the PCB and the interface terminals with any parts of the human body.

#### b) Equipment

There is a possibility that the static electricity is charged to the equipment, which has a function of peeling or friction action (ex: conveyer, soldering iron, working table). Earth the equipment through proper resistance (electrostatic earth:  $1 \times 10^8$  ohm).

Only properly grounded soldering irons should be used.

If an electric screwdriver is used, it should be well grounded and shielded from commutator sparks.

The normal static prevention measures should be observed for work clothes and working benches; for the latter conductive (rubber) mat is recommended.

#### c) Floor

Floor is the important part to drain static electricity, which is generated by operators or equipment.

There is a possibility that charged static electricity is not properly drained in case of insulating floor. Set the electrostatic earth (electrostatic earth:  $1 \times 10^8$  ohm).

#### d) Humidity

Proper humidity helps in reducing the chance of generating electrostatic charges. Humidity should be kept over 50%RH.

#### e) Transportation/storage

The storage materials also need to be anti-static treated because there is a possibility that the human body or storage materials such as containers may be statically charged by friction or peeling.

The modules should be kept in antistatic bags or other containers resistant to static for storage.

#### f) Soldering

Soldering anything to this TFT display would void the warranty.

#### g) Others

The laminator (protective film) is attached on the surface of LCD panel to prevent it from scratches or stains. It should be peeled off slowly using static eliminator.

Static eliminator should also be installed to the workbench to prevent LCD module from static charge.

### 10. Operation

- a) Driving voltage should be kept within specified range; excess voltage shortens display life.
- b) Response time increases with decrease in temperature.
- c) Display may turn black or dark blue at temperatures above its operational range; this is (however not pressing on the viewing area) may cause the segments to appear "fractured".
- d) Mechanical disturbance during operation (such as pressing on the viewing area) may cause the segments to appear "fractured".

## ATM0700D6J-CT(AZ DISPLAYS)TFT MODULE VER1.0

---

11. If any fluid leaks out of a damaged glass cell, wash off any human part that comes into contact with soap and water. The toxicity is extremely low but caution should be exercised at all the time.
12. Disassembling the LCD module can cause permanent damage and it should be strictly avoided.
13. LCD retains the display pattern when it is applied for long time (Image retention). To prevent image retention, do not apply the fixed pattern for a long time. Image retention is not a deterioration of LCD. It will be removed after display pattern is changed.
14. Do not use any materials, which emit gas from epoxy resin (hardener for amine) and silicone adhesive agent (dealcohol or deoxym) to prevent discoloration of polarizer due to gas.
15. Avoid the exposure of the module to the direct sunlight or strong ultraviolet light for a long time.

7. MECHANICAL DRAWING

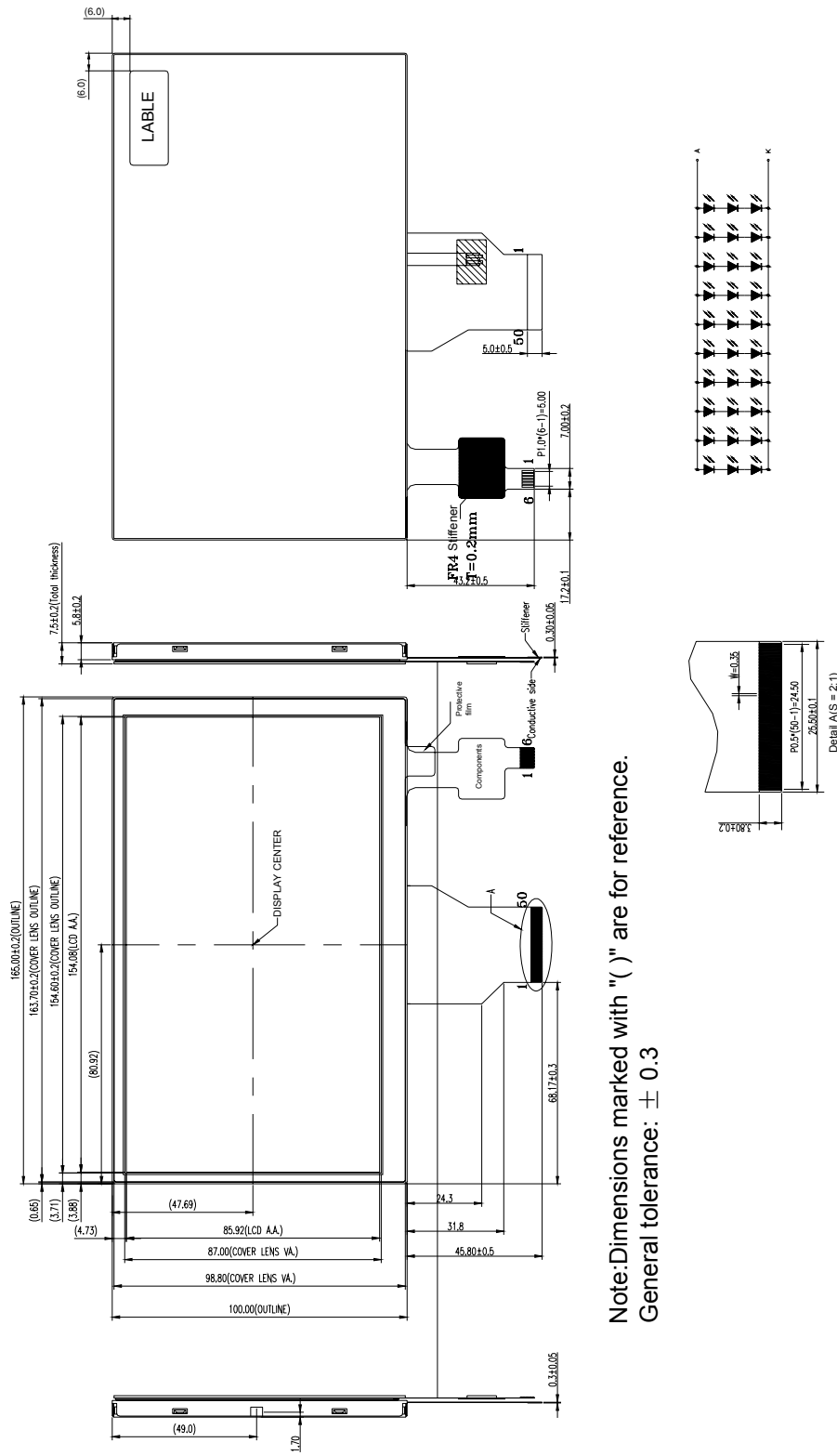

Note: Dimensions marked with "( )" are for reference.  
General tolerance: ± 0.3

**8. PACKAGE DRAWING**

Paper board 1PCS

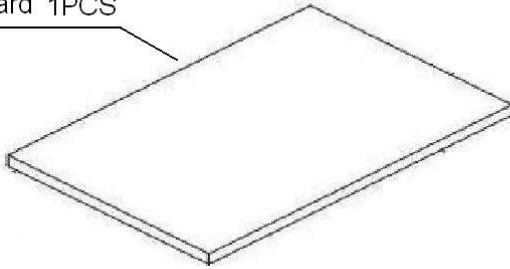

Module in AS bags, total 40pcs/box

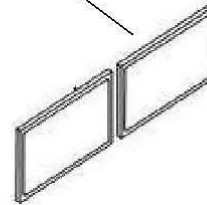

EPE 2PCS

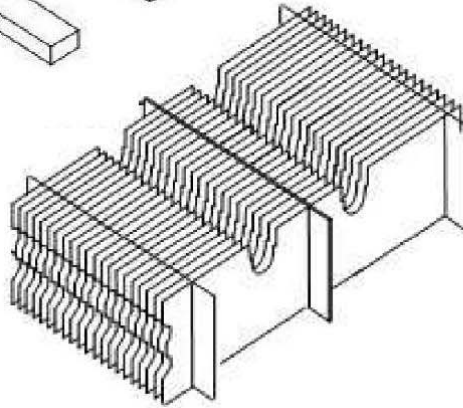
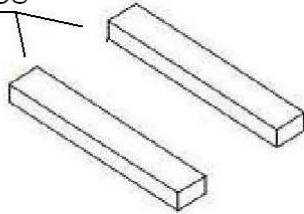

EPE 1PCS

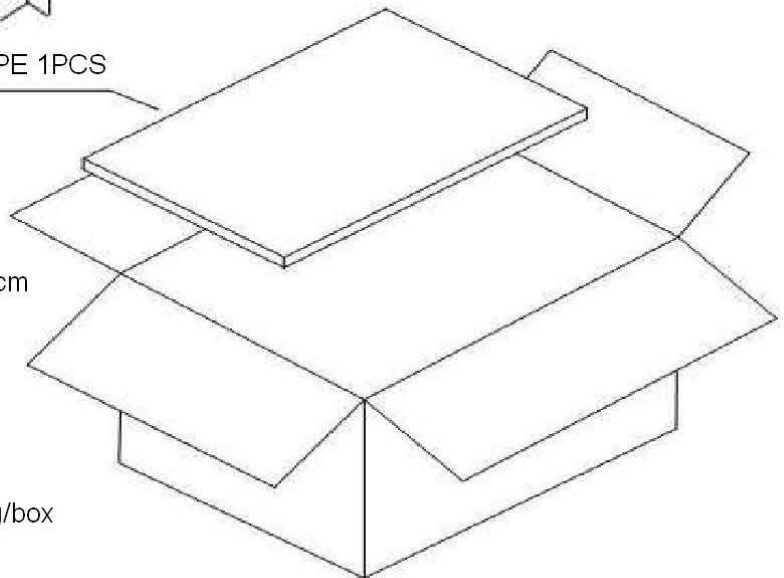

Outer box: 44x33x18cm

Total weight: 7.4Kg/box

**9. INSPECTION SPECIFICATION**

**1. SCOPE SPECIFICATIONS CONTAIN**

- 1.1 DISPLAY QUALITY EVALUATION
- 1.2 MECHANICS SPECIFICATION

**2. SAMPLING PLAN**

UNLESS THERE IS OTHER AGREEMENT, THE SAMPLING PLAN FOR INCOMING INSPECTION SHALL FOLLOW MIL-STD-105E.

- 2.1 LOT SIZE: QUANTITY PER SHIPMENT AS ONE LOT (DIFFERENT MODEL AS DIFFERENT LOT ).
- 2.2 SAMPLING TYPE: NORMAL INSPECTION, SINGLE SAMPLING.
- 2.3 SAMPLING LEVEL: LEVEL II.
- 2.4 AQL: ACCEPTABLE QUALITY LEVEL
  - MAJOR DEFECT: AQL=0.65
  - MINOR DEFECT: AQL=1.0

**3. PANEL INSPECTION CONDITION**

- 3.1 ENVIRONMENT:
  - ROOM TEMPERATURE: 25±5°C.
  - HUMIDITY: 65±5% RH.
  - ILLUMINATION: 300 ~ 700 LUX.
- 3.2 INSPECTION DISTANCE:
  - 35±5 CM
- 3.3 INSPECTION ANGLE:
  - THE VISION OF INSPECTOR SHOULD BE PERPENDICULAR TO THE SURFACE OF THE MODULE.
- 3.4 INSPECTION TIME:
  - PERCEPTIBILITY TEST TIME: 20 SECONDS MAX.

**4. DISPLAY QUALITY**



- 4.1 FUNCTION RELATED:
  - THE FUNCTION DEFECTS OF LINE DEFECT, ABNORMAL DISPLAY, AND NO DISPLAY ARE CONSIDERED MAJOR DEFECTS.
- 4.2 BRIGHT/DARK DOTS:

Defect Type	Specification	Major	Minor
Bright Dots	$N \leq 2$		•
Dark Dots	$N \leq 3$		•
Total Bright and Dark Dots	$N \leq 4$		•

Note: 1:

The definition of dot: The size of a defective dot over 1/2 of whole dot is regarded as one defective dot.  
 Bright dot: Dots appear bright and unchanged in size in which LCD panel is displaying under black pattern.  
 The bright dot defect must be visible through 2% ND filter  
 Dark dot: Dots appear dark and unchanged in size in which LCD panel is displaying under pure red, green, blue pattern.

4.3 Pixel Definition:

R	G	B	R	G	B	R	G	B			Dot Defect
R	G	B	R	G	B	R	G	B			Adjacent Dot Defect
R	G	B	R	G	B	R	G	B			Cluster

Note 1:

If pixel or partial sub-pixel defects exceed 50% of the affected pixel or sub-pixel area, it shall be considered as 1 defect.

Note 2:

There should be no distinct non-uniformity visible through 2% ND Filter within 2 sec inspection times.

ATM0700D6J-CT(AZ DISPLAYS)TFT MODULE VER1.0

4.4 Visual Inspection specifications:

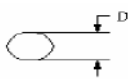
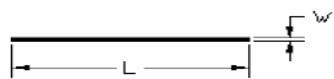
<u>Defect Type</u>		<u>Specification Size</u>	<u>Count(N)</u>	Major	Minor	
Dot Shape (Particle · Scratch and Bubbles in display area) 		$D \leq 0.25 \text{ mm}$	Ignored			
		$0.25\text{mm} < D \leq 0.5\text{mm}$	$N \leq 3$		•	
		$D > 0.5\text{mm}$	$N=0$			
Newton Ring (Only for Touch panel)		$D \leq 70\text{mm}$	$N \leq 4$		•	
		$D > 70\text{mm}$	$N=0$			
TSP Fish Eyes (Only for Touch panel) (Bubble/Dent)		$0.1\text{mm} < D \leq 0.2\text{mm}$	$N \leq 4$		•	
		$0.2\text{mm} < D \leq 0.3\text{mm}$	$N \leq 3$		•	
		$0.3 < D \leq 0.4$	$N \leq 2$			
Line Shape (Particles · Scratch · Lint and Bubbles in display area) 		$W \leq 0.01 \text{ mm}$	Ignored			
		$0.01\text{mm} < W \leq 0.05\text{mm}$ and $L \leq 3\text{mm}$	$N \leq 3$		•	
		$W > 0.05\text{mm}$ or $L > 3 \text{ mm}$	$N=0$			
Bubble in cell (active area)		It should be found by eyes			•	
Bezel	Scratch	No harm			•	
	Dirt				•	
	Wrap				•	
	Sunken				•	
Label	No label	No			•	
	Inverted label				•	
	Broken				•	
	Dirt			Word can be read.		•
	Not clear					•
	Word out of shape					•
	Mistake					•
	Position			Be attached on right position		•
Screw	Not enough	No			•	
	Limp	No			•	

ATM0700D6J-CT(AZ DISPLAYS)TFT MODULE VER1.0

---

Connector	Connection status	No bend on pins and damage		•
FPC/FFC	Broken	No		•

Note: Extraneous substance and scratch not affecting the display of image, for instance, extraneous substance under polarizer film but outside the display area, or scratch on metal bezel and backlight module or polarizer film outside the display area, shall not be considered as defective or non-conforming.