

General Purpose Transistors

NPN Silicon

These transistors are designed for general purpose amplifier applications. They are housed in the SC-89 package which is designed for low power surface mount applications.

Features

- Pb-Free Packages are Available
- S- Prefix for Automotive and Other Applications Requiring Unique Site and Control Change Requirements; AEC-Q101 Qualified and PPAP Capable.

MAXIMUM RATINGS ($T_A = 25^\circ\text{C}$)

Rating	Symbol	Max	Unit
Collector-Emitter Voltage	V_{CEO}	45	V
Collector-Base Voltage	V_{CBO}	50	V
Emitter-Base Voltage	V_{EBO}	6.0	V
Collector Current – Continuous	I_C	100	mAdc

THERMAL CHARACTERISTICS

Characteristic	Symbol	Max	Unit
Total Device Dissipation, FR-4 Board (Note 1) $T_A = 25^\circ\text{C}$ Derated above 25°C	P_D	200	mW
Thermal Resistance, Junction-to-Ambient (Note 1)	$R_{\theta JA}$	600	$^\circ\text{C}/\text{W}$
Total Device Dissipation, FR-4 Board (Note 2) $T_A = 25^\circ\text{C}$ Derated above 25°C	P_D	300	mW
Thermal Resistance, Junction-to-Ambient (Note 2)	$R_{\theta JA}$	400	$^\circ\text{C}/\text{W}$
Junction and Storage Temperature Range	T_J, T_{stg}	-55 to +150	$^\circ\text{C}$

1. FR-4 @ min pad.
2. FR-4 @ 1.0×1.0 in pad.

ORDERING INFORMATION

Device	Marking	Package	Shipping†
LBC847ATT1G S-LBC847ATT1G	1E	SC-89	3,000 / Tape & Reel
LBC847BTT1G S-LBC847BTT1G	1F	SC-89	3,000 / Tape & Reel
LBC847CTT1G S-LBC847CTT1G	1G	SC-89	3,000 / Tape & Reel

LBC847ATT1G
S-LBC847ATT1G
Series

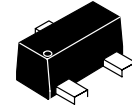

SC-89

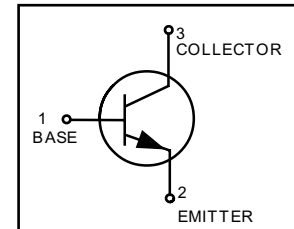

LBC847ATT1G Series
S-LBC847ATT1G Series

ELECTRICAL CHARACTERISTICS ($T_A = 25^\circ\text{C}$ unless otherwise noted)

Characteristic	Symbol	Min	Typ	Max	Unit
OFF CHARACTERISTICS					
Collector–Emitter Breakdown Voltage ($I_C = 10\text{ mA}$)	LBC847 Series $V_{(BR)CEO}$	45	–	–	V
Collector–Emitter Breakdown Voltage ($I_C = 10\text{ }\mu\text{A}$, $V_{EB} = 0$)	LBC847 Series $V_{(BR)CES}$	50	–	–	V
Collector–Base Breakdown Voltage ($I_C = 10\text{ }\mu\text{A}$)	LBC847 Series $V_{(BR)CBO}$	50	–	–	V
Emitter–Base Breakdown Voltage ($I_E = 1.0\text{ }\mu\text{A}$)	LBC847 Series $V_{(BR)EBO}$	6.0	–	–	V
Collector Cutoff Current ($V_{CB} = 30\text{ V}$) ($V_{CB} = 30\text{ V}$, $T_A = 150^\circ\text{C}$)	I_{CBO}	–	–	15 5.0	nA μA
ON CHARACTERISTICS					
DC Current Gain ($I_C = 10\text{ }\mu\text{A}$, $V_{CE} = 5.0\text{ V}$)	LBC847A LBC847B LBC847C	–	90	–	–
($I_C = 2.0\text{ mA}$, $V_{CE} = 5.0\text{ V}$)	LBC847A LBC847B LBC847C	110 200 420	180 290 520	220 450 800	–
Collector–Emitter Saturation Voltage ($I_C = 10\text{ mA}$, $I_B = 0.5\text{ mA}$) ($I_C = 100\text{ mA}$, $I_B = 5.0\text{ mA}$)	$V_{CE(sat)}$	–	–	0.25 0.6	V
Base–Emitter Saturation Voltage ($I_C = 10\text{ mA}$, $I_B = 0.5\text{ mA}$) ($I_C = 100\text{ mA}$, $I_B = 5.0\text{ mA}$)	$V_{BE(sat)}$	–	0.7 0.9	–	V
Base–Emitter Voltage ($I_C = 2.0\text{ mA}$, $V_{CE} = 5.0\text{ V}$) ($I_C = 10\text{ mA}$, $V_{CE} = 5.0\text{ V}$)	$V_{BE(on)}$	580	660	700 770	mV
SMALL–SIGNAL CHARACTERISTICS					
Current–Gain – Bandwidth Product ($I_C = 10\text{ mA}$, $V_{CE} = 5.0\text{ Vdc}$, $f = 100\text{ MHz}$)	f_T	100	–	–	MHz
Output Capacitance ($V_{CB} = 10\text{ V}$, $f = 1.0\text{ MHz}$)	C_{obo}	–	–	4.5	pF
Noise Figure ($I_C = 0.2\text{ mA}$, $V_{CE} = 5.0\text{ Vdc}$, $R_S = 2.0\text{ k}\Omega$, $f = 1.0\text{ kHz}$, $BW = 200\text{ Hz}$)	NF	–	–	10	dB

LBC847ATT1G Series
S-LBC847ATT1G Series

LBC847ATT1G, LBC847BTT1G, LBC847CTT1G

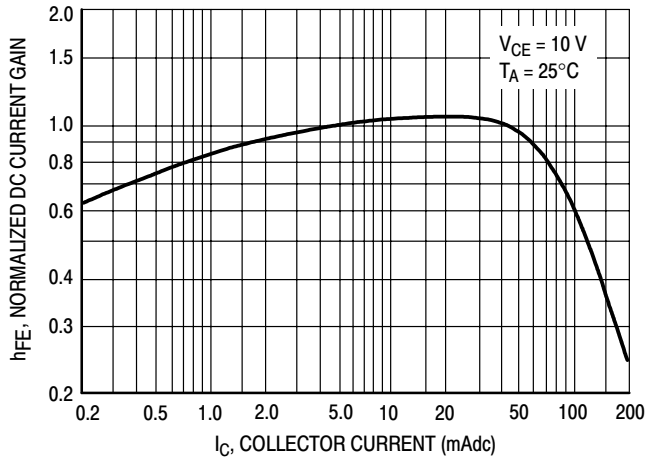

Figure 1. Normalized DC Current Gain

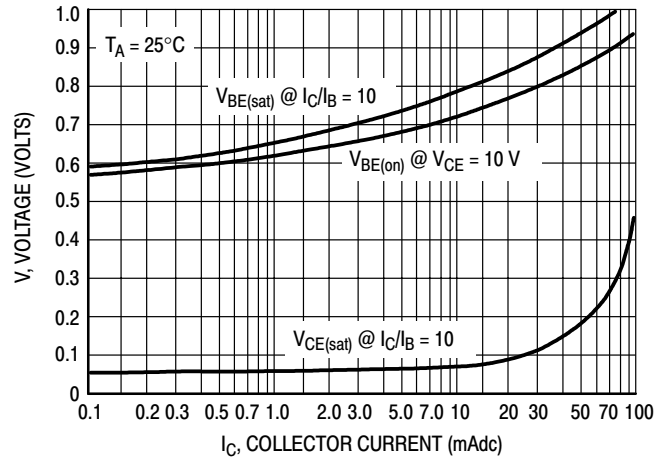

Figure 2. "Saturation" and "On" Voltages

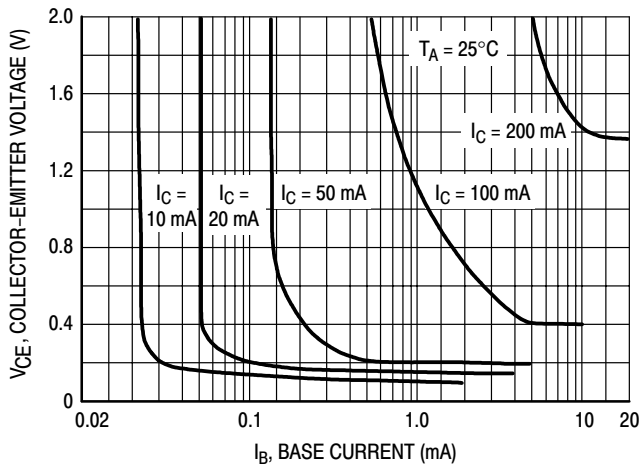

Figure 3. Collector Saturation Region

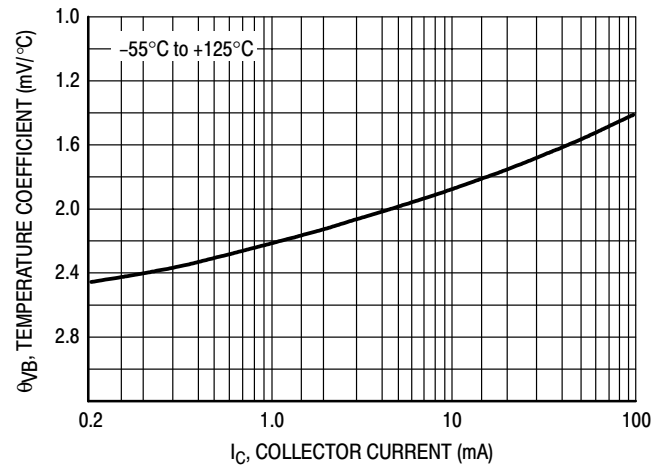

Figure 4. Base-Emitter Temperature Coefficient

LBC847ATT1G Series
S-LBC847ATT1G Series

LBC847ATT1G, LBC847BTT1G, LBC847CTT1G

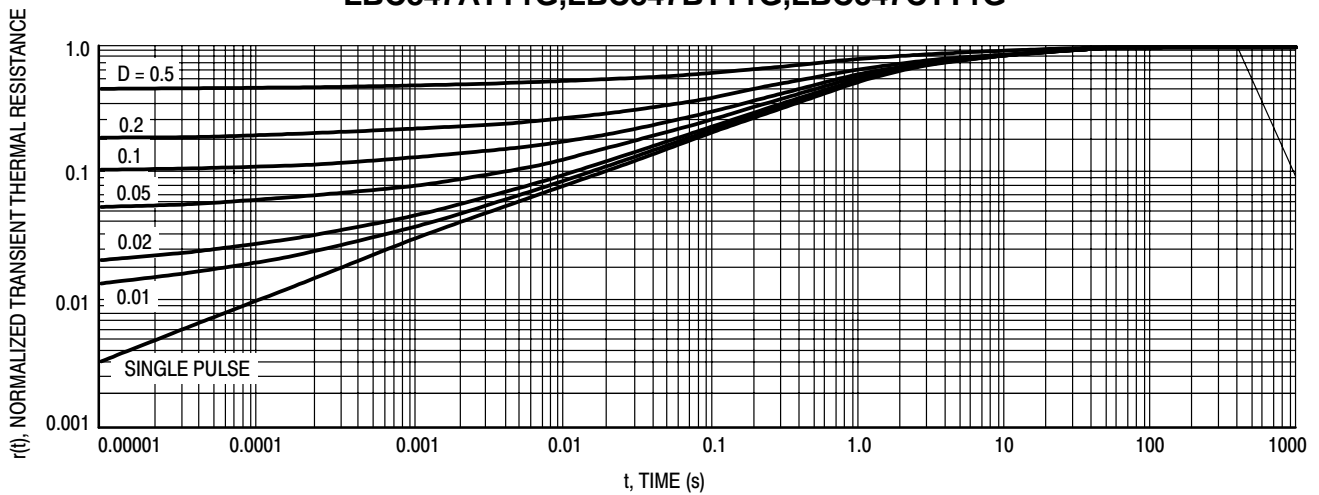

Figure 5. Normalized Thermal Response

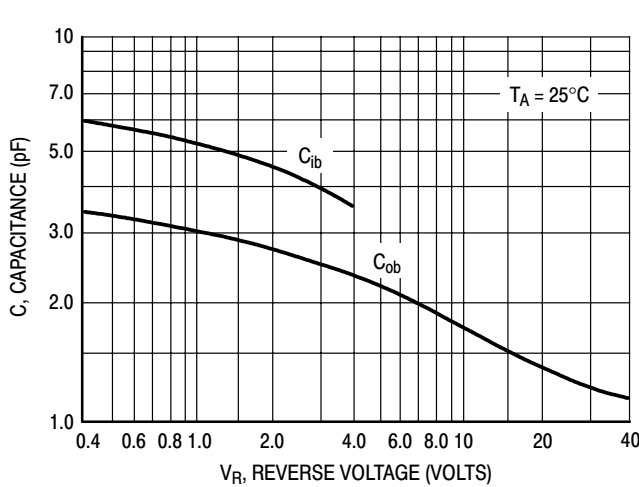

Figure 6. Capacitances

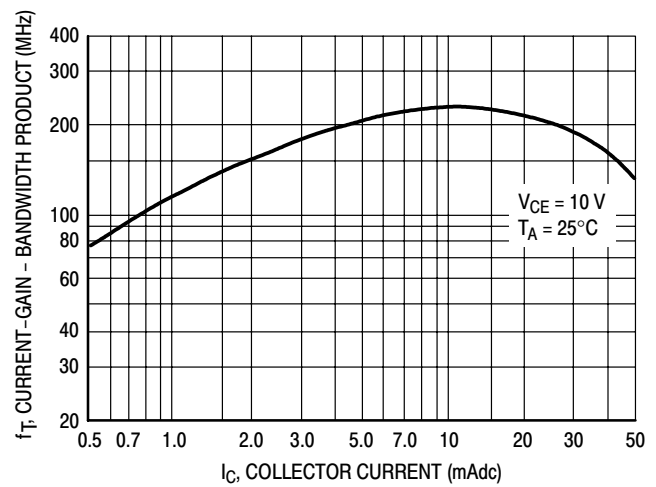
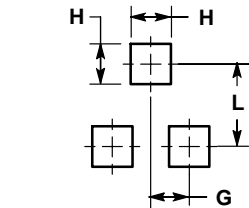
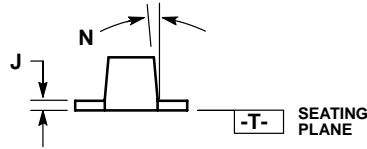
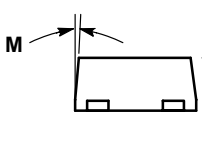
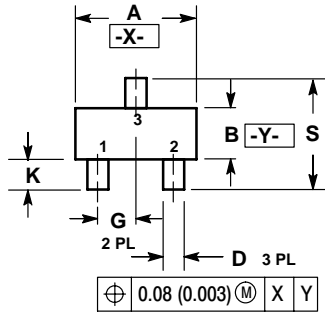

Figure 7. Current-Gain - Bandwidth Product

LBC847ATT1G Series
S-LBC847ATT1G Series

SC-89



RECOMMENDED PATTERN OF SOLDER PADS

NOTES:

1. DIMENSIONING AND TOLERANCING PER ANSI Y14.5M, 1982.
2. CONTROLLING DIMENSION: MILLIMETERS
3. MAXIMUM LEAD THICKNESS INCLUDES LEAD FINISH THICKNESS. MINIMUM LEAD THICKNESS IS THE MINIMUM THICKNESS OF BASE MATERIAL.
4. 463C-01 OBSOLETE, NEW STANDARD 463C-02.

DIM	MILLIMETERS			INCHES		
	MIN	NOM	MAX	MIN	NOM	MAX
A	1.50	1.60	1.70	0.059	0.063	0.067
B	0.75	0.85	0.95	0.030	0.034	0.040
C	0.60	0.70	0.80	0.024	0.028	0.031
D	0.23	0.28	0.33	0.009	0.011	0.013
G	0.50 BSC			0.020 BSC		
H	0.53 REF			0.021 REF		
J	0.10	0.15	0.20	0.004	0.006	0.008
K	0.30	0.40	0.50	0.012	0.016	0.020
L	1.10 REF			0.043 REF		
M	---	---	10 °	---	---	10 °
N	---	---	10 °	---	---	10 °
S	1.50	1.60	1.70	0.059	0.063	0.067