



300mA ULTRA LOW DROPOUT POSITIVE ADJUSTABLE AND FIXED REGULATORS

FEATURES

- SOT-23-5 Package
- Stable with 2.2µF Ceramic Capacitor
- 2% Voltage Reference Accuracy
- Only 320mV Dropout at 300mA and 170mV Dropout at 150mA
- 5µA Quiescent Current in Shutdown
- Current Limit and Thermal Shutdown
- Logic Input Enable Pin
- RoHS Compliant

APPLICATIONS

- Laptop, Notebook & Palmtop computers
- Battery Powered Equipments
- PCMCIA Vcc & Vpp Regulator
- Consumer Electronics
- High Efficiency Linear Power Supplies

DESCRIPTION

The APU8836 device is an efficient linear voltage regulator with better than 2% initial voltage accuracy, very low dropout voltage and very low ground current designed especially for hand held, battery powered applications. Other features of the device are: TTL compatible enable/shutdown control input, current limiting and thermal shutdown.

The APU8836 is available in adjustable output voltage versions in a small SOT-23 5-Pin package.

TYPICAL APPLICATION

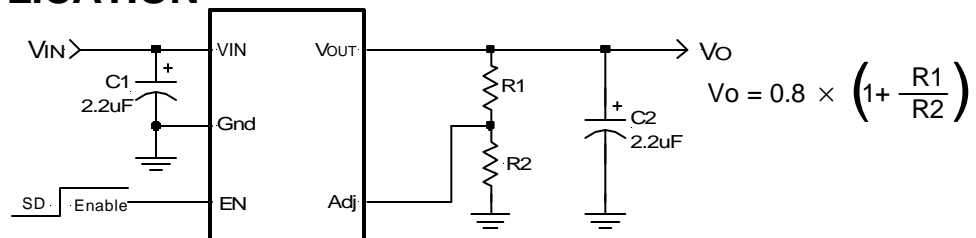
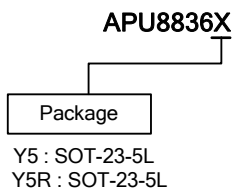

Figure 1 - Typical application of the APU8836 adjustable voltage regulator.

PACKAGE ORDER INFORMATION



ABSOLUTE MAXIMUM RATINGS

Input Voltage (V_{IN})	10V
Enable Input Voltage	10V
Storage Temperature Range	-65°C To 150°C
Operating Junction Temperature Range	0°C To 150°C
Junction Temperature Range	0°C To 125°C

PACKAGE INFORMATION

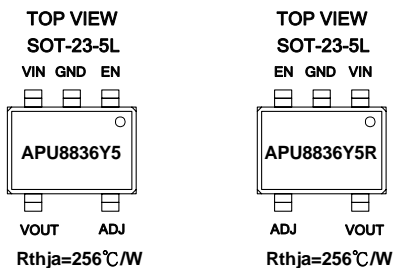

ELECTRICAL SPECIFICATIONS

Unless otherwise specified, these specifications apply over $C_{IN}=C_O=2.2\mu F$, $I_O=100\mu A$, $V_{IN(MIN)}=2.5V$ (Adjustable devices), $V_{OUT}=V_{FB}$ (for adjustable version only), $V_{EN}=2V$ and $T_A=25^\circ C$. Typical values refer to $T_A=25^\circ C$. Low duty cycle pulse testing is used which keeps junction and case temperatures equal to the ambient temperature.

PARAMETER	SYM	TEST CONDITION	MIN	TYP	MAX	UNITS
Reference Voltage	V_O		-2		2	%
Line Regulation	ΔV_I	$V_O + 1V < V_{IN} < 10V$		0.005		%/V
Load Regulation (Note 1)	ΔV_L	$1mA < I_O < 300mA$		1.5		%
Dropout Voltage (Note 2)	$\Delta V_{I(O)}$	$I_O=100\mu A$		10		mV
		$I_O=150mA$		170		
		$I_O=300mA$		320		
Ground Current (Note 3)	I_Q	$V_{EN}=2V, I_O=1000\mu A$		120		μA
Ground Current-SD Activated	$I_{Q(SD)}$	$V_{EN}=0V$ to 0.8V or Open		5		μA
Current Limit	I_{CL}	$V_O=0V$	320	420		mA
Thermal Regulation	ΔV_P	$V_{IN}=10V, I_O=150mA, 10ms$ Pulse		0.05		%/W
Adjust Pin Current	I_{ADJ}	$V_{IN}=2.5V, V_O=V_{ADJ}$		0.1		μA
Enable Pin Input LO Voltage	$V_{EN(L)}$	Regulator OFF			0.8	V
Enable Pin Input HI Voltage	$V_{EN(H)}$	Regulator ON	2			V
Enable Pin Input LO Current		$V_{EN(L)}=0V$		0.1		μA
Enable Pin Input HI Current		$V_{EN(H)}=2V$		20		μA



Note 1: Low duty cycle pulse testing with Kelvin connections is required in order to maintain accurate data.

Note 2: Dropout voltage is defined as the minimum differential voltage between V_{IN} and V_{OUT} required to maintain regulation at V_{OUT} . It is measured when the output voltage drops below its nominal value.

Note 3: Ground current is the regulator quiescent current plus the pass transistor current. The total current from the supply is the sum of the load current plus the ground pin current.

PIN DESCRIPTIONS

PIN SYMBOL	PIN DESCRIPTION
V_{IN}	The input pin of the regulator. Typically a large storage capacitor is connected from this pin to ground to insure that the input voltage does not sag below the minimum drop out voltage during the load transient response. This pin must always be higher than V_{OUT} by at least the amount of the dropout voltage and some margin in order for the device to regulate properly.
Gnd	Ground pin. This pin must be connected to the lowest potential in the system and all other pins must be at higher potential with respect to this pin.
En	Enable pin. A low signal or left open on this pin shuts down the output. This pin must be tied HI or to V_{IN} for normal operation.
Adj (Adjustable Only)	A resistor divider from this pin to the V_{OUT} pin and ground sets the output voltage. To minimize the error due to the error amplifier, select the values of the resistor dividers to be less than 10K Ω .
V_{OUT}	The output of the regulator. A minimum of 2.2 μ F with max ESR of 1 Ω capacitor must be connected from this pin to ground to insure stability.

BLOCK DIAGRAM

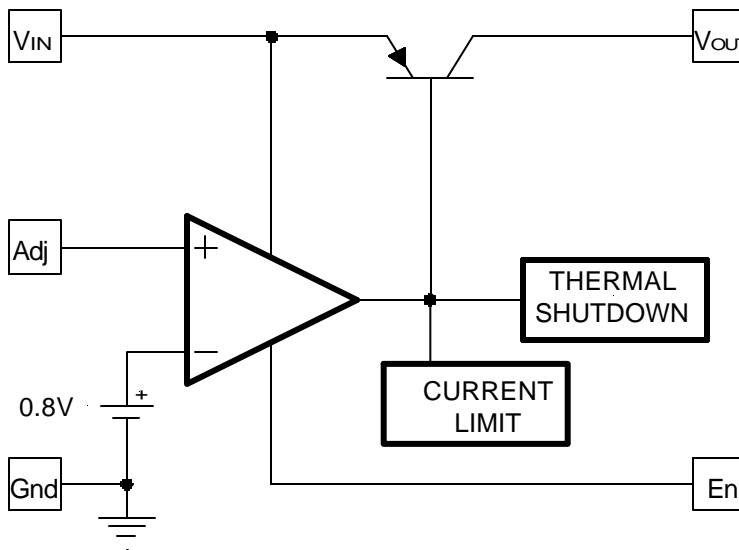
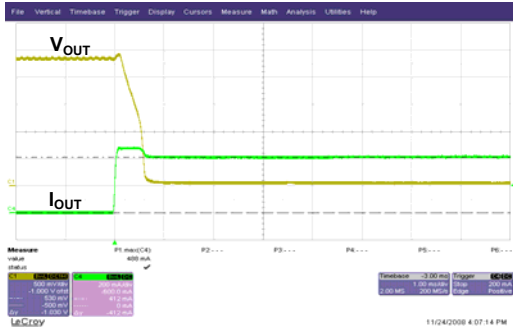

Figure 2 - APU8836 Adjustable output block diagram.



TYPICAL PERFORMANCE CHARACTERISTICS

Current Limit (V_{OUT} vs. I_{OUT})



$V_{IN}=3.5V$, $R_1/R_2=2K\Omega/1K\Omega$, $C_{IN}=C_{OUT}=2.2\mu F$ (EL Cap.)

Load Transient
 $I_{OUT}=0mA \sim 150mA$

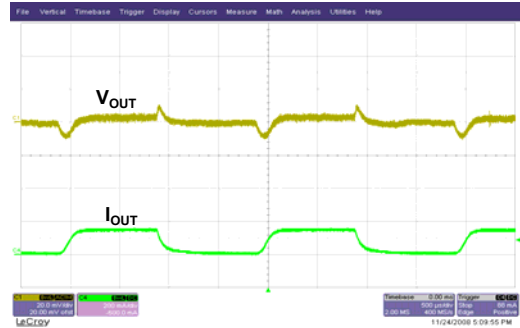

$V_{IN}=3.5V$, $R_1/R_2=2K\Omega/1K\Omega$, $C_{IN}=C_{OUT}=2.2\mu F$ (EL Cap.)
 $T_{on}=T_{off}=1mS$, $Rising=Falling=0.25A/uS$

Power Sequence

Power ON ($R_L=16\Omega$)

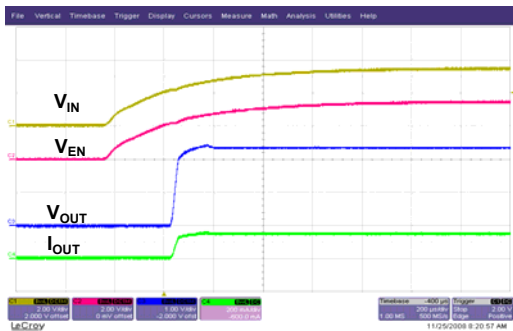

$V_{IN}=V_{EN}=3.5V$, $R_1/R_2=2K\Omega/1K\Omega$, $C_{IN}=C_{OUT}=2.2\mu F$ (EL Cap.)

Power OFF ($R_L=16\Omega$)

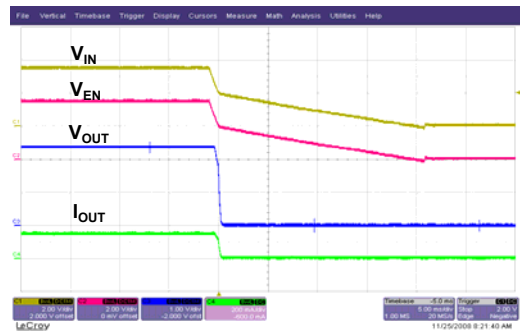

Power Sequence

Power ON ($R_L=8\Omega$)

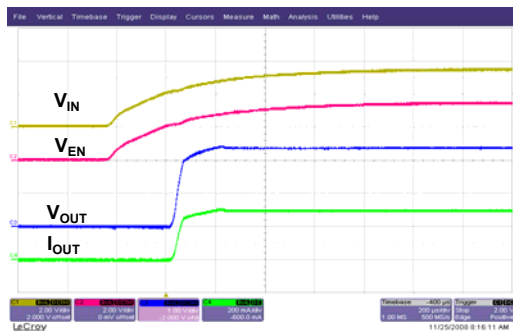

$V_{IN}=V_{EN}=3.5V$, $R_1/R_2=2K\Omega/1K\Omega$, $C_{IN}=C_{OUT}=2.2\mu F$ (EL Cap.)

Power OFF ($R_L=8\Omega$)

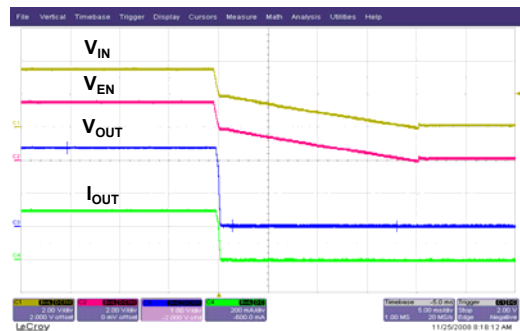



TYPICAL PERFORMANCE CHARACTERISTICS

Enable ON Sequence ($R_L=16\Omega$)
VEN=0V to 2V

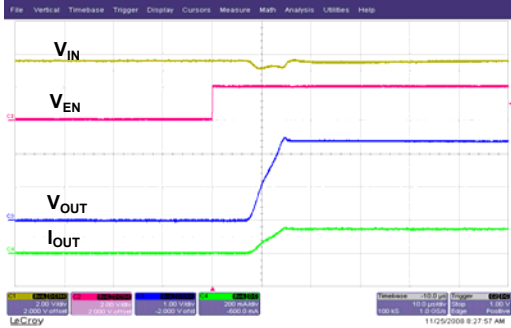

Enable OFF Sequence ($R_L=16\Omega$)
VEN=2V to 0V

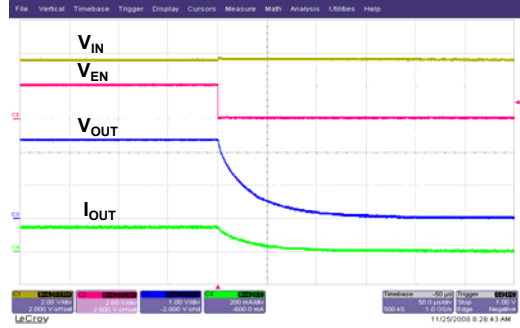

VIN=3.5V, R1/R2=2K Ω /1K Ω , CIN=COU=2.2uF(EL Cap.)

Enable ON Sequence ($R_L=8\Omega$)
VEN=0V to 2V

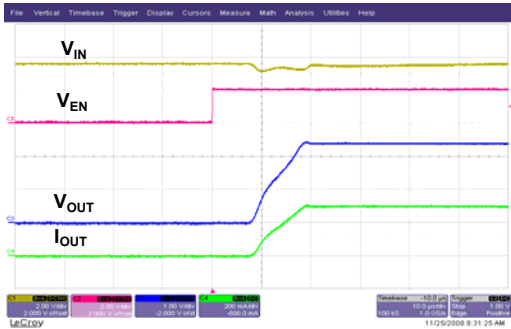

Enable OFF Sequence ($R_L=8\Omega$)
VEN=2V to 0V

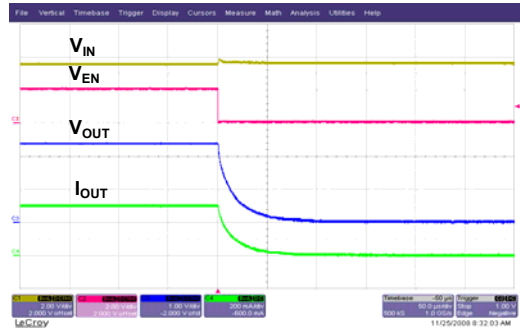

VIN=3.5V, R1/R2=2K Ω /1K Ω , CIN=COU=2.2uF(EL Cap.)



MARKING INFORMATION

SOT-23-5L

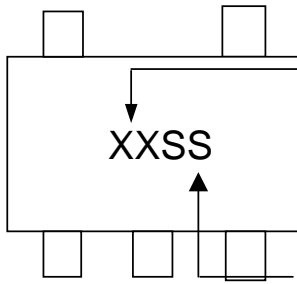

Part Number :

RS : APU8836Y5

rS : APU8836Y5R

Date Code : SS