

### Features

- ✧ For surface mounted applications in order to optimize board space
- ✧ Low profile package
- ✧ Built-in strain relief
- ✧ Glass passivated junction
- ✧ Low inductance
- ✧ Typical  $I_R$  less than 1uA above 11V
- ✧ High temperature soldering guaranteed: 260°C / 10 seconds at terminals
- ✧ Meet MSL level 1, per J-STD-020D, lead free maximum peak of 260°C
- ✧ Plastic package has Underwriters Laboratory Flammability Classification 94V-0
- ✧ Green compound with suffix "G" on packing code & prefix "G" on datecode

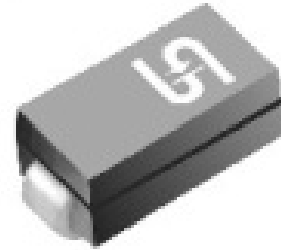

### Mechanical Data

- ✧ Case: Molded plastic over passivated junction
- ✧ Terminals: Pure tin plated lead free, solderable per MIL-STD-750, Method 2025
- ✧ Polarity: Color Band denotes positive end (cathode)
- ✧ Standard packaging: 12mm tape (EIA-481)
- ✧ Weight: 0.064 gram

### Ordering Information (example)

Part No.	Package	Packing	Packing code	Packing code (Green)
1SMA4737	SMA	1.8K / 7" REEL	R3	R3G

### Maximum Ratings and Electrical Characteristics

Rating at 25 °C ambient temperature unless otherwise specified.

Type Number	Symbol	Value	Unit
Power Dissipation, $R_{THJA} < 30K/W$ , $T_A = 60^\circ C$	$P_D$	3	Watts
Power Dissipation, $R_{THJA} < 100K/W$ , $T_A = 25^\circ C$	$P_D$	1.25	Watts
Non Repetitive Peak Power Dissipation (Note 1)	$P_{ZSM}$	60	Watts
Non Repetitive Peak Forward Surge Current, 8.3ms Single Half Sine-wave Superimposed on Rated Load (JEDEC method)	$I_{FSM}$	10	Amps
Operating and Storage Temperature Range	$T_J, T_{STG}$	-55 to +150	°C

Note 1: Non Repetitive Peak surge PD Test Condition:  $t_p = 100\mu s$  sq. pulse,  $T_A = 25^\circ C$  prior to surge

**ELECTRICAL CHARACTERISTICS (TA=25°C unless otherwise noted)**

Device (Note 1)	Device Marking code	Nominal Zener Voltage	Test Current	Zener Impedance			Leakage Current		Surge current T <sub>A</sub> =25°C
		V <sub>Z</sub> @I <sub>ZT</sub>	I <sub>ZT</sub>	Z <sub>ZT</sub> @I <sub>ZT</sub>	Z <sub>ZK</sub> @I <sub>ZK</sub>		I <sub>R</sub> @V <sub>R</sub>		I <sub>R</sub>
		V	mA	Ω	Ω	mA	μA	V	mA
		(Note 2) (Note 3)					Max.		
1SMA4737	737A	7.5	34	4	700	0.50	5	5.0	605
1SMA4738	738A	8.2	31	4.5	700	0.50	5	6.0	550
1SMA4739	739A	9.1	28	5	700	0.50	5	7.0	500
1SMA4740	740A	10	25	7	700	0.25	5	7.6	454
1SMA4741	741A	11	23	8	700	0.25	1	8.4	414
1SMA4742	742A	12	21	9	700	0.25	1	9.1	380
1SMA4743	743A	13	19	10	700	0.25	1	9.9	344
1SMA4744	744A	15	17	14	700	0.25	1	11.4	304
1SMA4745	745A	16	15.5	16	700	0.25	1	12.2	285
1SMA4746	746A	18	14.0	20	750	0.25	1	13.7	250
1SMA4747	747A	20	12.5	22	750	0.25	1	15.2	225
1SMA4748	748A	22	11.5	23	750	0.25	1	16.7	205
1SMA4749	749A	24	10.5	25	750	0.25	1	18.2	190
1SMA4750	750A	27	9.5	35	750	0.25	1	20.6	170
1SMA4751	751A	30	8.5	40	1000	0.25	1	22.8	150
1SMA4752	752A	33	7.5	45	1000	0.25	1	25.1	135
1SMA4753	753A	36	7.0	50	1000	0.25	1	27.4	125
1SMA4754	754A	39	6.5	60	1000	0.25	1	29.7	115
1SMA4755	755A	43	6.0	70	1500	0.25	1	32.7	110
1SMA4756	756A	47	5.5	80	1500	0.25	1	35.8	95
1SMA4757	757A	51	5.0	95	1500	0.25	1	38.8	90
1SMA4758	758A	56	4.5	110	2000	0.25	1	42.6	80
1SMA4759	759A	62	4.0	125	2000	0.25	1	47.1	70
1SMA4760	760A	68	3.7	150	2000	0.25	1	51.7	65
1SMA4761	761A	75	3.3	175	2000	0.25	1	56.0	60
1SMA4762	762A	82	3.0	200	3000	0.25	1	62.2	55
1SMA4763	763A	91	2.8	250	3000	0.25	1	69.2	50
1SMA4764	764A	100	2.5	350	3000	0.25	1	76.0	45
1SMA110Z	110A	110	2.3	450	4000	0.25	1	83.6	-
1SMA120Z	120A	120	2.0	550	4500	0.25	1	91.2	-
1SMA130Z	130A	130	1.9	700	5000	0.25	1	98.8	-
1SMA150Z	150A	150	1.7	1000	6000	0.25	1	114.0	-
1SMA160Z	160A	160	1.6	1100	6500	0.25	1	121.6	-
1SMA180Z	180A	180	1.4	1200	7000	0.25	1	136.8	-
1SMA200Z	200A	200	1.2	1500	8000	0.25	1	152.0	-

**Notes:**

1. Tolerance and Type Number Designation. The type numbers listed have a standard tolerance on the nominal zener voltage of ±5%
2. Specials Available Include:
  - A. Nominal zener voltages between the voltages shown and tighter voltage tolerances
  - B. Matched sets
3. Zener Voltage (V<sub>Z</sub>) Measurement. Guarantees the zener voltage when measured at 90 seconds while maintaining the lead temperature (T<sub>L</sub>) at 30°C ± 1°C, from the diode body
4. Zener Impedance (Z<sub>Z</sub>) Derivation. The zener impedance is derived from the 60 cycle AC voltage, which results when an ac current having an rms value equal to 10% of the DC zener current (I<sub>ZT</sub> or I<sub>ZK</sub>) is superimposed on I<sub>ZT</sub> or I<sub>ZK</sub>
5. Surge Current (I<sub>R</sub>) Non-Repetitive. The rating listed in the electrical characteristics table is maximum peak, non-repetitive, reverse surge current of 1/2 square wave or equivalent sine wave pulse of 1/120 second duration superimposed on the test current, I<sub>ZT</sub> per JEDEC registration; however, actual device capability is as described in Figure 10

RATINGS AND CHARACTERISTIC CURVES (1SMA4737 THRU 1SMA200Z)

FIG. 1 POWER TEMPERATURE DERATING CURVE

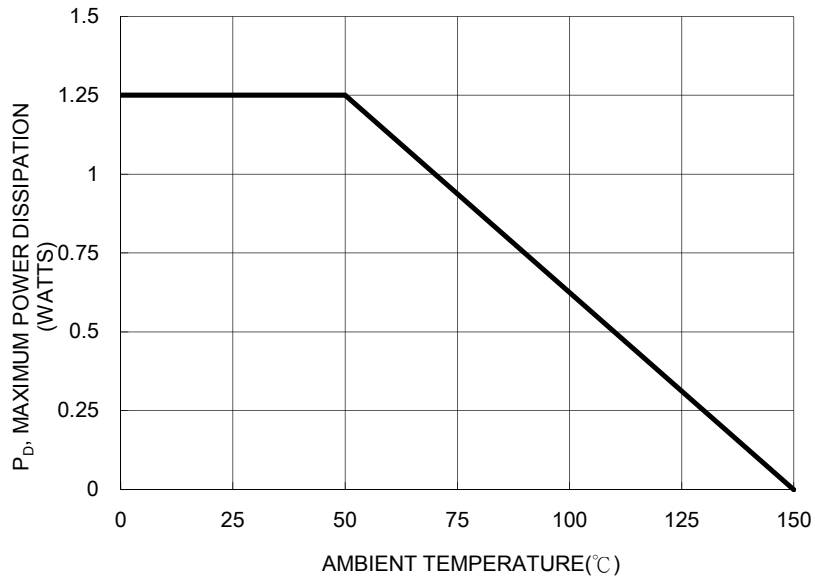

FIG. 2 TYPICAL FORWARD CHARACTERISTICS

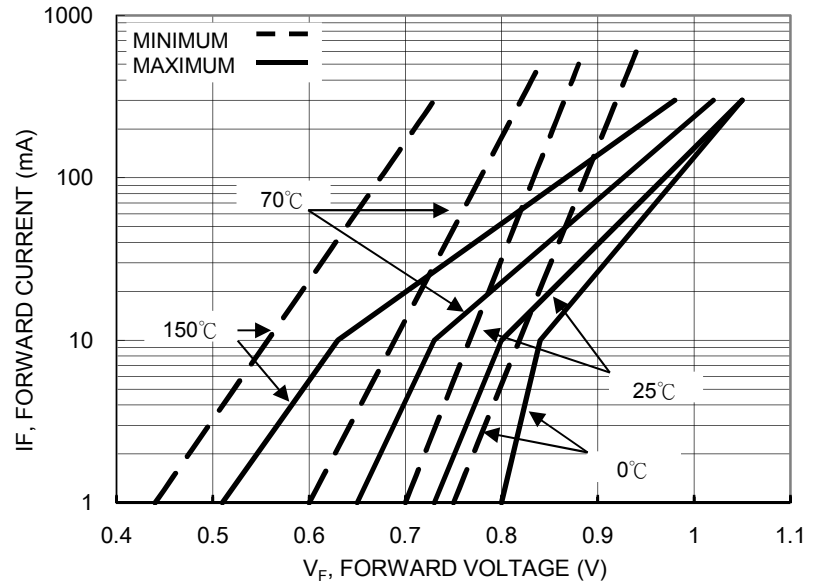

FIG.3 EFFECT OF ZENER CURRENT ON ZENER IMPEDANCE

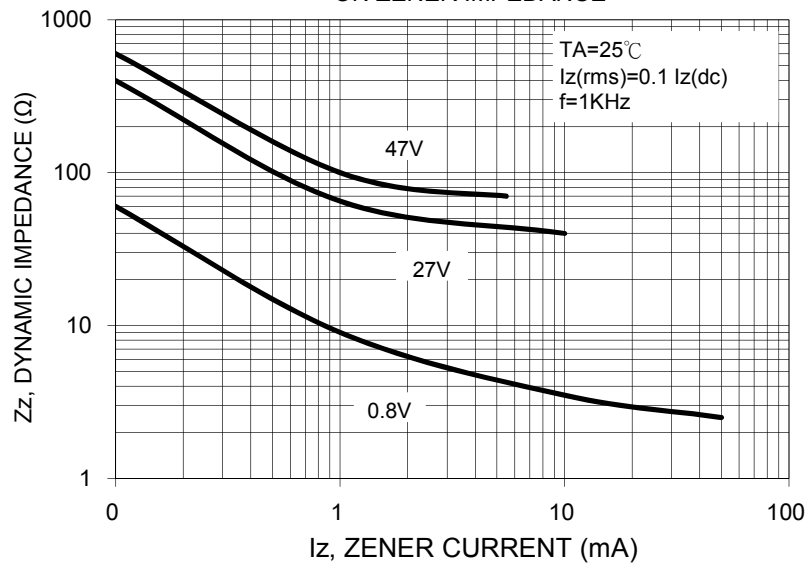

FIG.5 TYPICAL LEAKAGE CURRENT

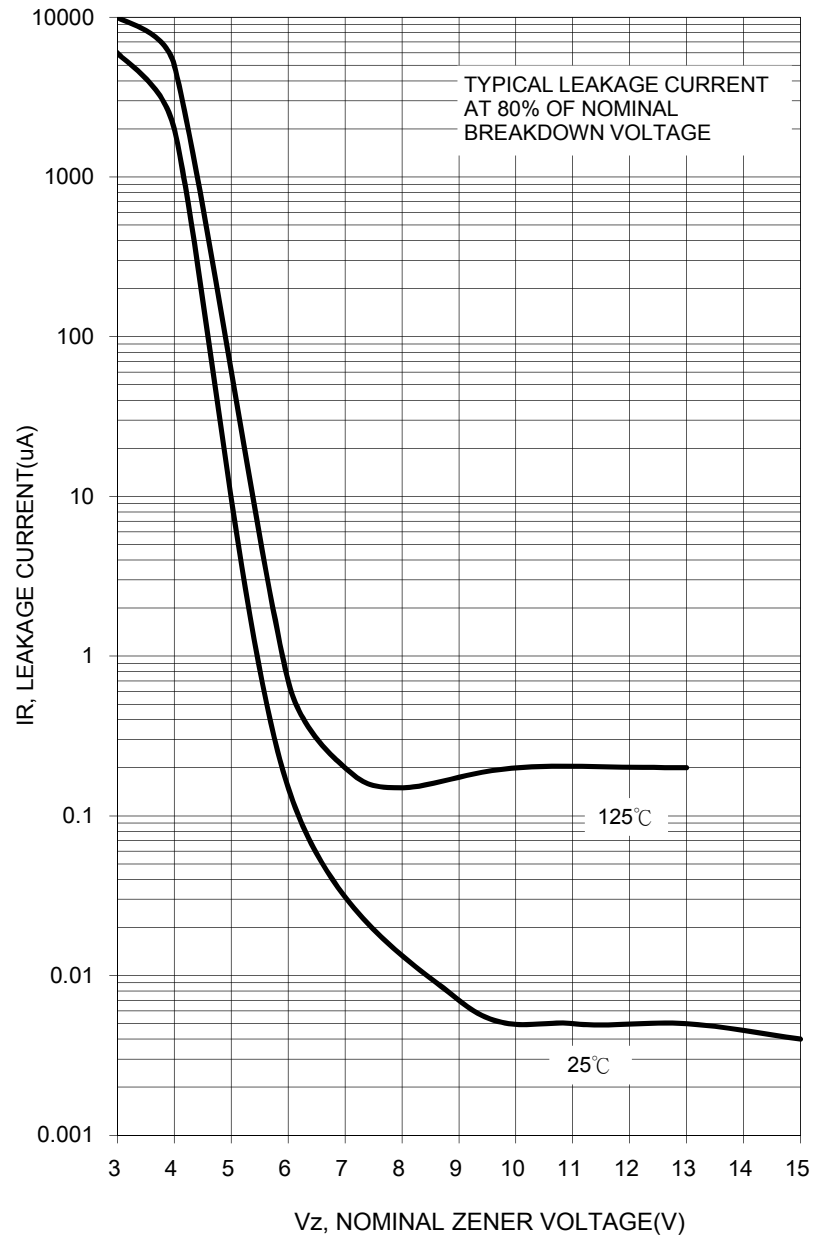
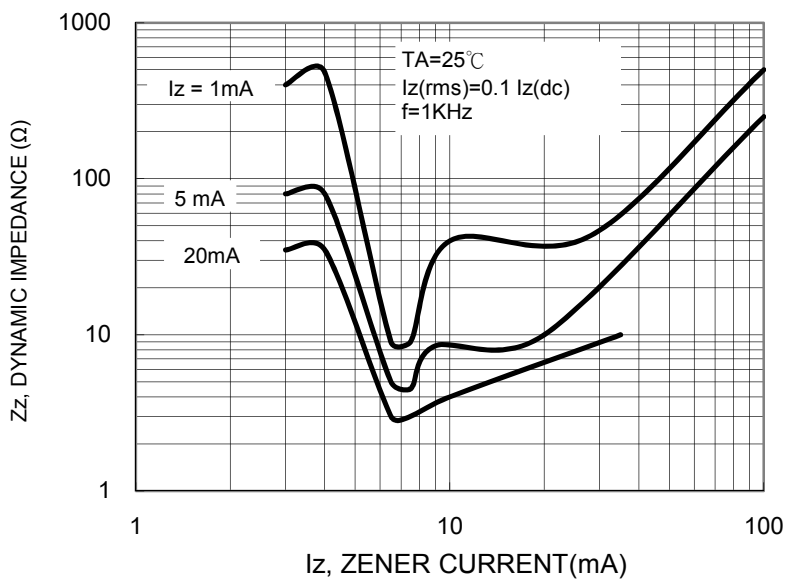

FIG.4 EFFECT OF ZENER VOLTAGE ON ZENER IMPEDANCE



RATINGS AND CHARACTERISTIC CURVES (1SMA4737 THRU 1SMA200Z)

FIG.6 TYPICAL CAPACITANCE versus Vz

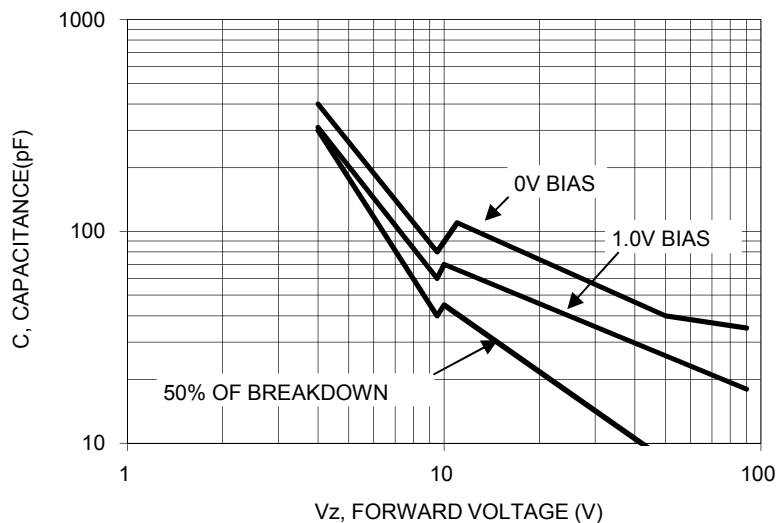

FIG. 7 TEMPERATURE COEFFICIENTS

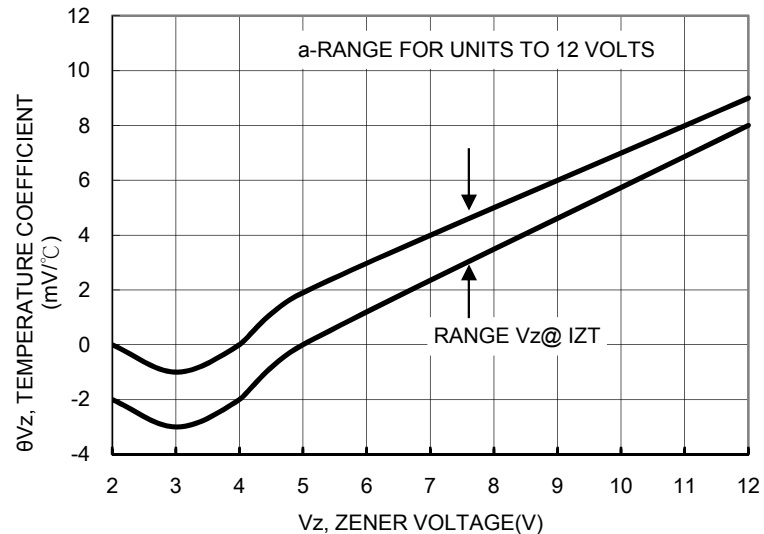

FIG.8 TEMPERATURE COEFFICIENTS

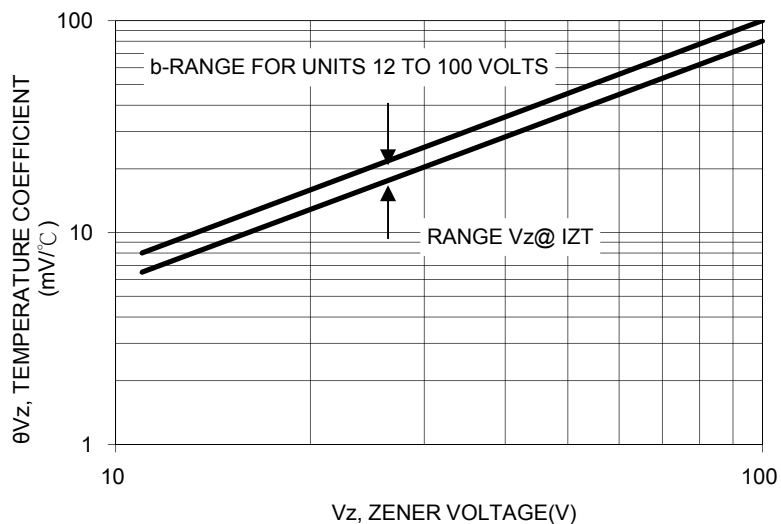

FIG. 9 EFFECT OF ZENER CURRENT

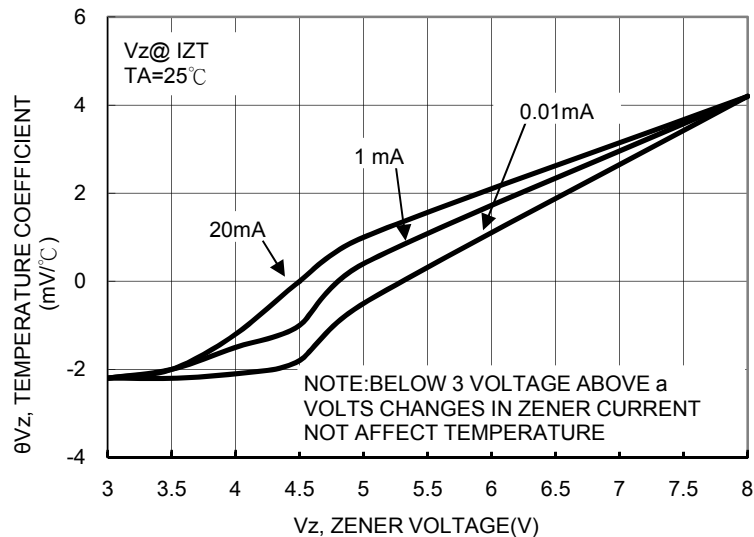
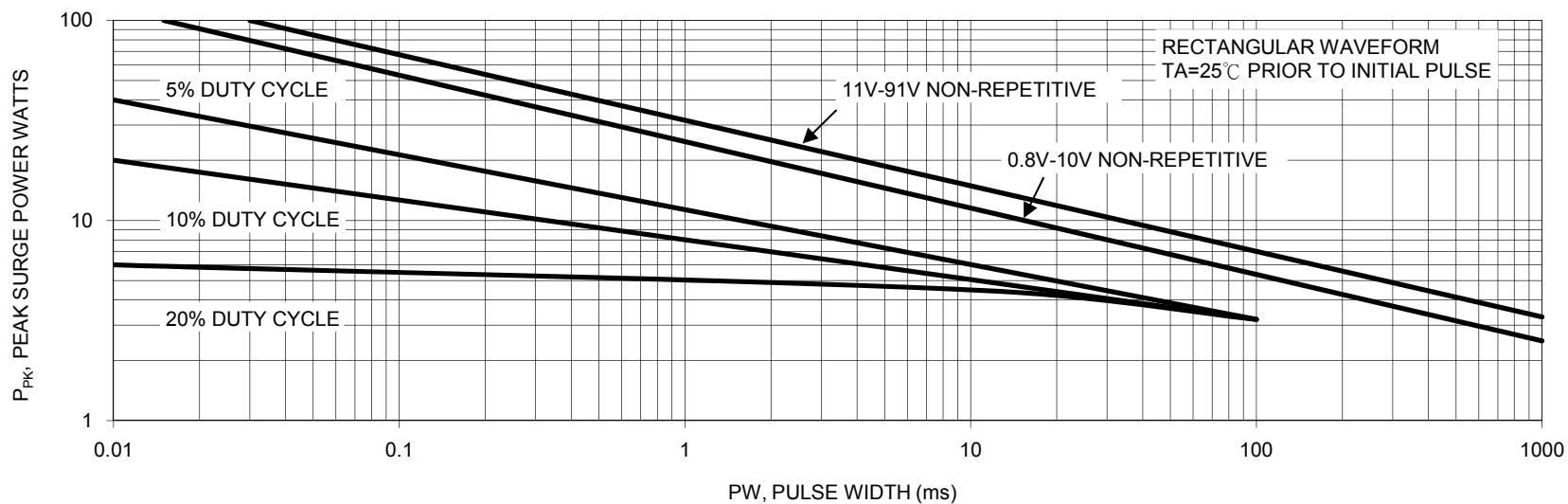

FIG.10 MAXIMUM SURGE POWER



**Ordering information**

Part No.	Package	Packing	Packing code	Packing code (Green)
1SMA"xxxx" (Note)	SMA	1.8K / 7" REEL	R3	R3G
	SMA	7.5K / 13" REEL	R2	R2G
	SMA	7.5K / 13" Plastic REEL	M2	M2G
	Folded SMA	1.8K / 7" REEL	F3	F3G
	Folded SMA	7.5K / 13" REEL	F2	F2G
	Folded SMA	7.5K / 13" Plastic REEL	F4	F4G
	C SMA	1.8K / 7" REEL	E3	E3G
	C SMA	7.5K / 13" REEL	E2	E2G

Note: "x" is Device Code from "4737" thru "200Z".

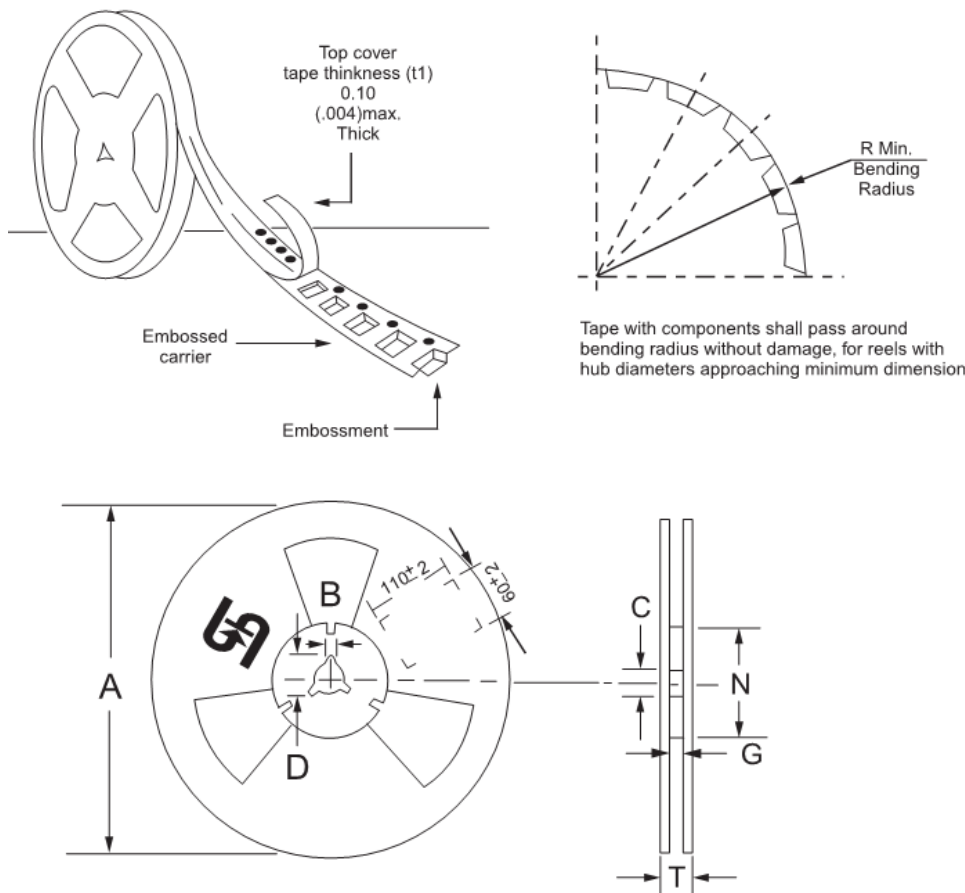
**Tape & Reel specification**

Reel Size	Tape Size	A	B	C	D	N	G	T
		±2.0	±0.4	+0.5;-0.2	min	±1.0	+0.8;-0	max
7"	12mm	178	1.9	13	21	62	12.2	14.6
Reel Size	Tape Size	A	B	C	D	N	G	T
		max	±0.5	±0.5	min	±0.5	+2.0;-0	max
13"	12mm	330	2	13	20.2	75	12.4	18.4

Unit (mm)

### Suggested PAD Layout

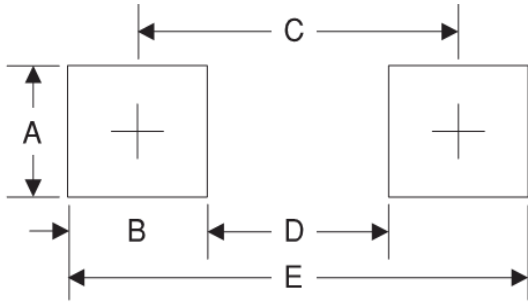

Symbol	Unit(mm)
A	1.78
B	1.51
C	3.92
D	2.41
E	4.43

### Package Outline Dimensions

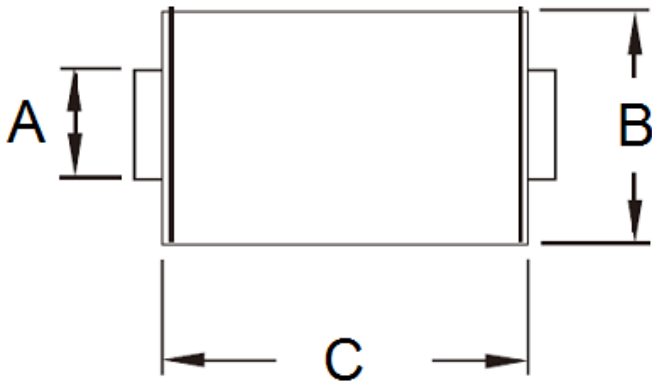

DIM.	Unit(mm)		Unit(inch)	
	Min	Max	Min	Max
A	1.27	1.58	0.050	0.062
B	2.29	2.83	0.090	0.111
C	4.06	4.60	0.160	0.181
D	1.99	2.50	0.078	0.098
E	0.90	1.41	0.035	0.056
F	0.15	0.31	0.006	0.012
G	0.10	0.20	0.004	0.008
H	4.95	5.33	0.195	0.210

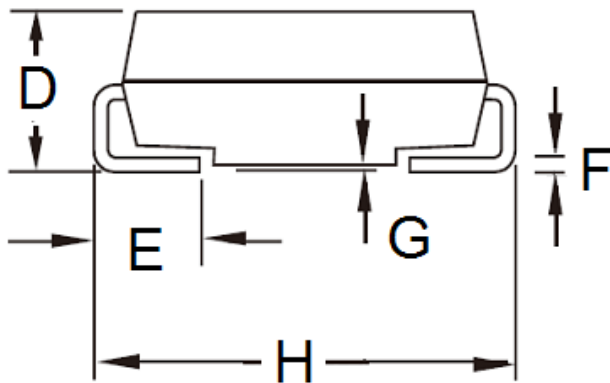

### Marking Diagram

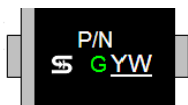

P/N = Specific Device Code  
 G = Green Compound  
 YW = Date Code