

**80mΩ, Current Limited, Power Distribution Switch**

**Descriptions**

The WS4601 is high-side switch with ultra-low ON resistance P-MOSFET. Integrated current-limit function can limit inrush current for heave capacitive load, over load current, and short-circuit current to protect power source.

The WS4601 is also integrated reverse protection function to eliminate any reverse current flow across the switch when the device is off. Output auto-discharge while the device shutdown made output voltage off quickly. Thermal shutdown function can protect the device and load.

The WS4601 is available in SOT-23-5L package. Standard product is Pb-free and Halogen-free.

**Features**

- Input voltage range : 2.5~5.5
- Main switch  $R_{ON}$  : 80mΩ @  $V_{IN}=5V$
- Continue output current : 1.0A
- Current limit threshold : 1.5A (Typ.)
- Current limit accurate : +/-20%
- Output short current : 0.7A (Typ.)
- Auto discharge
- Reverse block (No “body diode”)
- Over temperature protection

**Applications**

- USB peripherals
- USB Dongle
- USB 3G data card
- 3.3V or 5V Power Switch
- 3.3V or 5V Power Distribution



SOT-23-5L

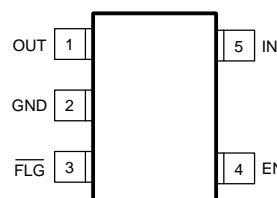

Pin configuration (Top view)

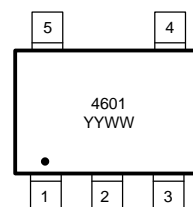

**4601** = Device code  
**YY** = Year code  
**WW** = Week code  
**Marking**

**Order information**

Device	Package	Shipping
WS4601E-5/TR	SOT-23-5L	3000/Reel&Tape

### Typical Applications

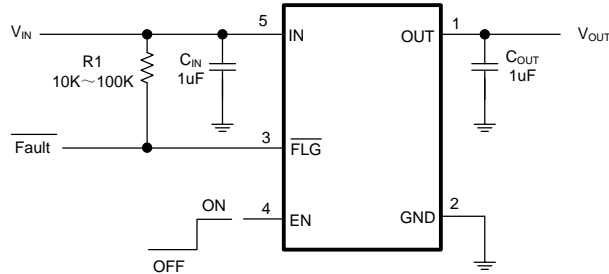

### Pin Descriptions

Pin Number	Symbol	Descriptions
1	OUT	Output Pin
2	GND	Ground
3	FLG	Fault Flag Pin, Open-Drain, Active Low
4	EN	Enable Pin, Active High
5	IN	Input Pin

### Block Diagram

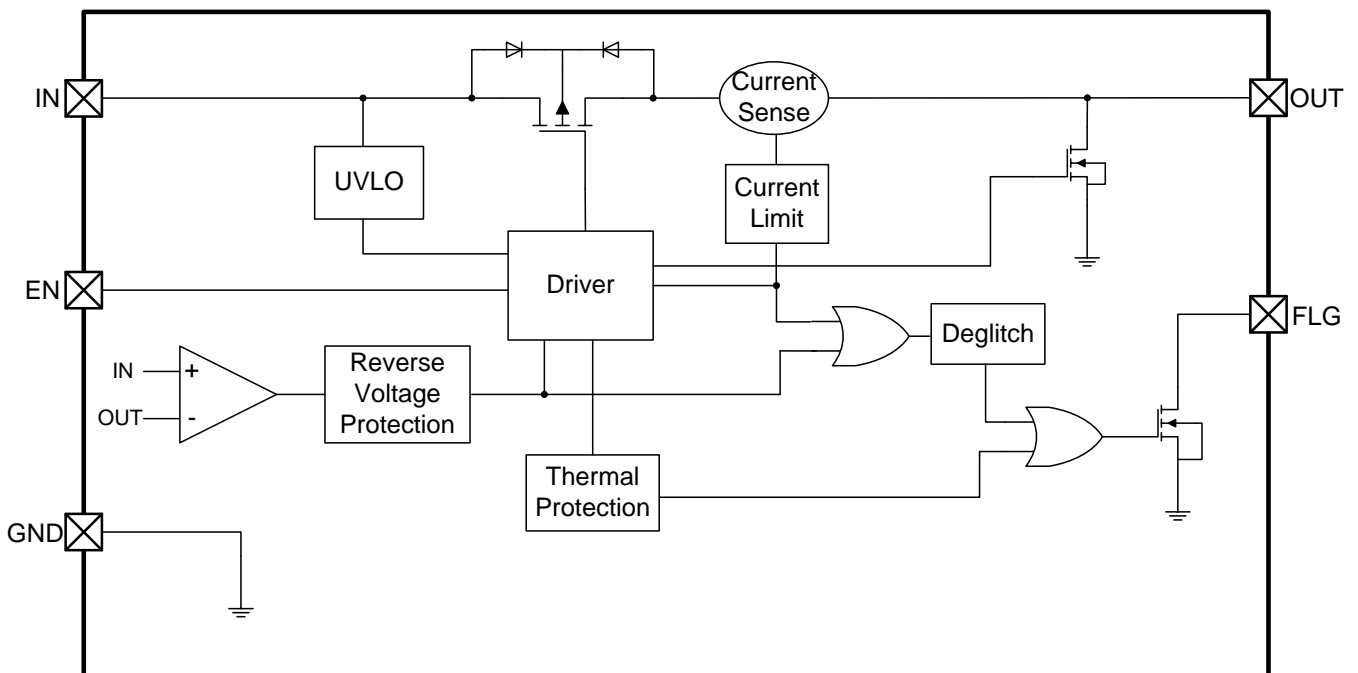

### Absolute maximum ratings

Parameter	Symbol	Value	Unit
IN pin voltage range	$V_{IN}$	-0.3~6.5	V
OUT pin voltage range	$V_{OUT}$	-0.3~6.5	V
FLG pin voltage range	$V_{FLG}$	-0.3~6.5	V
EN pin voltage range	$V_{EN}$	-0.3~6.5	V
Junction temperature	$T_J$	-40~150	°C
Lead temperature(Soldering, 10s)	$T_L$	260	°C
Storage temperature	Tstg	-55 ~ 150	°C
IN, OUT Pin ESD Ratings	HBM	8000	V
	MM	400	V
FLG, EN Pin ESD Ratings	HBM	4000	V
	MM	400	V

These are stress ratings only. Stresses exceeding the range specified under “Absolute Maximum Ratings” may cause substantial damage to the device. Functional operation of this device at other conditions beyond those listed in the specification is not implied and prolonged exposure to extreme conditions may affect device reliability.

### Recommend Operating Conditions

Parameter	Symbol	Value	Unit
Supply input voltage range	$V_{IN}$	2.5~5.5	V
Operating ambient temperature	$T_A$	-40~85	°C
Thermal Resistance	$R_{\theta JA}$	250	°C/W

**Electronics Characteristics (Ta=25°C, V<sub>IN</sub>=5V, C<sub>IN</sub>=C<sub>OUT</sub>=1uF, unless otherwise noted)**

Parameter	Symbol	Conditions	Min.	Typ.	Max.	Units
Quiescent supply current	I <sub>Q</sub>	I <sub>OUT</sub> =0, V <sub>IN</sub> =V <sub>EN</sub> =5V		48	60	uA
Shutdown current	I <sub>SD</sub>	V <sub>EN</sub> =0V			1	uA
Reverse current	I <sub>REV</sub>	V <sub>IN</sub> =V <sub>EN</sub> =0V, V <sub>OUT</sub> =5V, Current flow to V <sub>IN</sub>			1	uA
Main-FET ON resistance <sup>(1)</sup>	R <sub>ON</sub>	V <sub>IN</sub> =V <sub>EN</sub> =5V, I <sub>OUT</sub> =500mA		80		mΩ
Auto-discharge FET ON resistance	R <sub>DCHG</sub>	V <sub>EN</sub> =0V, V <sub>IN</sub> =V <sub>OUT</sub> =5V		65		Ω
Over-current trip threshold	I <sub>OC</sub>	Current ramp (≤100A/s) on OUT	1.2	1.5	1.8	A
Short-circuit output current	I <sub>OS</sub>	OUT shorted to GND		0.7		A
Short circuit current limiting response time	t <sub>SHORT</sub>	OUT connected to GND, C <sub>L</sub> =1uF		3		us
EN input low voltage	V <sub>IL</sub>	V <sub>IN</sub> =5V			0.4	V
EN input high voltage	V <sub>IH</sub>	V <sub>IN</sub> =5V	2.0			V
OUT pin turn-on time after EN ON	t <sub>ON</sub>	C <sub>L</sub> =1uF, R <sub>L</sub> =5ohm		20		us
Fault flag output blanking time	t <sub>BLANK</sub>			8		ms
Over-temperature shutdown threshold	T <sub>SD</sub>			160		°C
Over-temperature threshold hysteresis	T <sub>HYS</sub>			35		°C
Under voltage lock out threshold	V <sub>UVLO</sub>			2.2		V
Under voltage lock out hysteresis	V <sub>UVLO-HYS</sub>			200		mV

(1) Pulse test, T<sub>p</sub>=380us

Typical Characteristics (Ta=25°C, unless otherwise noted)

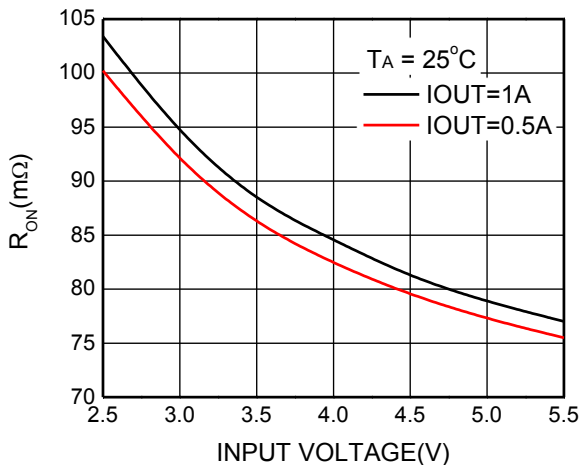

ON Resistance vs. Input Voltage

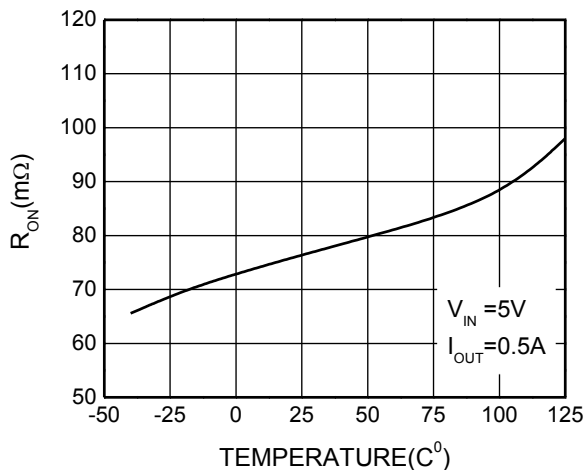

ON Resistance vs. Temperature

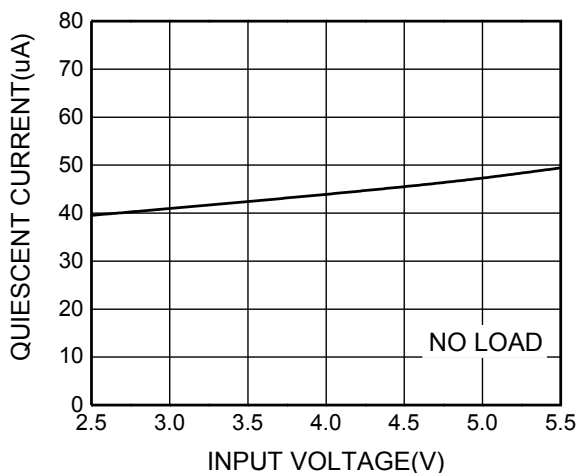

Quiescent current vs. Input Voltage

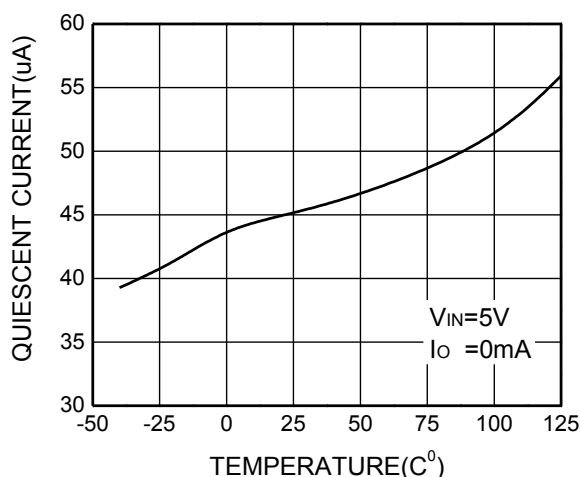

Quiescent current vs. Temperature

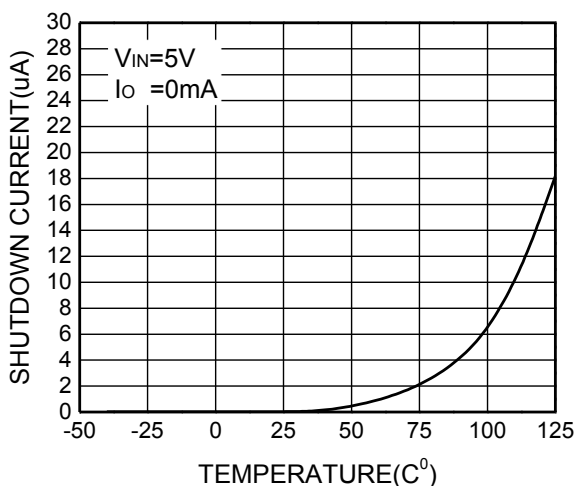

Shut-down Current vs. Temperature

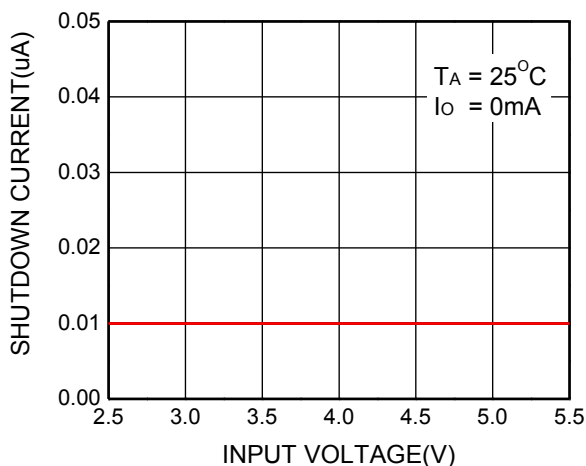

Shut-down Current vs. Input Voltage

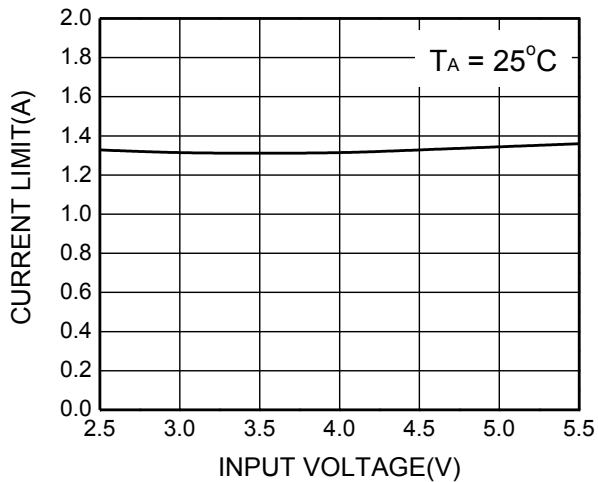

Current Limit vs. Input Voltage

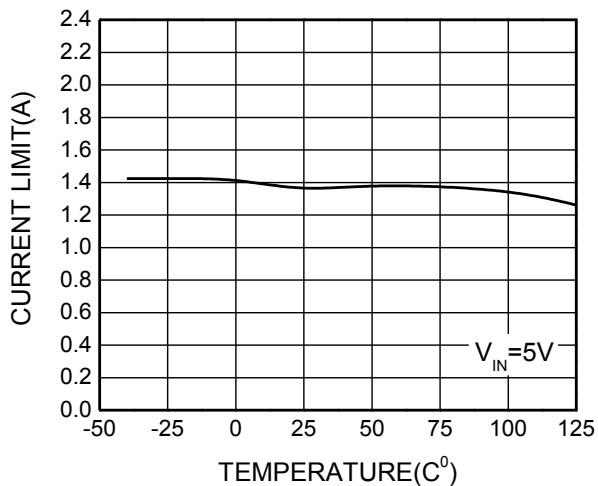

Current Limit vs. Temperature

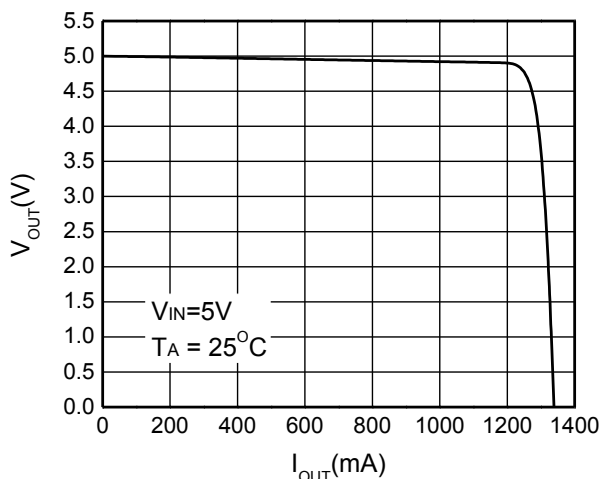

Output Voltage vs. Output Current

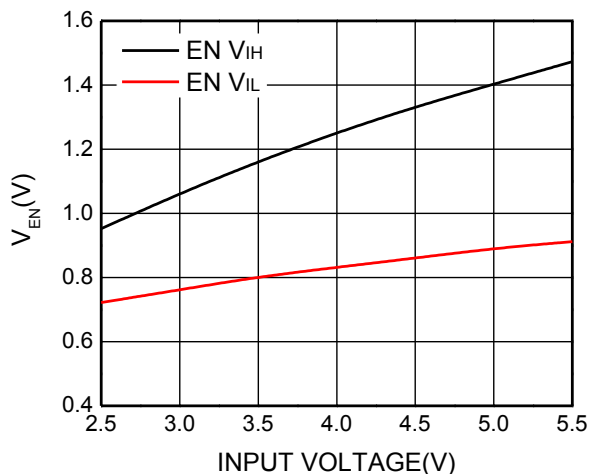

EN Threshold vs. Input Voltage

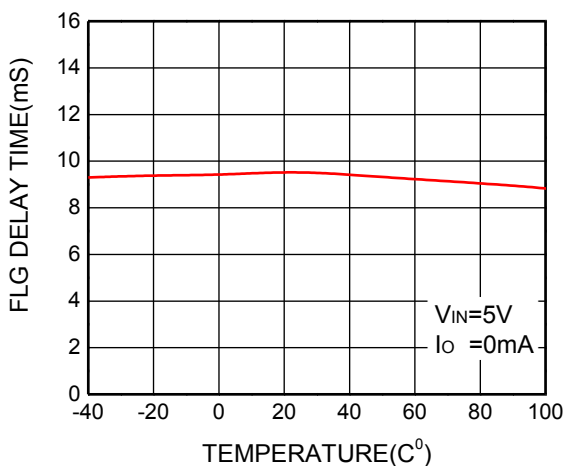

Fault Flag Blanking time vs. Temperature

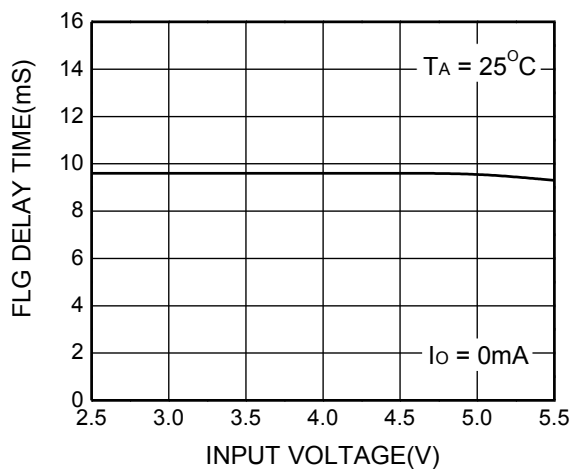

Fault Flag Blanking time vs. Temperature

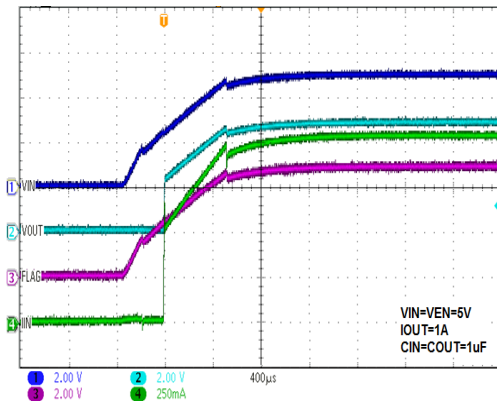

Startup from Power ON

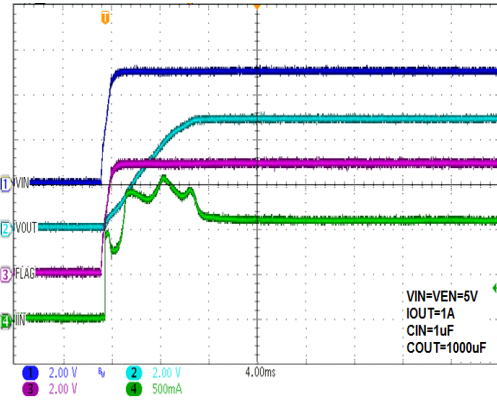

Startup from Power ON

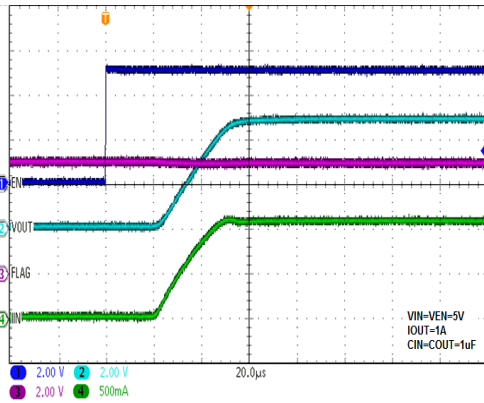

Startup from Enable ON

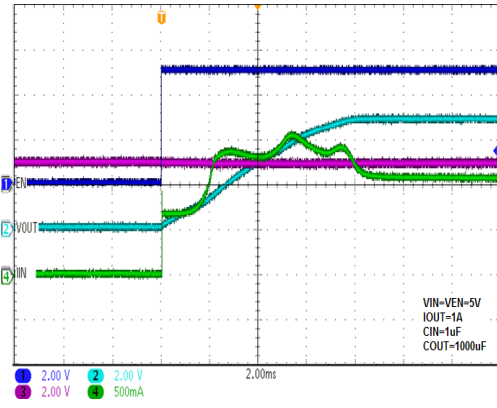

Startup from Enable ON

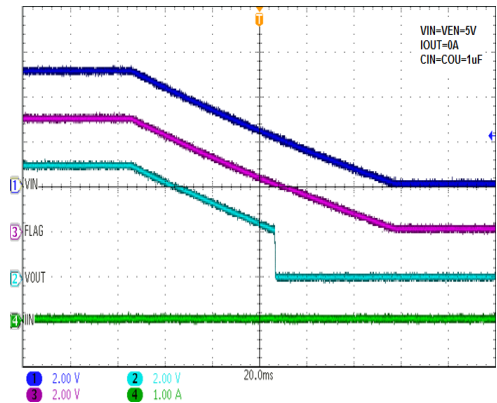

Shutdown from Power OFF

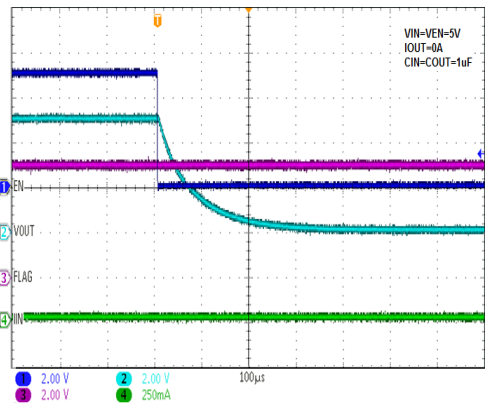

Shutdown from Enable OFF

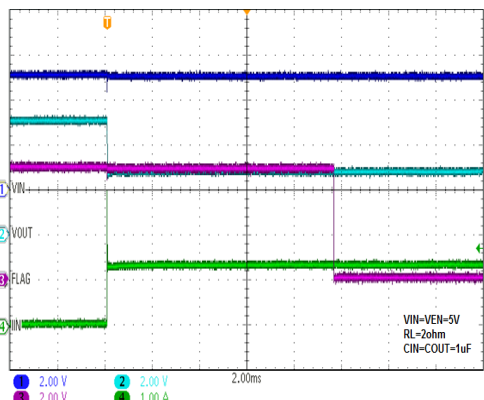

Current Limit Response

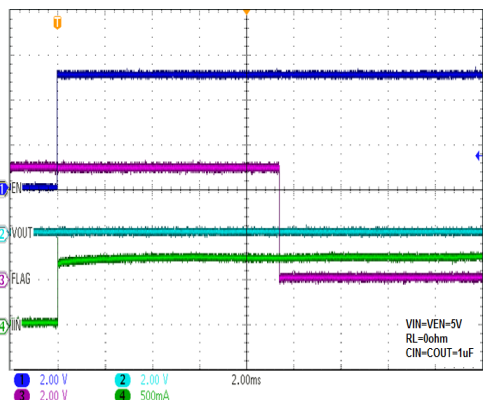

Short Circuit Response

## Operation Information

### Power Switch

The power switch is an P-channel MOSFET with low  $R_{DS(ON)}$  for power management or USB power distribution applications. The WS4601 has reverse voltage protection to prevents current flow from OUT to IN and IN to OUT when device is off.

### Current-Limit Protection

The WS4601 provide current limit protection function to protect power source when over-current condition occurs.

### Short-Circuit Protection

The WS4601 provide short circuit protection function. The output current will be limited to safe level. The short-circuit protection is used to reduce power dissipation of the device and protect power source during short-circuit condition.

### Fault indicate

The  $\overline{FLG}$  open drain output is asserted (active low) with 8ms(Typ.) delay when an over-current or over-temperature condition is encountered. The  $\overline{FLG}$  signal will remain asserted until the over-current or over-temperature condition is removed.

### UVLO Protection

To avoid malfunction of the WS4601 at low input voltages, an under voltage lockout is included that disables the device, until the input voltage exceeds 2.2V (Typ.).

### Shutdown Mode

Drive EN to GND to place the WS4601 in shutdown mode. In shutdown mode, input current falls to smaller than 1uA.

### Thermal Shutdown

As soon as the junction temperature ( $T_J$ ) exceeds 160°C (Typ.), the WS4601 goes into thermal shutdown. In this mode, the device is turned off and will turn on again until Junction temperature falls below 125°C (Typ.).



## Application Information

### Input Capacitor

A 1 $\mu$ F input bypass ceramic capacitor( $C_{IN}$ ) from IN to GND, located near the WS4601 is strongly recommended to suppress the voltage overshooting during short circuit fault event. Without the bypass capacitor, the output short may cause sufficient ringing on the input (from supply lead inductance) to damage the device.

### Output Capacitor

A low ESR, 150 $\mu$ F aluminum electrolytic or tantalum between OUT and GND is strongly recommended to reduce the voltage droop during hot-plug of downstream peripheral. Higher value output capacitor is better when the output load is heavy. Additionally, bypassing the output with a 1 $\mu$ F ceramic capacitor improves the immunity of the device to short-circuit transients.

### PCB Layout consideration

The PCB layout should be carefully performed to maximize thermal dissipation and to minimize voltage drop. The following guidelines must be considered:

1. Please place the input capacitors near the IN pin as close as possible.
2. Output decoupling capacitors for load must be placed near the load as close as possible for decoupling high frequency ripples.
3. Locate WS4601 and output capacitors near the load to reduce parasitic resistance and inductance for excellent load transient performance.
4. The negative pins of the input and output capacitors and the GND pin must be connected to the ground plane of the load.
5. Keep IN and OUT traces as wide and short as possible.

Package outline dimensions

SOT-23-5L

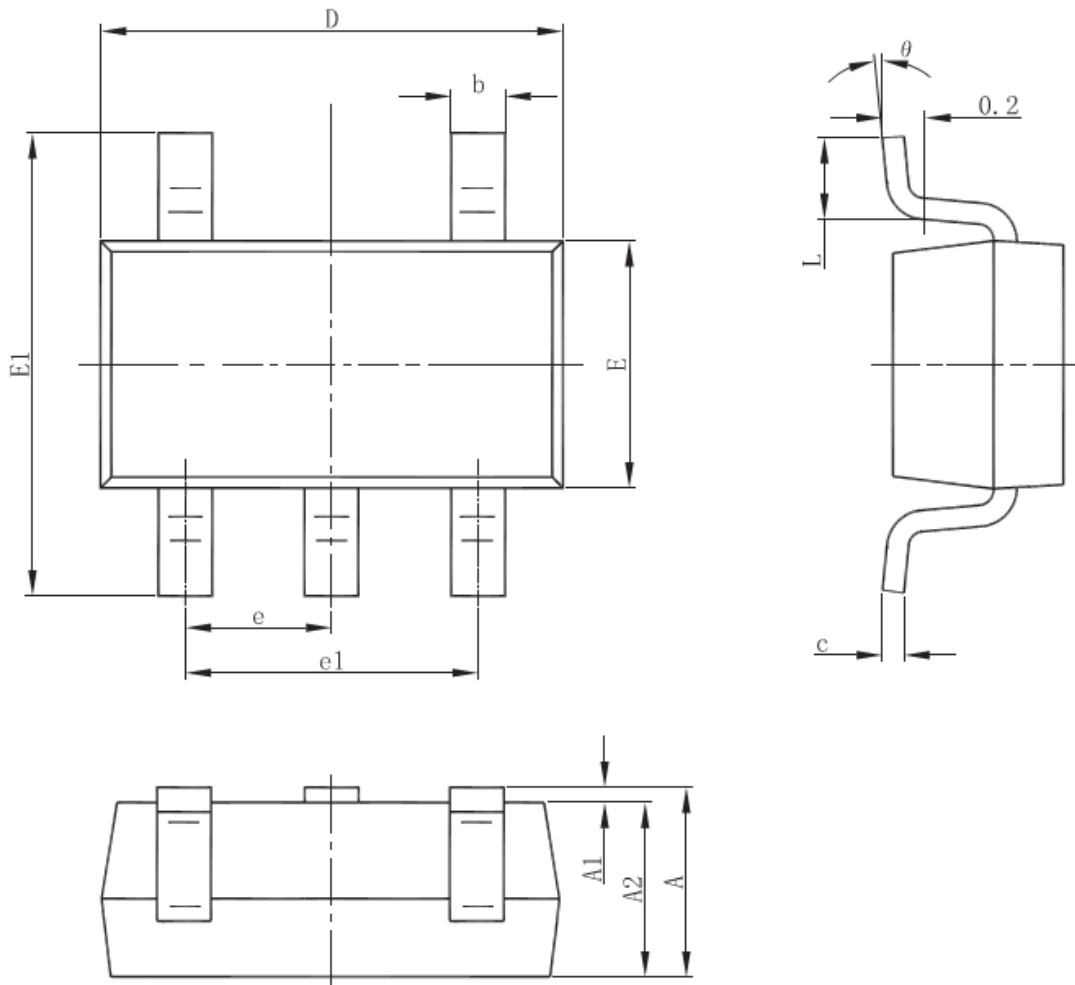

Symbol	Dimensions in millimeter		
	Min.	Typ.	Max.
A	1.050	-	1.250
A1	0.000	-	0.100
A2	1.050	-	1.150
b	0.300	-	0.500
c	0.100	-	0.200
D	2.820	2.900	3.020
E	1.500	1.600	1.700
E1	2.650	2.800	2.950
e	0.950(BSC)		
e1	1.800	-	2.000
L	0.300	-	0.600
θ	0°	-	8°