

8 - 15 GHz Packaged Doubler with Amplifier

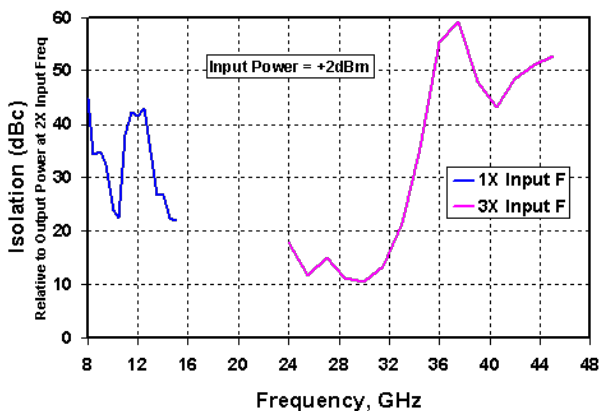

Measured Performance

Bias conditions: $V_d = 5\text{ V}$, $I_d = 150\text{ mA}$, $V_{dbl} = -0.8\text{ V}$,
 $V_g = -0.5\text{ V}$ Typical

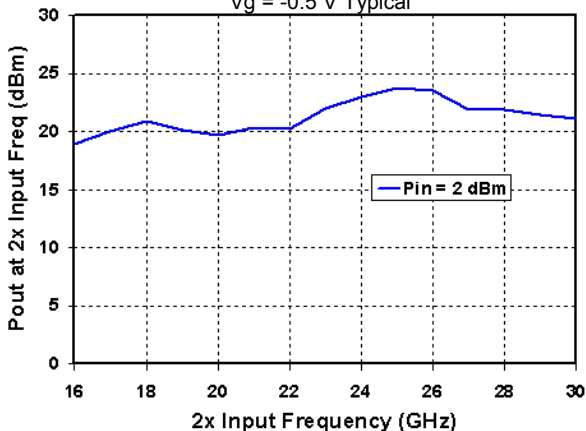

Key Features

- RF Output Frequency Range: 16-30 GHz
- Input Frequency Range: 8 - 15 GHz
- 20 dBm Nominal Pout
- 18 dB Gain
- 30 dBc Input Frequency Isolation
- Bias: $V_d = 5\text{ V}$, $I_d = 150\text{ mA}$, $V_{dbl} = -0.8\text{ V}$, $V_g = -0.5\text{ V}$ Typical
- Package Dimensions: 4 x 4 x 0.9 mm

Primary Applications

- Point-to-Point Radio
- Ka Band Sat-Com

Product Description

The TriQuint TGC4403-SM packaged MMIC combines a frequency doubler with a 3-stage amplifier, operating at input frequencies of 8 - 15 GHz. With greater than 30 dBc isolation between the input and doubled frequency, the TGC4403-SM achieves 20 dBm output power, with 2 dBm input power. This performance makes this doubler ideally suited for Point to Point Radios and Ka-Band satellite ground terminal applications. The TGC4403-SM provides the frequency doubling function in an compact 4 mm x 4 mm package footprint.

Each device is 100% DC and RF tested on-wafer to ensure performance compliance. The device is available in chip form.

The TGC4403-SM has a protective surface passivation layer on the MMIC providing environmental robustness.

Lead-free and RoHS compliant.

Datasheet subject to change without notice.

Table I
Absolute Maximum Ratings 1/

Symbol	Parameter	Value	Notes
Vd-Vg	Drain to Gate Voltage	12 V	
Vd	Drain Voltage	8 V	2/
Vdbl	Doubler Voltage Range	-5 to 0 V	
Vg	Gate Voltage Range	-5 to 0 V	
Id	Positive Current	280 mA	2/
Ig	Gate Current Range	-1 to 23 mA	
Idbl	Doubler Current Range	-0.6 to 16.8 mA	
Pin	Input Continuous Wave Power	18.2 dBm	2/

- 1/ These ratings represent the maximum operable values for this device. Stresses beyond those listed under "Absolute Maximum Ratings" may cause permanent damage to the device and / or affect device lifetime. These are stress ratings only, and functional operation of the device at these conditions is not implied.
- 2/ Combinations of supply voltage, supply current, input power, and output power shall not exceed the maximum power dissipation listed in Table IV.

Table II
Recommended Operating Conditions

Symbol	Parameter 1/	Value
Vd	Drain Voltage	5 V
Id	Drain Current (quiescent)	150 mA
Id_drive	Drain Current with RF input = 2 dBm	170 mA
Vg	Gate Voltage	-0.5 V
Vdbl	Doubler Voltage	-0.8 V

- 1/ See assembly diagram for bias instructions.

Table III
RF Characterization Table

Bias: Vd = 5 V, Id = 150 mA, Vg = -0.5 V typical, Vdbl = -0.8 V fixed

SYMBOL	PARAMETER	TEST CONDITIONS	MIN	NOMINAL	MAX	UNITS
RF_Freq	Input Frequency Range			8 - 15		GHz
CGain	Conversion Gain (RFin = 2 dBm)	Freq_in= 8 – 14.5 GHz Freq_out = 16 - 29 GHz Freq_in= 15 GHz Freq_out = 30 GHz	14 12	18 16		dB
IRL	Input Return Loss	Freq = 8 - 15 GHz		6		dB
ORL	Output Return Loss	Freq = 16 - 30 GHz		4		dB
Pout	Output Power (RFin = 2 dBm)	Freq = 16 - 30 GHz	16	20		dBm
Isol_1x	Isolation, Fundamental	Freq_in= 8 – 14.5 GHz Freq_out = 8 – 14.5 GHz	11	30		dBc
Isol_3x	Isolation, 3 rd Harmonic	Freq_in= 8 – 10.5 GHz Freq_out = 24–31.5 GHz	1	10		dBc

Table IV

Power Dissipation and Thermal Properties

Parameter	Test Conditions	Value	Notes
Maximum Power Dissipation	Tbaseplate = 70 °C	Pd = 1.42 W Tchannel = 150 °C Tm = 1.0E+6 Hrs	1/
Thermal Resistance, θ_{jc}	Vd = 5 V Id = 150 mA Pd = 0.75 W	θ_{jc} = 56.3 (°C/W) Tchannel = 112 °C Tm = 3.4E+7 Hrs	
Thermal Resistance, θ_{jc} Under RF Drive	Vd = 5 V Id = 170 mA Pout = 22 dBm Pd = 0.69 W	θ_{jc} = 56.3 (°C/W) Tchannel = 109 °C Tm = 4.6E+7 Hrs	
Mounting Temperature	30 Seconds	320 °C	
Storage Temperature		-65 to 150 °C	

1/ Channel operating temperature will directly affect the device median lifetime (Tm). For maximum life, it is recommended that channel temperatures be maintained at the lowest possible levels.

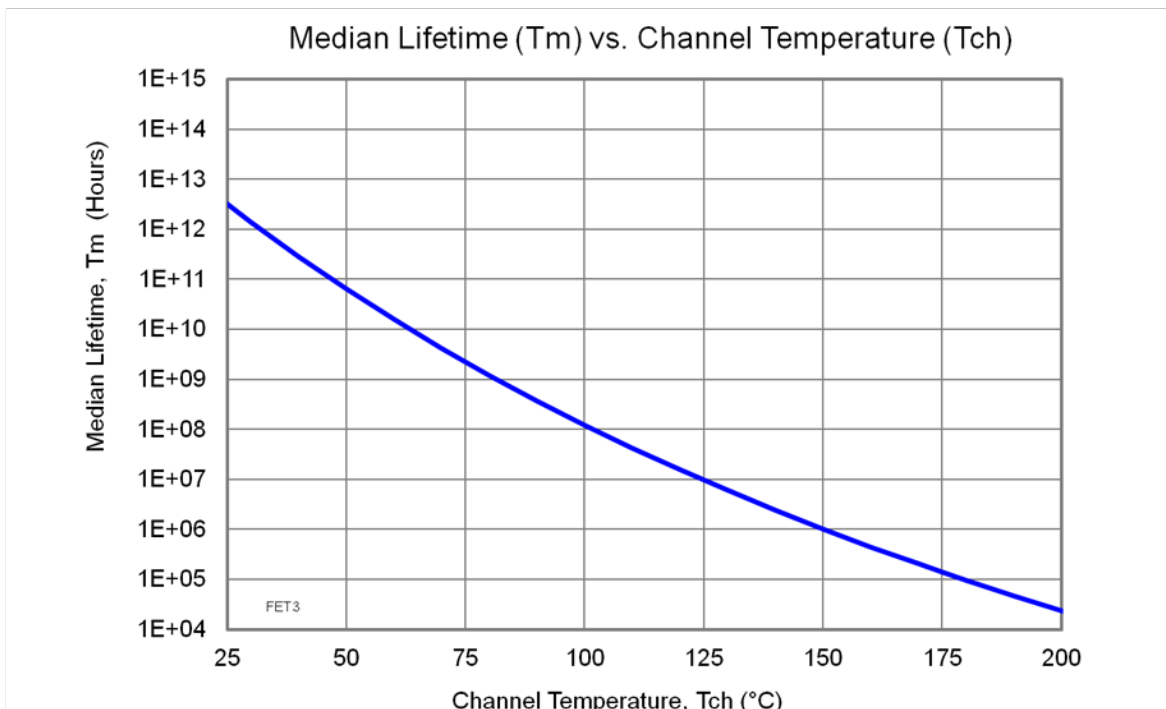

Measured Data

Bias conditions: $V_d = 5\text{ V}$, $I_d = 150\text{ mA}$, $V_g = -0.5\text{ V}$, $V_{dbl} = -0.8\text{ V}$ Typical

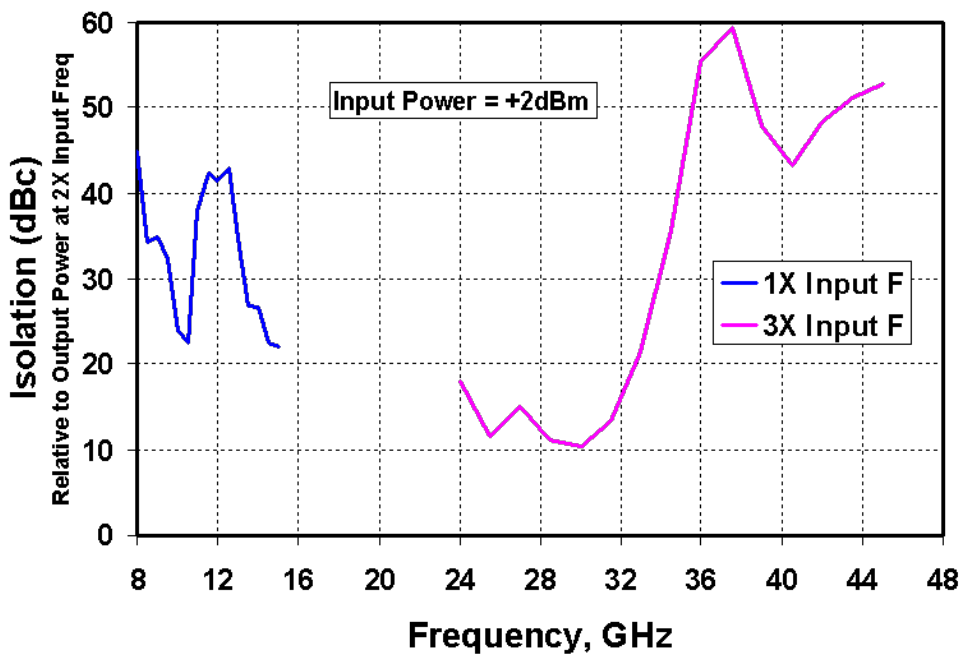
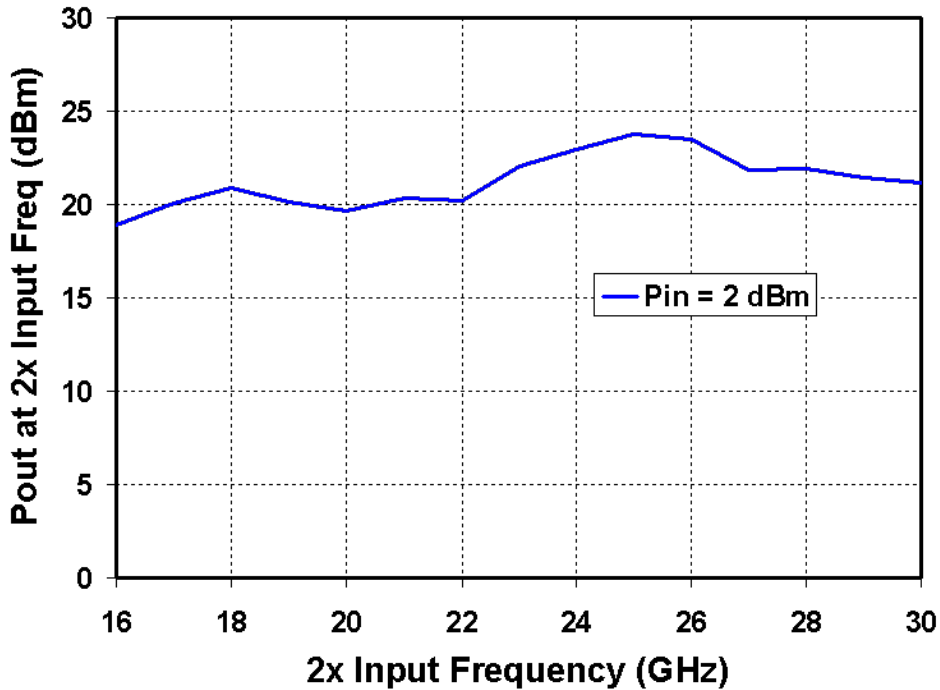

Measured Data

Bias conditions: $V_d = 5\text{ V}$, $I_d = 150\text{ mA}$, $V_g = -0.5\text{ V}$, $V_{dbl} = -0.8\text{ V}$ Typical

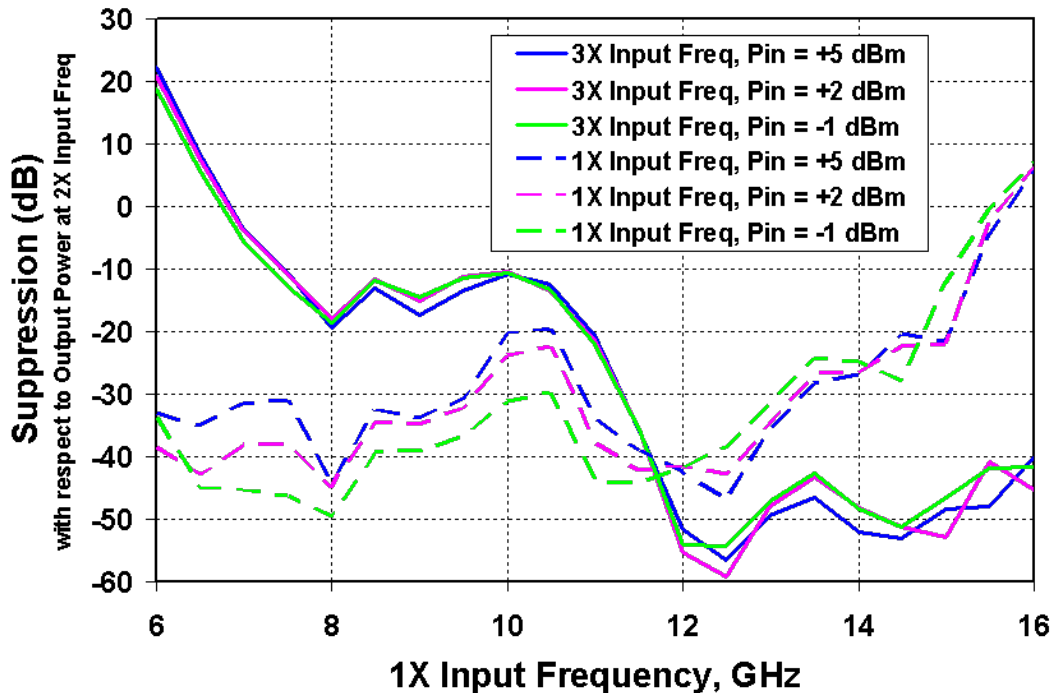
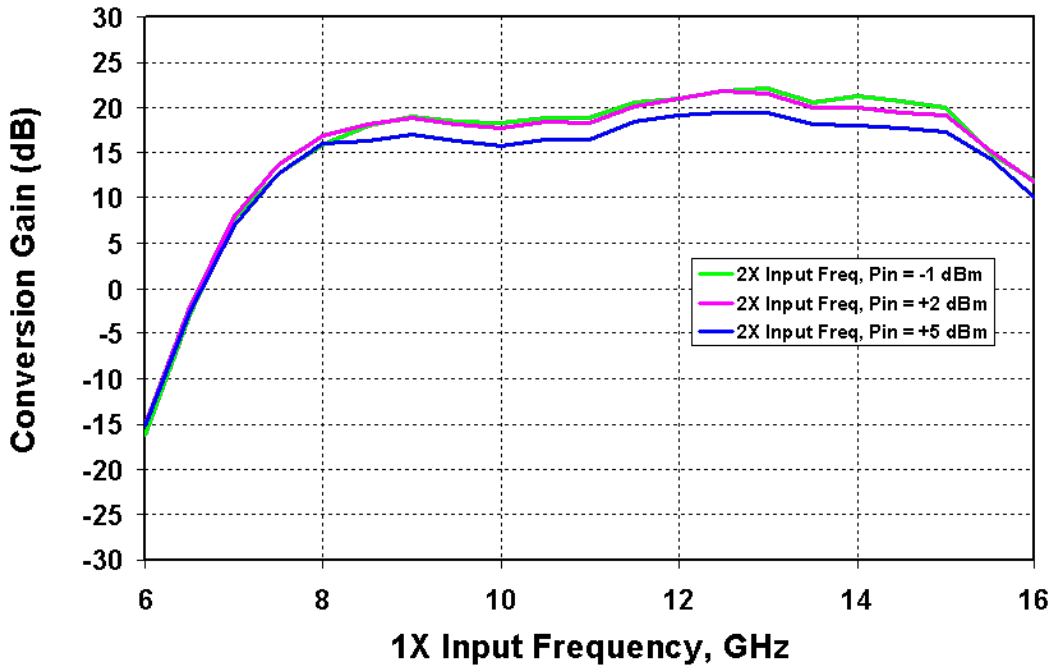

Measured Data

Bias conditions: $V_d = 5\text{ V}$, $I_d = 150\text{ mA}$, $V_g = -0.5\text{ V}$, $V_{dbl} = -0.8\text{ V}$ Typical

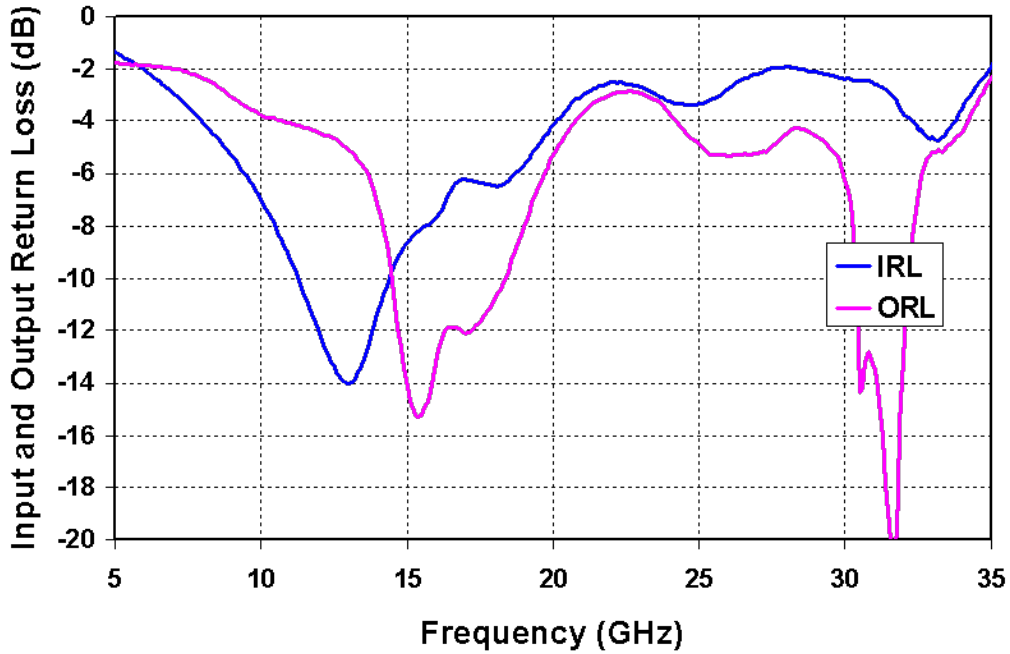

Package Pinout

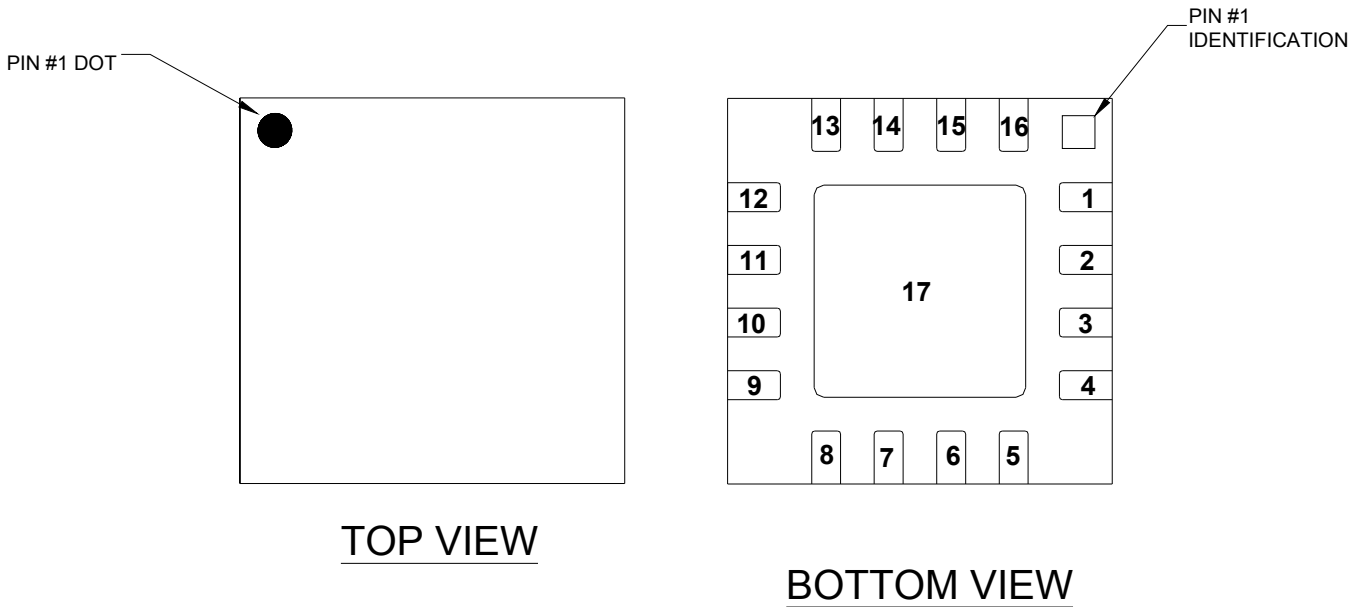

Pin	Description
1, 2, 4, 7, 8, 9, 11, 12, 13, 15, 16	N/C
3	RF Input
5	Vdbl
6	Vg
10	RF Out
14	Vd
17	GND

Electrical Schematic

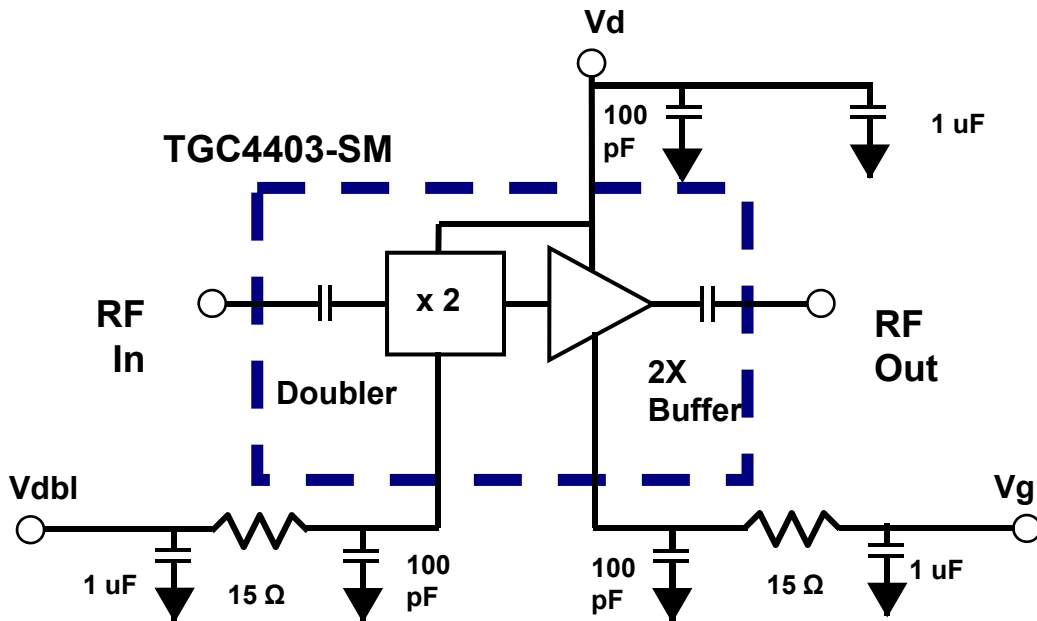

Bias Procedures

Bias-up Procedure

- Vg set to -1.5 V
- Vd set to +5 V
- Vdbl set to -0.8 V
- Adjust Vg more positive until Id is 150 mA. This will be ~ Vg = -0.5 V
- Apply signal to input, Id will increase

Bias-down Procedure

- Turn off signal
- Reduce Vg to -1.5V. Ensure Id ~ 0 mA
- Turn Vdbl to 0V
- Turn Vd to 0V
- Turn Vg to 0V

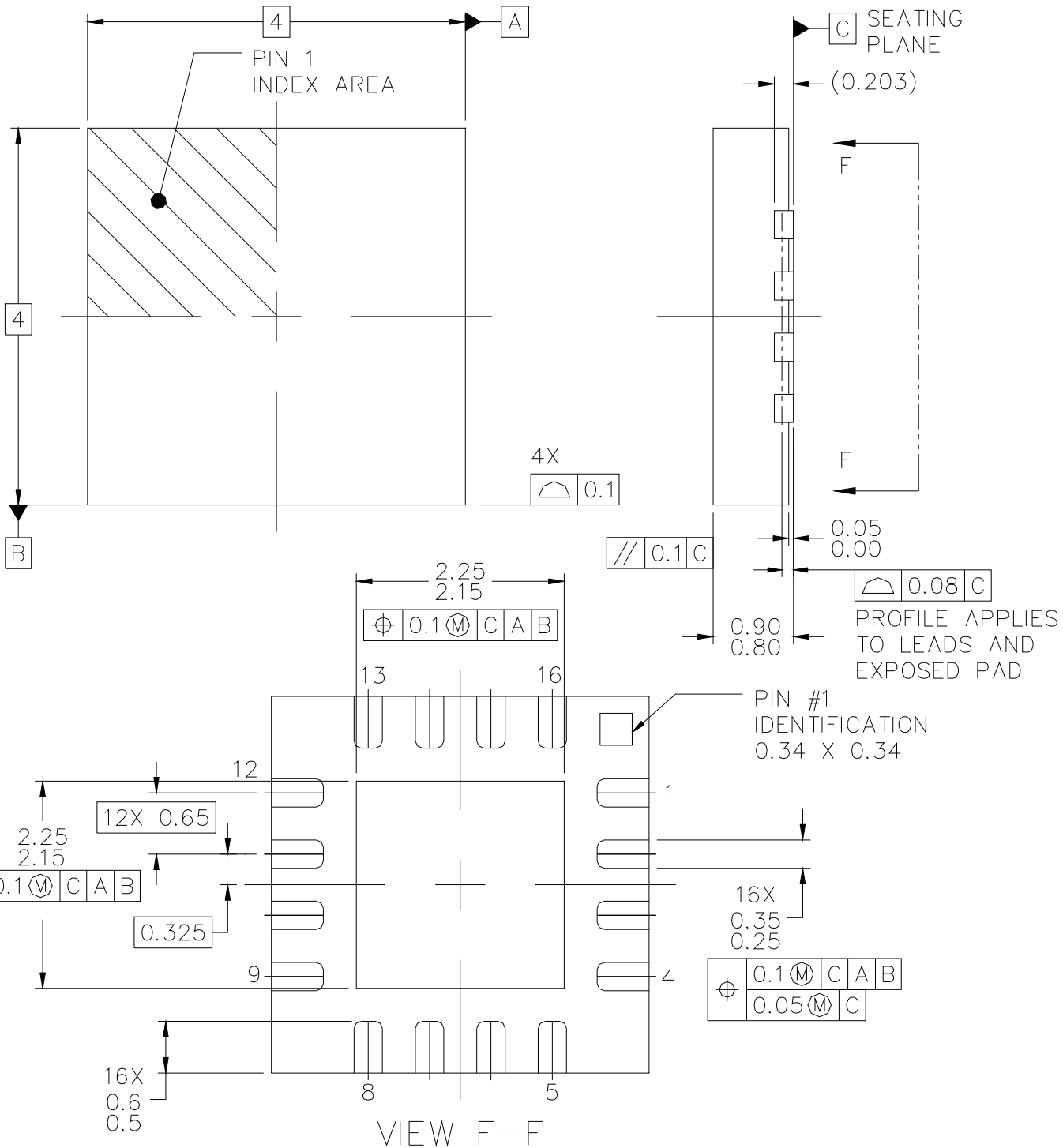

GaAs MMIC devices are susceptible to damage from Electrostatic Discharge. Proper precautions should be observed during handling, assembly and test.

Recommended Assembly Diagram

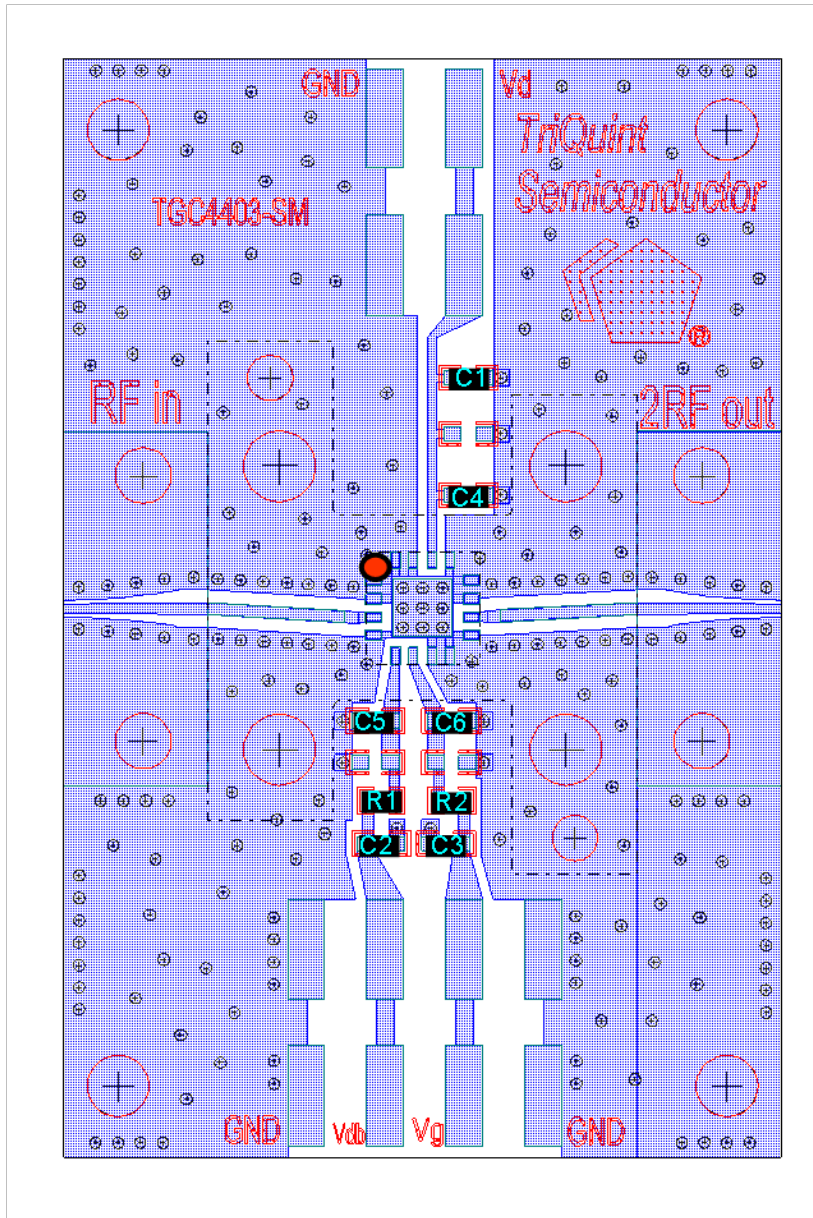

Part	Description
C1,C2,C3	1 uF Capacitor (0402)
C4,C5,C6	100 pF Capacitor (0402)
R1,R2	15 ohm Resistor (0402)

GaAs MMIC devices are susceptible to damage from Electrostatic Discharge. Proper precautions should be observed during handling, assembly and test.

Assembly Notes

Recommended Surface Mount Package Assembly

- Proper ESD precautions must be followed while handling packages.
- Clean the board with acetone. Rinse with alcohol. Allow the circuit to fully dry.
- TriQuint recommends using a conductive solder paste for attachment. Follow solder paste and reflow oven vendors' recommendations when developing a solder reflow profile. Typical solder reflow profiles are listed in the table below.
- Hand soldering is not recommended. Solder paste can be applied using a stencil printer or dot placement. The volume of solder paste depends on PCB and component layout and should be well controlled to ensure consistent mechanical and electrical performance.
- Clean the assembly with alcohol.

Typical Solder Reflow Profiles

Reflow Profile	SnPb	Pb Free
Ramp-up Rate	3 °C/sec	3 °C/sec
Activation Time and Temperature	60 – 120 sec @ 140 – 160 °C	60 – 180 sec @ 150 – 200 °C
Time above Melting Point	60 – 150 sec	60 – 150 sec
Max Peak Temperature	240 °C	260 °C
Time within 5 °C of Peak Temperature	10 – 20 sec	10 – 20 sec
Ramp-down Rate	4 – 6 °C/sec	4 – 6 °C/sec

Ordering Information

Part	Package Style
TGC4403-SM	QFN 4x4 Surface Mount

GaAs MMIC devices are susceptible to damage from Electrostatic Discharge. Proper precautions should be observed during handling, assembly and test.