

Features

- Plastic package has Underwrites Laboratory Flammability Classification 94V-0
- Fast switching speed
- Construction utilizes void-free molded plastic technique
- 1.0A operation at $T_A=75^\circ\text{C}$ with to terminal runaway
- High temperature soldering guaranteed : $250^\circ\text{C}/10$ seconds, 0.375"(9.5mm) lead length, 5 lbs.(2.3kg) tension.

Mechanical Data

- Case : JEDEC DO-41 molded plastic body
- Terminals : Plated axial lead solderable per MIL-STD-750, method 2026
- Polarity : Color band denotes cathode end
- Mounting Position : Any
- Weight : 0.012 ounce, 0.34 gram

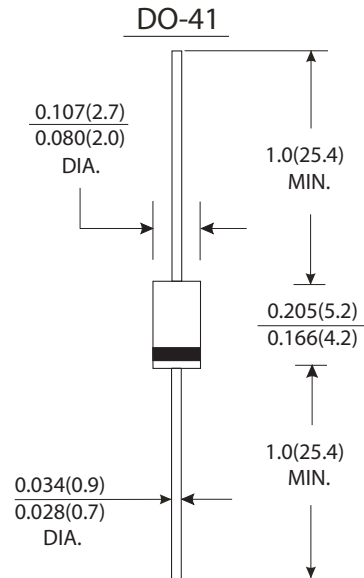

Dimensions in inches and (millimeters)

Maximum Ratings And Electrical Characteristics

(Ratings at 25°C ambient temperature unless otherwise specified, Single phase, half wave 60Hz, resistive or inductive load. For capacitive load, derate by 20%)

	Symbols	1N4933	1N4934	1N4935	1N4936	1N4937	Units
Maximum recurrent peak reverse voltage	V_{RRM}	50	100	200	400	600	Volts
Maximum RMS voltage	V_{RMS}	35	70	140	280	420	Volts
Maximum DC blocking voltage	V_{DC}	50	100	200	400	600	Volts
Maximum average forward rectified current 0.375"(9.5mm) lead length $T_A=75^\circ\text{C}$	$I_{(AV)}$	1.0					Amp
Peak forward surge current 8.3ms single half sine-wave superimposed on rated load (JEDEC method) at $T_A=75^\circ\text{C}$	I_{FSM}	30.0					Amps
Maximum instantaneous forward voltage at 1.0A	V_F	1.3					Volts
Maximum DC reverse current at rated DC blocking voltage	I_R	5.0					μA
Maximum full load reverse current full cycle average. 0.375"(9.5mm) lead length at $T_L=55^\circ\text{C}$		100					
Maximum reverse recovery time (Note 1)	T_{rr}	150					ns
Typical junction capacitance (Note 2)	C_J	15.0					pF
Operating junction and storage temperature range	T_J T_{STG}	-65 to +150					$^\circ\text{C}$

Notes:

- (1) Test conditions: $I_F=1.0A$, $V_R=30V$, $di/dt=50A/\mu S$, and $I_{rr}=10\%I_{RM}$.
- (2) Measured at 1MHz and applied reverse voltage of 4.0 Volts.

RATINGS AND CHARACTERISTIC CURVES 1N4933 THRU 1N4937

FIG.1-TYPICAL FORWARD CURRENT DERATING CURVE

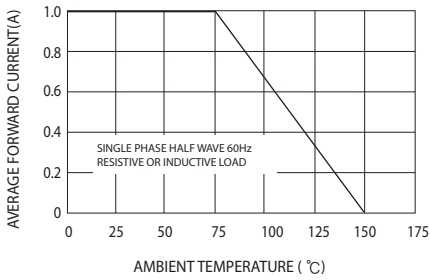

FIG.2-MAXIMUM NON-REPETITIVE FORWARD SURGE CURRENT

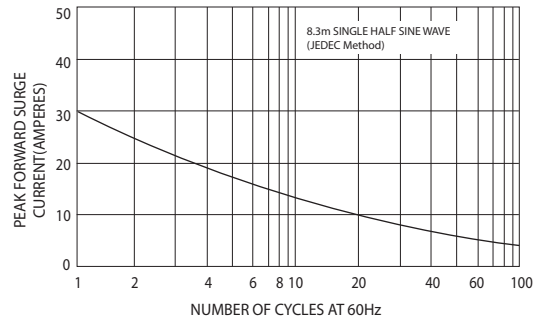

FIG.3-TYPICAL JUNCTION CAPACITANCE

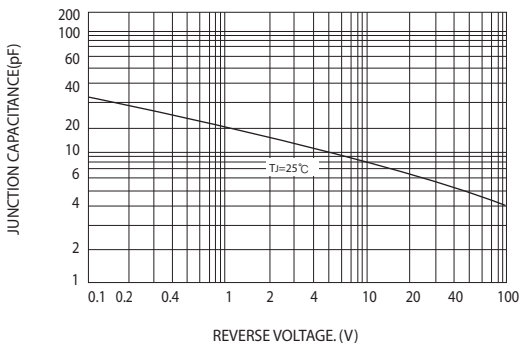

FIG.4-TYPICAL INSTANTANEOUS FORWARD CHARACTERISTICS

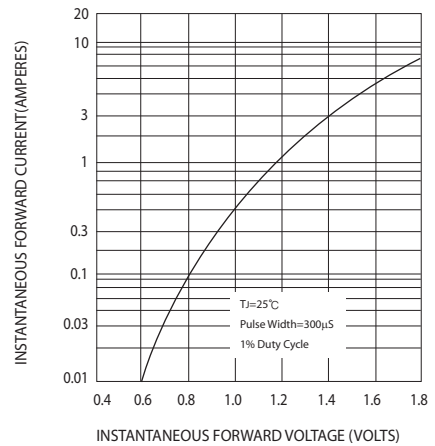
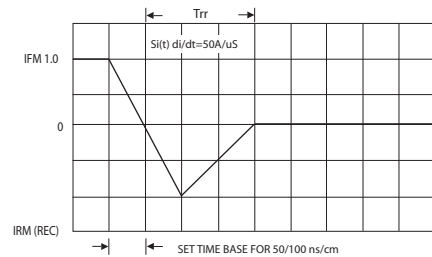
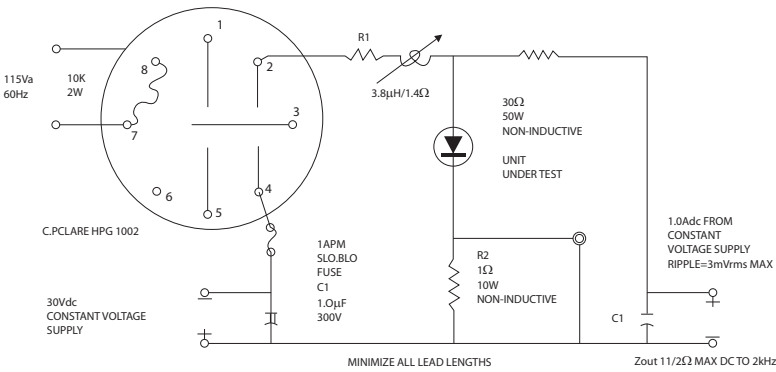

FIG.5-TEST CIRCUIT DIAGRAM AND REVERSE RECOVERY TIME CHARACTERISTIC



A. TEKTRONIX 545A.K PLUG IN PRE AMP P6000 PROBE OR EQUIVALENT R1-ADJUSTED FOR 1.4Ω BETWEEN POINT 2 OF RELAY AND RECTIFIER INDUCTIVE=3.8µH
 R2-TEN-1W 10Ω% CARBON CORE IN PARALLEL TA=25 +10°C FOR RECTIFIER