

1mm contact gap.
1a 10A/16A power relays
TV-5 rated

LK-G RELAYS



FEATURES

- Contact gap: 1 mm .039 inch**
- Wide lineup of 3 types available**
 - 10A, 1 mm contact gap type
 - 16A, 1 mm contact gap type
 - 16 A standard type
- High inrush current capability (TV-5 approved)**
- High insulation resistance**
 - Creepage distance and clearances between contact and coil: Min. 6 mm .236 inch (In compliance with IEC60065)
 - Surge withstand voltage between contact and coil: 10,000 V

TYPICAL APPLICATIONS

- Audio visual equipment
- HA equipment
- Home appliances
- Office equipment

Compliance with RoHS Directive

ORDERING INFORMATION

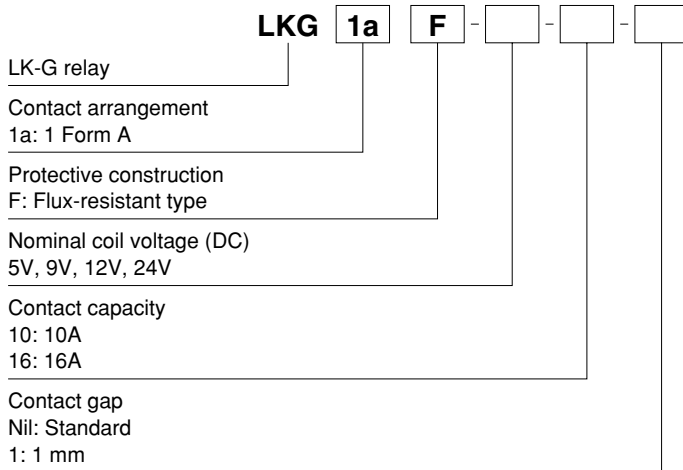

TYPES

Contact arrangement	Nominal coil voltage	Part No.		
		10A, 1 mm contact gap type	16A, 1 mm contact gap type	16 A standard type
1 Form A	5V DC	LKG1aF-5V-10-1	LKG1aF-5V-16-1	LKG1aF-5V-16
	9V DC	LKG1aF-9V-10-1	LKG1aF-9V-16-1	LKG1aF-9V-16
	12V DC	LKG1aF-12V-10-1	LKG1aF-12V-16-1	LKG1aF-12V-16
	24V DC	LKG1aF-24V-10-1	LKG1aF-24V-16-1	LKG1aF-24V-16

Standard packing: Carton: 100 pcs.; Case: 500 pcs.

RATING

1. Coil data

Nominal coil voltage	Pick-up voltage (at 20°C 68°F)	Drop-out voltage (at 20°C 68°F)	Nominal operating current [±10%] (at 20°C 68°F)	Coil resistance [±10%] (at 20°C 68°F)	Nominal operating power	Max. applied voltage (at 20°C 68°F)
5V DC	75%V or less of nominal voltage (Initial)	10%V or more of nominal voltage (Initial)	106.4mA	47Ω	530mW	130%V of nominal voltage
9V DC			58.8mA	153Ω		
12V DC			44.2mA	272Ω		
24V DC			22.1mA	1,087Ω		

2. Specifications

Characteristics	Item	Specifications			
		10A, 1 mm contact gap type	16A, 1 mm contact gap type	16 A standard type	
Contact	Arrangement	1 Form A			
	Contact resistance (Initial)	Max. 100 mΩ (By voltage drop 6 V DC 1A)			
	Contact material	AgSnO ₂ type			
Rating	Nominal switching capacity (resistive load)	10A 277V AC	16A 277V AC		
	Max. switching power (resistive load)	2,770VA	4,432VA		
	Max. switching voltage	277V AC	277V AC		
	Max. switching current	10A (AC)	16A (AC)		
	Min. switching capacity*1	100mA 5V DC			
Electrical characteristics	Contact gap	Min. 1 mm .039 inch		—	
	Insulation resistance (Initial)	Min. 1,000MΩ (at 500V DC) Measurement at same location as "Breakdown voltage" section.			
	Breakdown voltage (Initial)	Between open contacts	1,000 Vrms for 1 min. (Detection current: 10 mA)		
		Between contact and coil	4,000 Vrms for 1 min. (Detection current: 10 mA)		
	Temperature rise (coil)	Max. 45°C 113°F (By resistive method, nominal voltage applied to the coil; contact carrying current: 10A, at 70°C 158°F)		Max. 45°C 113°F (By resistive method, nominal voltage applied to the coil; contact carrying current: 16A, at 70°C 158°F)	
		Surge breakdown voltage*2 (Between contact and coil) (Initial)			
	Operate time (at nominal voltage) (at 20°C 68°F) (Initial)		Max. 15 ms (excluding contact bounce time.)		
	Release time (at nominal voltage) (at 20°C 68°F) (Initial)		Max. 20 ms (excluding contact bounce time.) (with diode)		
Mechanical characteristics	Shock resistance	Functional	200 m/s ² (Half-wave pulse of sine wave: 11 ms; detection time: 10μs.)		
		Destructive	1,000 m/s ² (Half-wave pulse of sine wave: 6 ms.)		
	Vibration resistance	Functional	10 to 55 Hz at double amplitude of 1.5 mm (Detection time: 10μs.)		
		Destructive	10 to 55 Hz at double amplitude of 1.5 mm		
Expected life	Mechanical	Min. 2×10 ⁶ (at 180 times/min.)			
	Electrical	Min. 10 ⁵ (at 6 times/min.) (with diode)	Min. 5×10 ⁴ (at 6 times/min.) (with diode)		
Conditions	Conditions for operation, transport and storage*3	Ambient temperature: -40°C to +70°C -40°F to +158°F; Humidity: 5 to 85% R.H. (Not freezing and condensing at low temperature); Air pressure: 86 to 106 kPa			
	Max. operating speed	6 times/min. (at rated load)			
Unit weight	Approx. 12 g .42 oz				

Notes: *1. This value can change due to the switching frequency, environmental conditions, and desired reliability level, therefore it is recommended to check this with the actual load.

*2. Wave is standard shock voltage of ±1.2×50μs according to JEC-212-1981

*3. The upper limit of the ambient temperature is the maximum temperature that can satisfy the coil temperature rise value. Refer to Usage, transport and storage conditions in NOTES.

REFERENCE DATA

1. Max. switching power (AC resistive load)

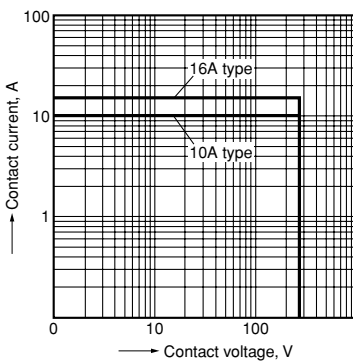

2. Ambient temperature characteristics and coil applied voltage

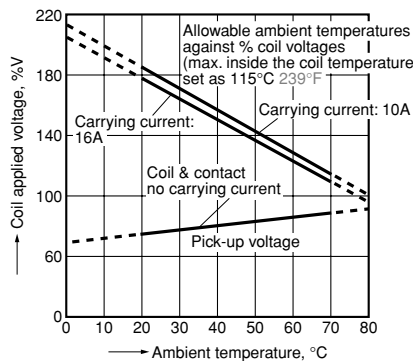

LK-G

3-(1). Electrical life test (10A type)

Sample: LKG1aF-12V-10-1, 6 pcs.
 Operation frequency: 6 times/min.
 (ON/OFF = 1s: 9s)
 Ambient temperature: 20°C 68°F

Circuit:

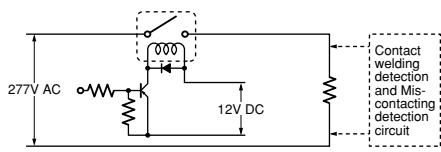

Change of pick-up and drop-out voltage

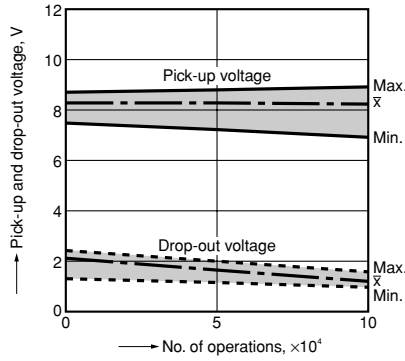

Change of contact resistance

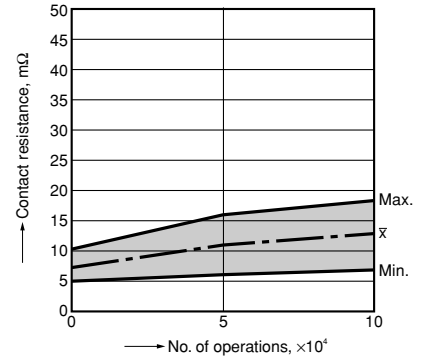

3-(2). Electrical life test (16A type)

Sample: LKG1aF-12V-16-1, 6 pcs.
 Operation frequency: 6 times/min.
 (ON/OFF = 1s: 9s)
 Ambient temperature: 20°C 68°F

Circuit:

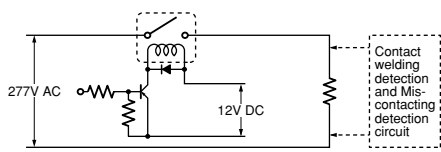

Change of pick-up and drop-out voltage

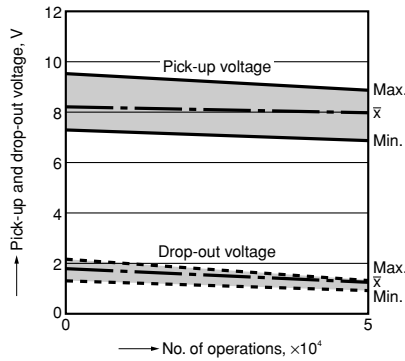

Change of contact resistance

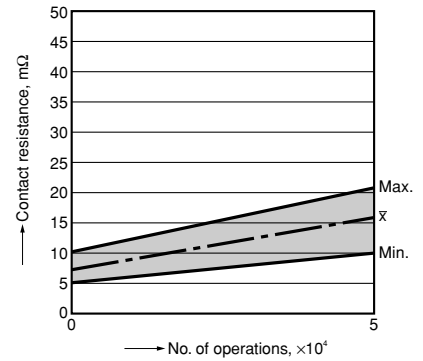

DIMENSIONS (mm inch)

The CAD data of the products with a **CAD Data** mark can be downloaded from: <http://panasonic-electric-works.net/ac>

CAD Data

External dimensions

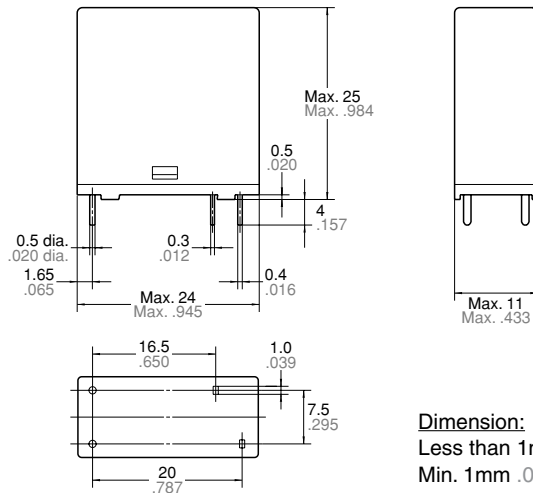

PC board pattern (Bottom view)

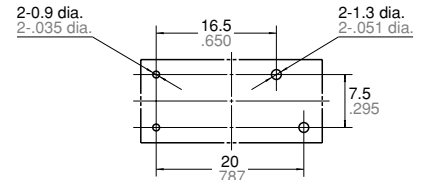

Tolerance: $\pm 0.1 \pm 0.004$

Schematic (Bottom view)



Dimension:

Less than 1mm .039inch:

Min. 1mm .039inch less than 3mm .118 inch: $\pm 0.2 \pm 0.008$

Min. 3mm .118 inch:

General tolerance

$\pm 0.1 \pm 0.004$

$\pm 0.2 \pm 0.008$

$\pm 0.3 \pm 0.012$

SAFETY STANDARDS

Item	UL/C-UL (Recognized)		TÜV (Certified)	
	File No.	Contact rating	File No.	Rating
10A type	E43149	TV-5, 10A 277V AC	B 09 05 13461 262	10A 250V AC ($\cos\phi=1.0$), 10A 30V DC (0ms)
16A type	E43149	TV-5, 16A 125V AC	B 09 05 13461 262	16A 250V AC ($\cos\phi=1.0$), 16A 30V DC (0ms)

For Cautions for Use.