

Mini half-watt SMD 3.5mm (120° Viewing Angle)

OVS5MxBCR4 Series

- Compact Package Outline of 3.5 x 3.5 x 1.2 mm
- Robust energy-efficient design with long operating life
- Low thermal resistance
- Exceptional spatial uniformity
- Compatible to IR reflow soldering
- High Lumens output

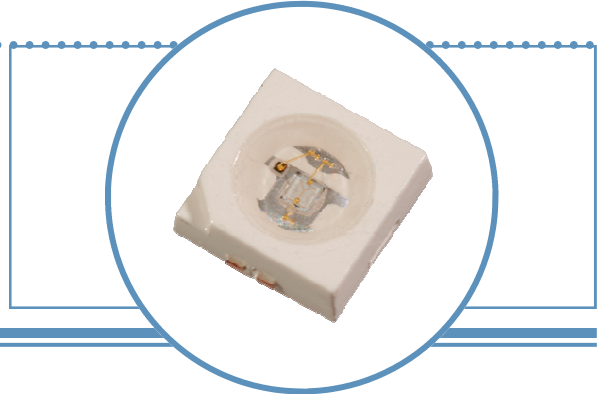

The **mini-half watt** is an energy-efficient packaged LED source that offers high luminance, and a long operating lifespan. This device offers a 120° viewing angle and an ultra-low profile (1.2 mm) making it highly suitable for conventional lighting and specialized applications.

Applications

- Automotive exterior and interior lighting
- Architectural indoor and outdoor lighting
- General lighting
- Display Backlighting
- Electronic signs and signals

Part Number	Viewing Angle	Emitted Color	Typ. Luminous Flux (lm)	Forward Voltage V_F	Power Dissipation @ 150 mA	Lens Color
OVS5MWBCR4	120	White	30	3.4	0.51 W	Clear
OVS5MWWBCR4		Warm White	30	3.6	0.54 W	
OVS5MBBCR4		Blue	6	3.4	0.51 W	
OVS5MGBCR4		Green	22	3.4	0.51 W	

Part Number	Viewing Angle	Emitted Color	Typ. Luminous Intensity (mcd)	Forward Voltage V_F	Power Dissipation @ 150 mA	Lens Color
OVS5MRBCR4	120	Red	7150	2.2	0.33 W	Clear
OVS5MABCR4		Amber	7150	2.2	0.33 W	
OVS5MYBCR4		Yellow	7150	2.2	0.33 W	

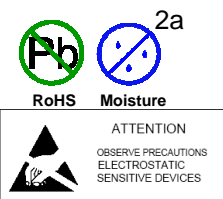

DO NOT LOOK DIRECTLY AT LED WITH UNSHIELDED EYES OR DAMAGE TO RETINA MAY OCCUR.

OPTEK reserves the right to make changes at any time in order to improve design and to supply the best product possible.

Mini half-watt SMD 3.5mm OVS5MxBCR4

Absolute Maximum Ratings $T_A = 25^\circ\text{C}$

	Red, Amber, Yellow	Green, Blue	White	Warm White
DC Forward Current	200 mA	180 mA		
Peak Pulsed Forward Current ¹	1000 mA	350 mA		
Reverse Voltage	12V @ 10 uA	Not designed for reverse bias		
Junction Temperature ²	125°C			
Power Dissipation	750mW			
Storage and Operating Temperature	-40° ~ +100 °C			
ESD (JEDEC-JESD22-A114F)	Class 2			
MSL (IPC / JEDEC J-STD-020C)	2a / 672 Hrs			

Notes:

1. Pulse width $t_p \leq 10\mu\text{s}$, Duty cycle = 0.1
2. Thermal Resistance = 5 C/W

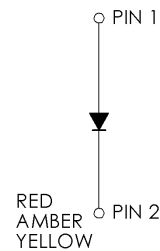
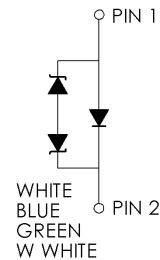
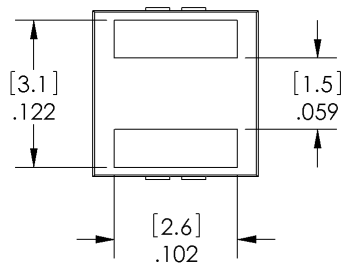
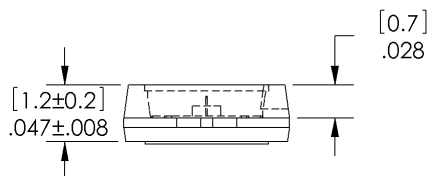
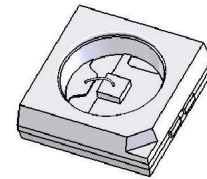
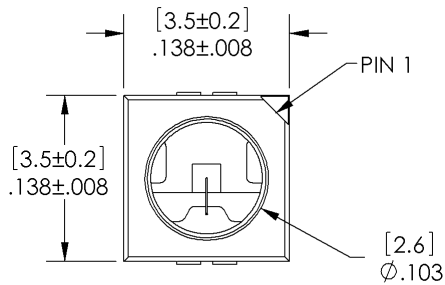

PIN 1	ANODE
PIN 2	CATHODE

DIMENSIONS ARE IN INCHES [MM].

OPTEK reserves the right to make changes at any time in order to improve design and to supply the best product possible.

Optical and Electrical Characteristics - Red, Amber, Yellow ($I_F = 140 \text{ mA}$, $T_A = 25^\circ\text{C}$)

SYMBOL	PARAMETER	MIN	TYP	MAX	UNITS	
V_F	Forward Voltage	1.9	2.2	2.65	V	
Φ	Luminous Intensity	Red	4500	7150	9000	mcd
		Amber				
		Yellow				
λ_D	Dominant Wavelength	Red	620	625	630	nm
		Amber	610	615	621	
		Yellow	585	590	594	
I_R	Reverse Current @ 12 V	----	10	----	μA	
$2\theta_{1/2}$	50% Power Angle	----	120	----	deg	

Optical and Electrical Characteristics - Blue, Green ($I_F = 150 \text{ mA}$, $T_A = 25^\circ\text{C}$)

SYMBOL	PARAMETER	MIN	TYP	MAX	UNITS	
V_F	Forward Voltage	3.0	3.4	3.9	V	
Φ	Luminous Flux	Blue	4.9	6.0	8.2	lm
		Green	18.1	22.0	30.6	
λ_D	Dominant Wavelength	Blue	460	465	470	nm
		Green	520	525	535	
$2\theta_{1/2}$	50% Power Angle	----	120	----	deg	

Optical and Electrical Characteristics - White, Warm White ($I_F = 150 \text{ mA}$, $T_A = 25^\circ\text{C}$)

SYMBOL	PARAMETER	MIN	TYP	MAX	UNITS	
V_F	Forward Voltage	3.0	White	3.4	4.1	V
			Warm White	3.6		
Φ	Luminous Flux	23.5	White	30.6	39.8	lm
			Warm White			
$2\theta_{1/2}$	50% Power Angle	----	120	----	deg	

OPTEK reserves the right to make changes at any time in order to improve design and to supply the best product possible.

Standard Bins

LEDs are sorted to luminous intensity (I_v) or luminous flux (Φ) and dominant wavelength (nm) bins shown. Each reel consists of a single intensity bin and a single color bin. Orders are filled using all intensity and color bins listed in the following tables. Optek will not accept orders for single intensity bins or single color bins.

Luminous Flux (Φ) @ 150mA (lm)

Blue: OVS5MBBCR4		
IV Code	Min (lm)	Max (lm)
H2	4.9	5.5
H3	5.5	6.3
J2	6.3	7.1
J3	7.1	8.2
Green: OVS5MGBCR4		
IV Code	Min (lm)	Max (lm)
N2	18.1	20.6
N3	20.6	23.5
P2	23.5	26.8
P3	26.8	30.6

Dominant Wavelength (nm)

Blue: OVS5MBBCR4		
nm Code	Min (nm)	Max (nm)
A	460	465
B	465	470
Green: OVS5MGBCR4		
nm Code	Min (nm)	Max (nm)
A	520	525
B	525	530
C	530	535

Luminous Intensity (I_v) @ 140mA

Amber: OVS5MABCR4		
IV Code	Min (mcd)	Max (mcd)
Z1	4500	5600
Z2	5600	7150
AA	7150	9000
Red: OVS5MRBCR4		
IV Code	Min (mcd)	Max (mcd)
Z1	4500	5600
Z2	5600	7150
AA	7150	9000
Yellow: OVS5MYBCR4		
IV Code	Min (mcd)	Max (mcd)
Z1	4500	5600
Z2	5600	7150
AA	7150	9000

Dominant Wavelength (nm)

Amber: OVS5MABCR4		
nm Code	Min (nm)	Max (nm)
W	610	615
X	615	621
Red: OVS5MRBCR4		
nm Code	Min (nm)	Max (nm)
Full	620	630
Yellow: OVS5MYBCR4		
nm Code	Min (nm)	Max (nm)
X	585	588
Y	588	591
Z	591	594

OPTEK reserves the right to make changes at any time in order to improve design and to supply the best product possible.

Standard Bins ($I_F = 150\text{mA}$)

LEDs are sorted to luminous flux (Φ) and chromaticity coordinates (x, y) bins shown. Each reel consists of a single intensity bin and a single chromaticity bin. Orders are filled using all intensity and chromaticity bins listed in the following table. Optek will not accept orders for single intensity bins or single chromaticity bins.

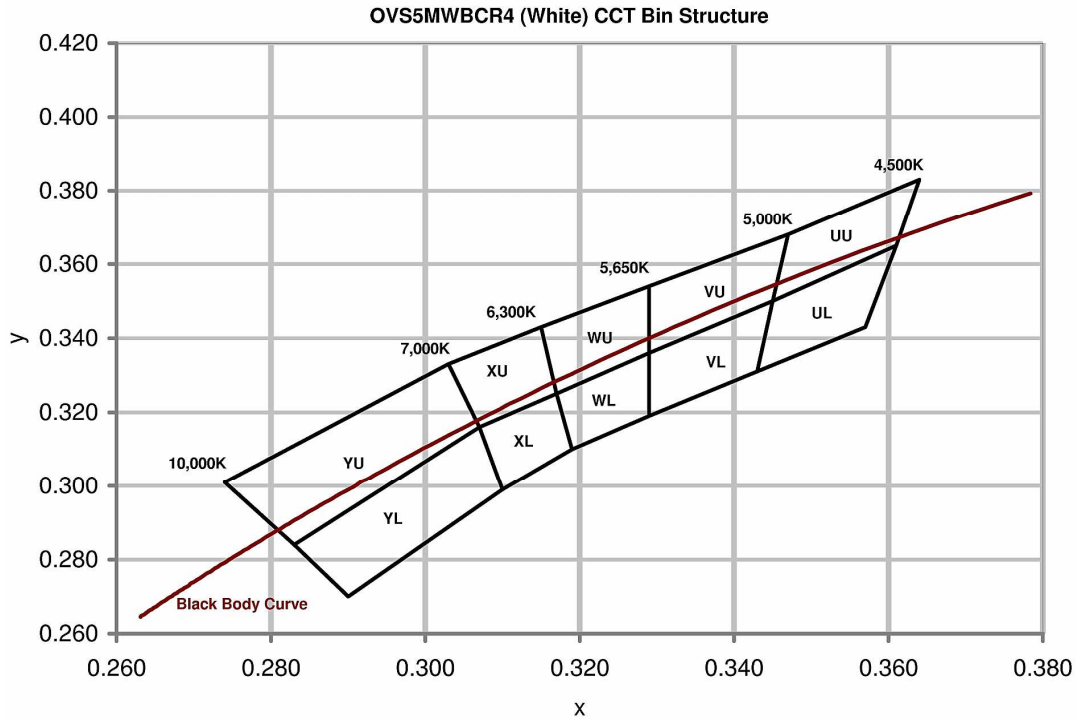

Chromaticity Coordinates (x, y)

Rank	YU				YL			
Cx	0.274	0.283	0.307	0.303	0.283	0.290	0.310	0.307
Cy	0.301	0.284	0.316	0.333	0.284	0.270	0.299	0.316
Rank	XU				XL			
Cx	0.303	0.307	0.317	0.315	0.307	0.310	0.319	0.317
Cy	0.333	0.316	0.325	0.343	0.316	0.299	0.310	0.325
Rank	WU				WL			
Cx	0.315	0.317	0.329	0.329	0.317	0.319	0.329	0.329
Cy	0.343	0.325	0.336	0.354	0.325	0.310	0.319	0.336
Rank	VU				VL			
Cx	0.329	0.329	0.345	0.347	0.329	0.329	0.343	0.345
Cy	0.354	0.336	0.350	0.368	0.336	0.319	0.331	0.350
Rank	UU				UL			
Cx	0.347	0.345	0.361	0.364	0.345	0.343	0.357	0.361
Cy	0.368	0.350	0.365	0.383	0.350	0.331	0.343	0.365

Φ	Luminous Flux (lm)	
Bin	Min	Max
P2	23.5	26.8
P3	26.8	30.6
Q2	30.6	34.8
Q3	34.8	39.8

OPTEK reserves the right to make changes at any time in order to improve design and to supply the best product possible.

Standard Bins ($I_F = 150\text{mA}$)

LEDs are sorted to luminous flux (Φ) and chromaticity coordinates (x, y) bins shown. Each reel consists of a single intensity bin and a single chromaticity bin. Orders are filled using all intensity and chromaticity bins listed in the following table. Optek will not accept orders for single intensity bins or single chromaticity bins.

OVS5MWWBCR4 (Warm White) CCT Bin Structure

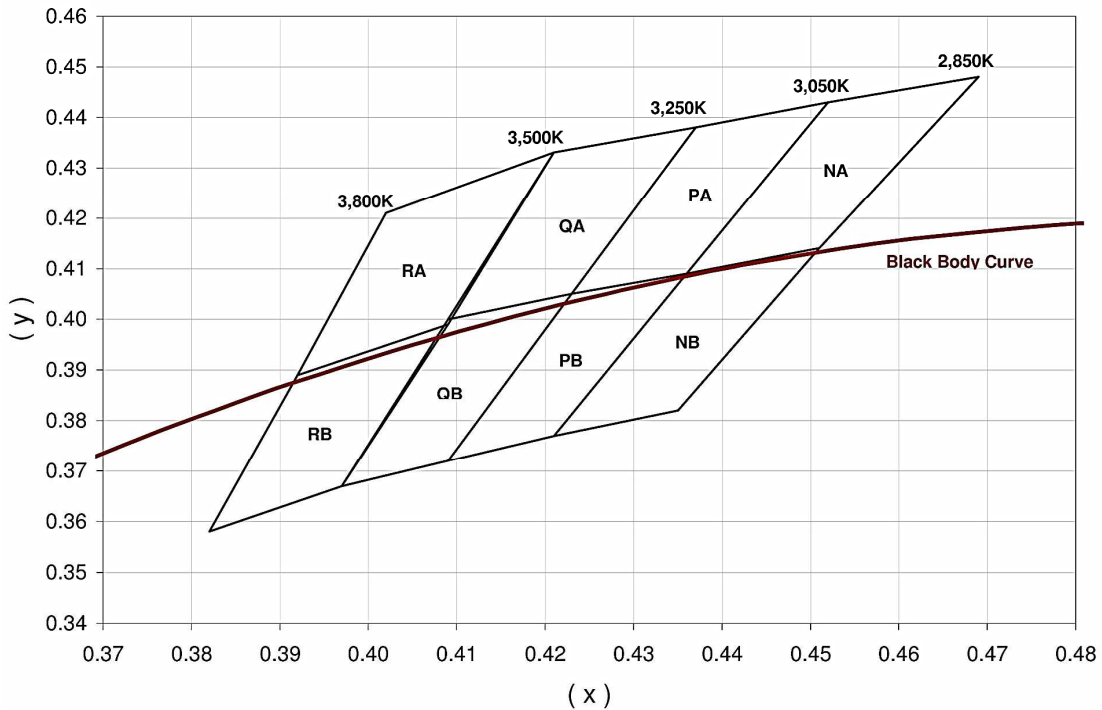

Chromaticity Coordinates (x, y)

Rank	RA				RB			
Cx	0.402	0.392	0.409	0.421	0.392	0.382	0.397	0.409
Cy	0.421	0.389	0.399	0.433	0.389	0.358	0.367	0.399
Rank	QA				QB			
Cx	0.421	0.409	0.423	0.437	0.409	0.397	0.409	0.423
Cy	0.433	0.400	0.405	0.438	0.400	0.367	0.372	0.405
Rank	PA				PB			
Cx	0.437	0.423	0.436	0.452	0.423	0.409	0.421	0.436
Cy	0.438	0.405	0.409	0.443	0.405	0.372	0.377	0.409
Rank	NA				NB			
Cx	0.452	0.436	0.451	0.469	0.436	0.421	0.435	0.451
Cy	0.443	0.409	0.414	0.448	0.409	0.377	0.382	0.414

Φ	Luminous Flux (lm)	
Bin	Min	Max
P2	23.5	26.8
P3	26.8	30.6
Q2	30.6	34.8
Q3	34.8	39.8

OPTEK reserves the right to make changes at any time in order to improve design and to supply the best product possible.

OVS5MABCR4 (Amber), OVS5MRBCR4 (Red) and OVS5MYBCR4 (Yellow)

Relative Intensity Vs Forward Current

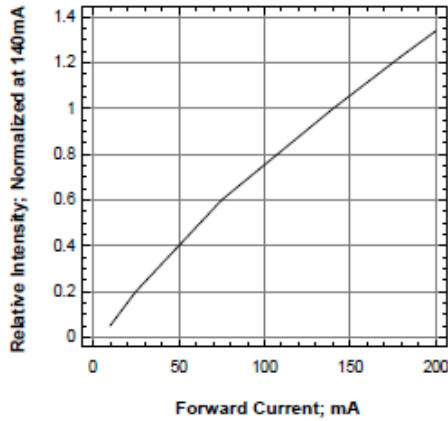

Forward Voltage Vs Forward Current

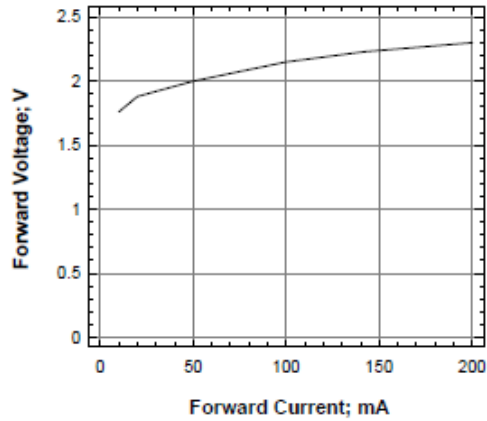

Maximum Current Vs Ambient Temperature

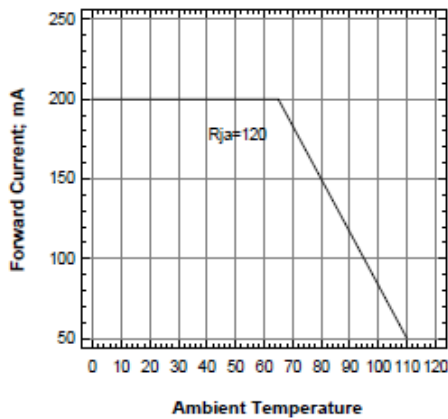

Maximum Current vs Solder-Point Temperature

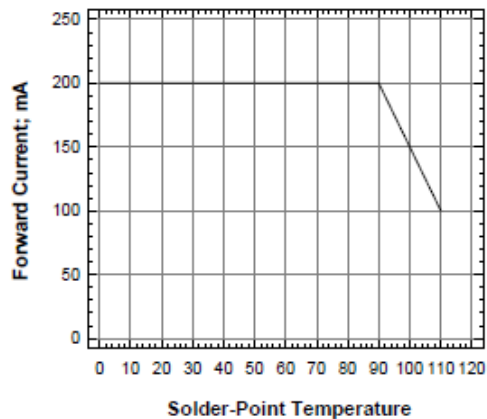

Relative Intensity Vs Wavelength

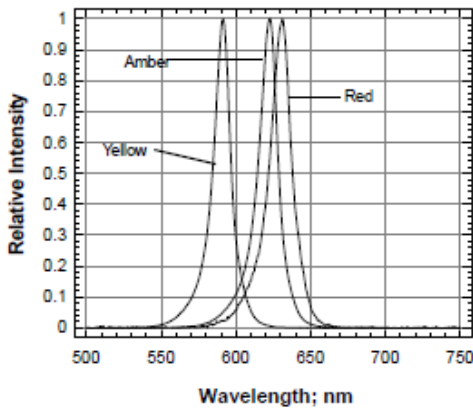

Allowable Forward Current Vs Duty Ratio

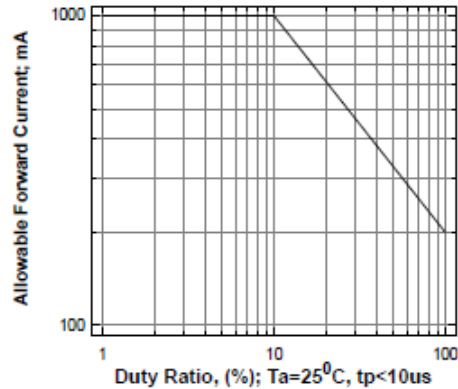

OPTEK reserves the right to make changes at any time in order to improve design and to supply the best product possible.

OVS5MBCR4 (Blue), OVS5MGBCR4 (Green), OVS5MWBCR4 (White) and OVS5MWWBCR4 (Warm White)

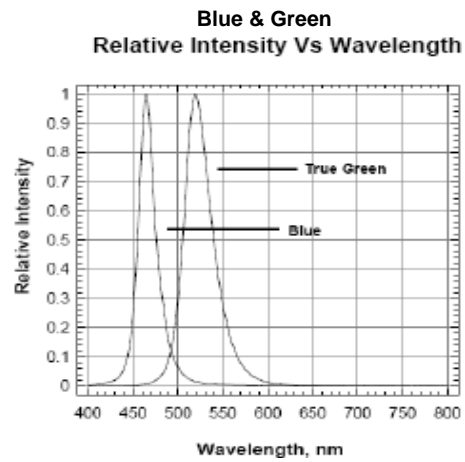
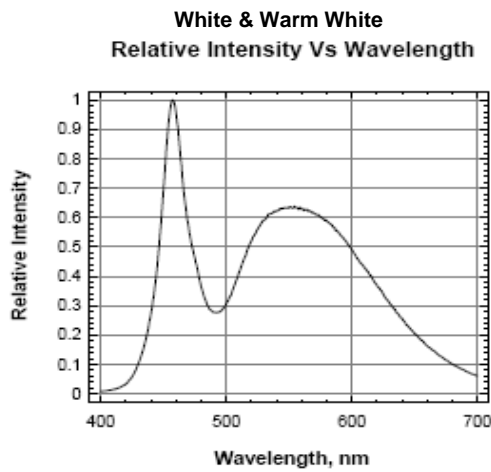
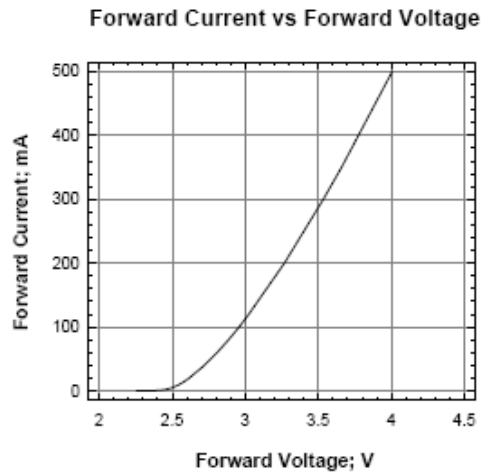
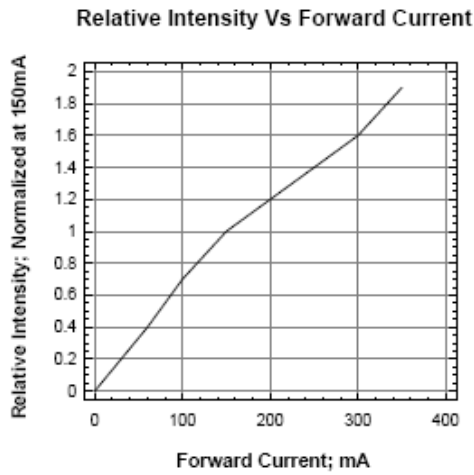

Forward Current Vs Ambient Temperature

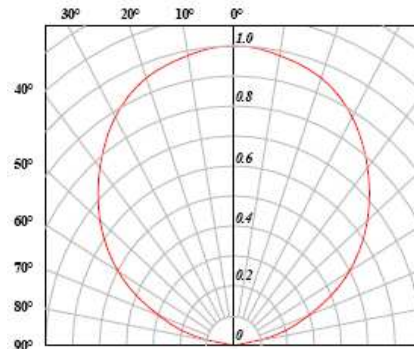
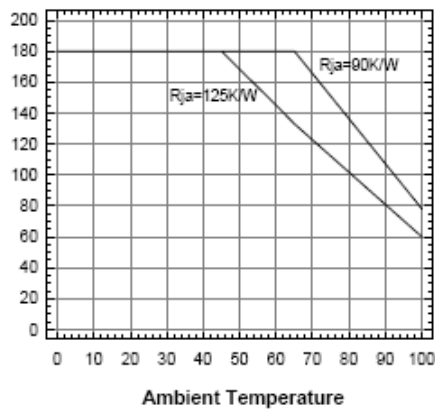

Beam Angle: All Colors

OPTeK reserves the right to make changes at any time in order to improve design and to supply the best product possible.

Solder Pad Design

Note: Metal core circuit board (MCPCB) is highly recommended for high density applications. FR-4 board is recommended for other applications

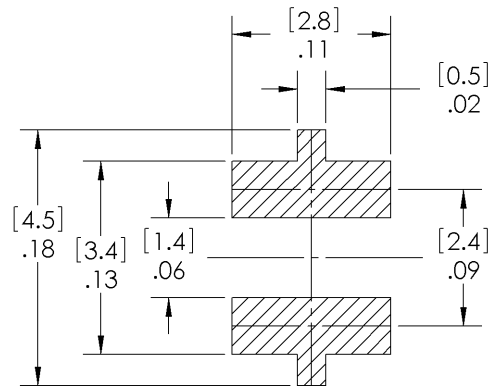

Solder Paste Pattern

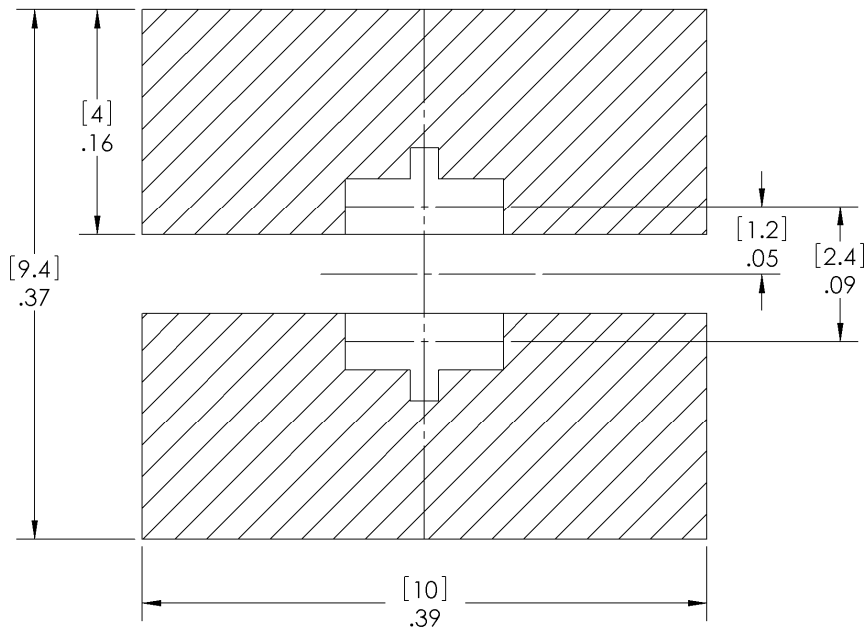

Copper Pattern

OPTEK reserves the right to make changes at any time in order to improve design and to supply the best product possible.

Recommended Sn-Pb IR-Reflow Soldering Profile.

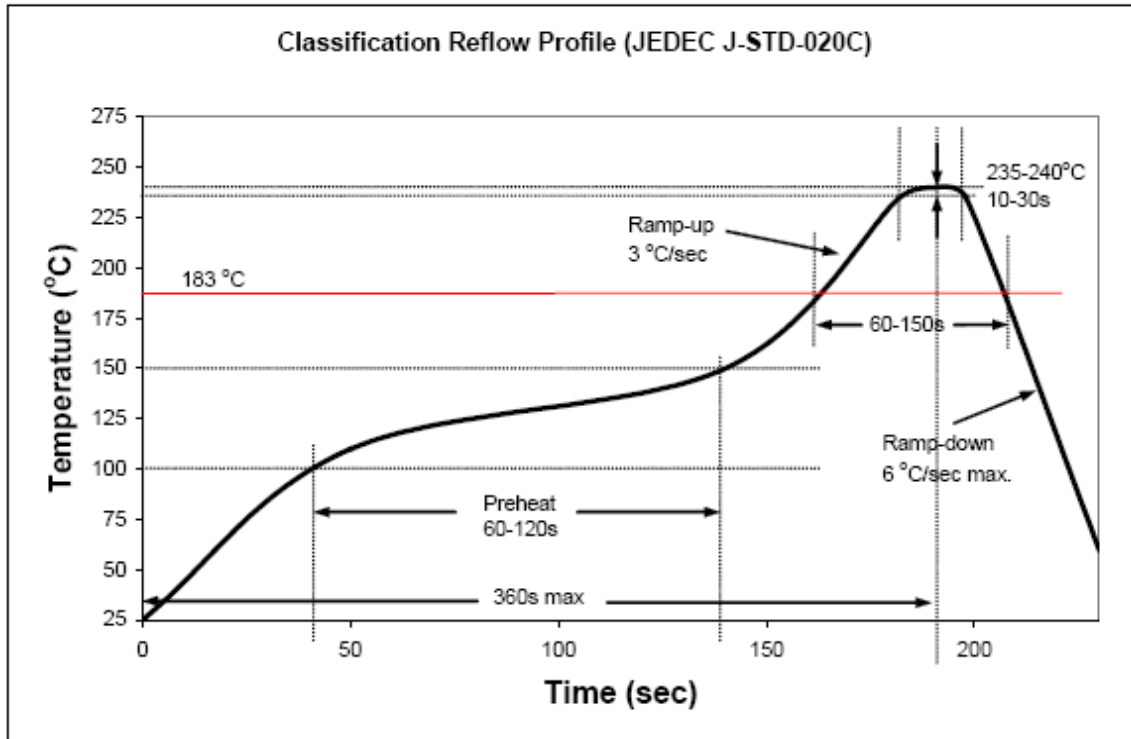

Recommended Pb Free IR-Reflow Soldering Profile.

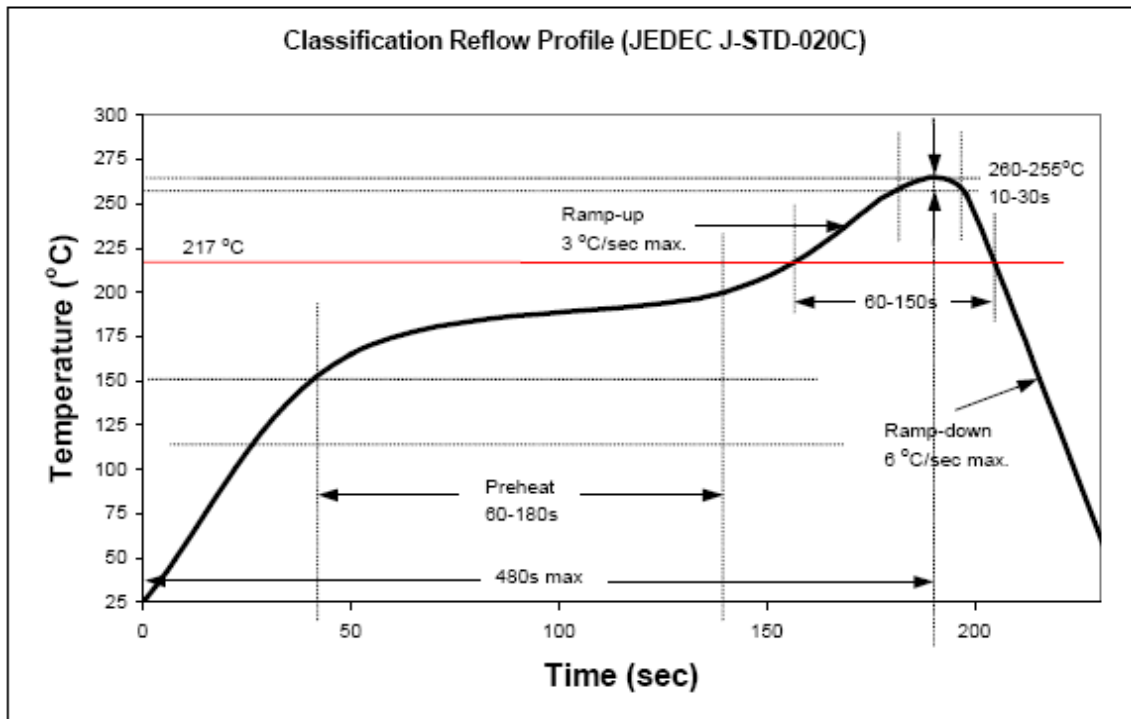

OPTeK reserves the right to make changes at any time in order to improve design and to supply the best product possible.

Reel Dimensions: 7-inch reel

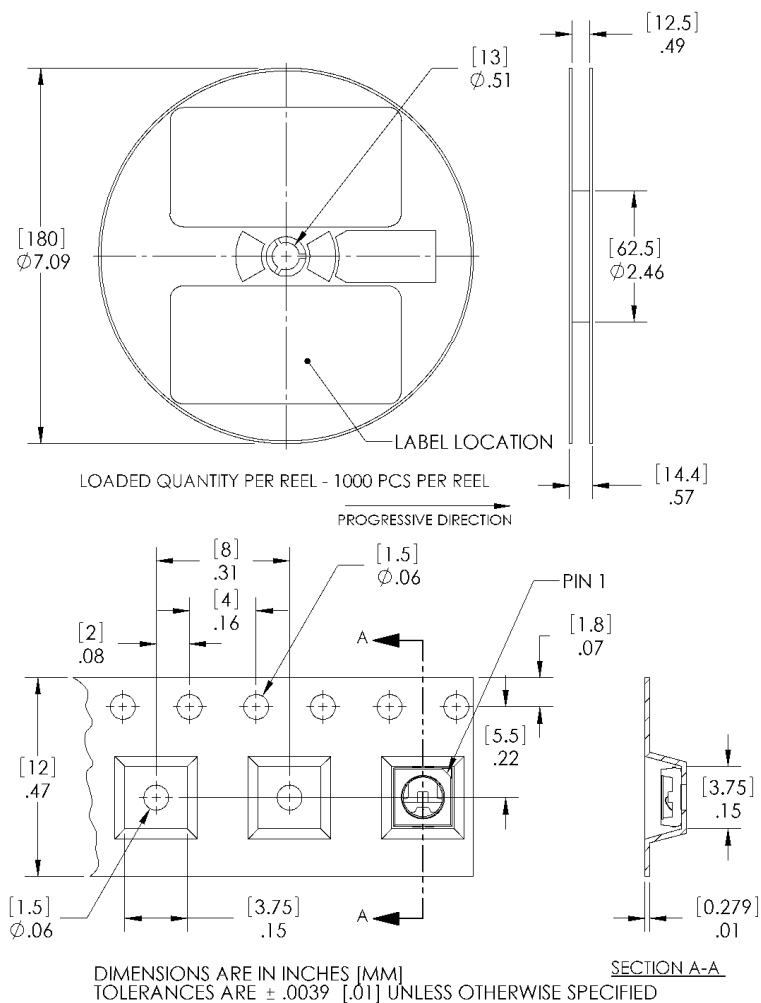

Carrier Tape Dimensions: Loaded quantity 1000 pieces per reel

Moisture Resistant Packaging

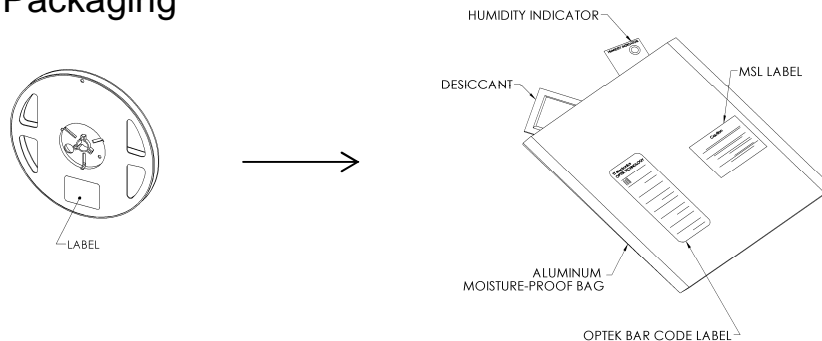

OPTEK reserves the right to make changes at any time in order to improve design and to supply the best product possible.