



# MCA230/231/255

## Photodarlington Optocoupler

### FEATURES

- **CTR Minimum**  
MCA230/255, 100%  
MCA231, 200%
- **Isolation Test Voltage, 5300 V<sub>RMS</sub>**
- **Coupling Capacitance, 0.5 pF**
- **Fast Rise Time, 10 μs**
- **Fast Fall Time, 35 μs**
- **Underwriters Lab File #E52744**
- **VDE #0884 Available with Option 1**

### DESCRIPTION

The MCA230/231/255 are industry standard optocouplers, consisting of a Gallium Arsenide infrared LED and a silicon photodarlington. These optocouplers are constructed with a high voltage insulation, double molded packaging process which offers 7.5 kV withstand test capability.

### Maximum Ratings

#### Emitter

Reverse Voltage.....6.0 V  
 Continuous Forward Current .....60 mA  
 Power Dissipation at 25°C.....135 mW  
 Derate Linearly from 25°C .....1.8 mW/°C  
 Detector

Collector-Emitter Breakdown Voltage  
 MCA230/231 .....30 V  
 MCA255 .....55 V  
 Emitter-Collector Breakdown Voltage .....7.0 V  
 Collector-Base Breakdown Voltage  
 MCA230/231 .....30 V  
 MCA255 .....55 V  
 Power Dissipation at 25°C.....210 mW  
 Derate Linearly from 25°C .....2.8 mW/°C

#### Package

Total Package Dissipation at 25°C  
 (LED plus Detector) .....260 mW  
 Derate Linearly from 25°C .....3.5 mW/°C  
 Storage Temperature .....-55°C to +150°C  
 Operating Temperature .....-55°C to +100°C  
 Lead Soldering Time at 260°C .....10 sec.  
 Isolation Test Voltage .....5300 V<sub>RMS</sub>  
 Isolation Resistance  
 $V_{IO}=500\text{ V}, T_A=25^\circ\text{C}$ ..... $10^{12}\ \Omega$   
 $V_{IO}=500\text{ V}, T_A=100^\circ\text{C}$ ..... $10^{11}\ \Omega$

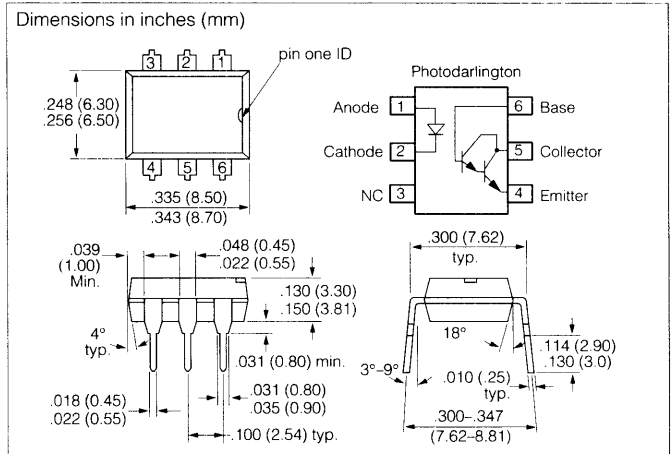

### Characteristics ( $T_A=25^\circ\text{C}$ )

	Symbol	Min.	Typ.	Max.	Unit	Condition
<b>Emitter</b>						
Forward Voltage	$V_F$	—	1.1	1.5	V	$I_F=50\text{ mA}$
Reverse Current	$I_R$	—	—	10	$\mu\text{A}$	$V_R=3.0\text{ V}$
Junction Capacitance	$C_J$	—	50	—	pF	$V_R=3.0\text{ V}$
<b>Detector</b>						
$BV_{CEO}$	—	30	—	—	V	$I_C=100\ \mu\text{A}, I_F=0\text{ mA}$
MCA230/231 MCA255	—	30	—	—	V	$I_C=100\ \mu\text{A}, I_F=0\text{ mA}$
$BV_{ECO}$	—	7.0	—	—	V	$I_E=10\ \mu\text{A}, I_F=0\text{ mA}$
$BV_{CBO}$	—	30	—	—	V	$I_C=10\ \mu\text{A}, I_F=0\text{ mA}$
MCA230/231 MCA55	—	55	—	—	V	$I_C=10\ \mu\text{A}, I_F=0\text{ mA}$
$I_{CEO}$	—	—	—	100	nA	$V_{CE}=10\text{ V}, I_F=0\text{ mA}$
<b>Package</b>						
$V_{CESat}$	—	—	—	0.8 1.0 1.0 1.0 1.2	V	$I_{CE}=2.0\text{ mA}, I_F=16\text{ mA}$ $I_C=I_F=50\text{ mA}$ $I_C=2.0\text{ mA}, I_F=1.0\text{ mA}$ $I_C=10\text{ mA}, I_F=5.0\text{ mA}$ $I_C=50\text{ mA}, I_F=10\text{ mA}$
DC Current Transfer Ratio	CTR	100	—	—	%	$V_{CE}=5.0\text{ V}, I_F=10\text{ mA}$
MCA230/255 MCA231	CTR	200	—	—	%	$V_{CE}=5.0\text{ V}, I_F=1.0\text{ mA}$
Capacitance Input to Output	$C_{IO}$	—	0.5	—	pF	—
Switching Times	$t_{on}$	—	10	—	$\mu\text{s}$	$R_L=100\ \Omega$
	$t_{off}$	—	35	—	$\mu\text{s}$	$V_{CE}=10\text{ V}$

**Figure 1. Forward voltage versus forward current**

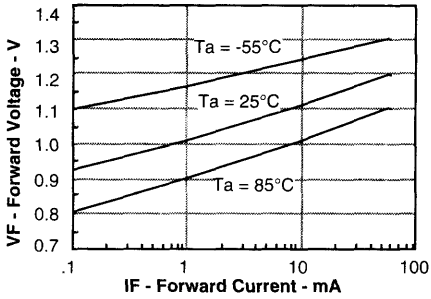

**Figure 2. Normalized non-saturated and saturated CTRce at TA=25°C versus LED current**

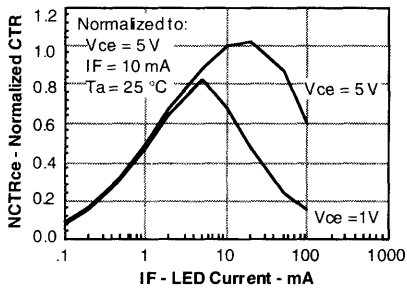

**Figure 3. Normalized non-saturated and saturated collector-emitter current versus LED current**

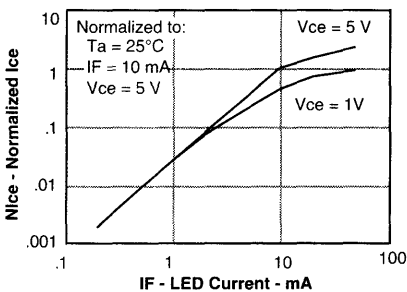

**Figure 4. Normalized collector-base photocurrent versus LED current**

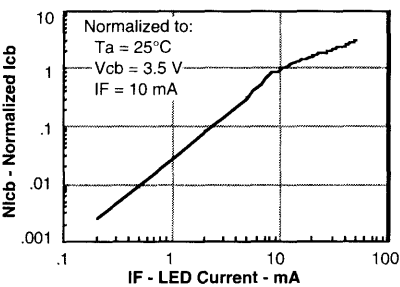

**Figure 5. Non-saturated and saturated HFE versus base current**

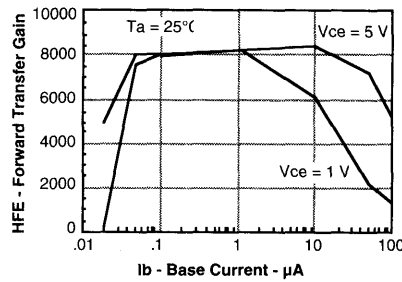

**Figure 6. Low to high propagation delay versus collector load resistance and LED current**

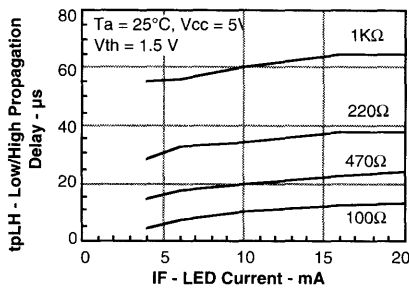

**Figure 7. High to low propagation delay versus collector load resistance and LED current**

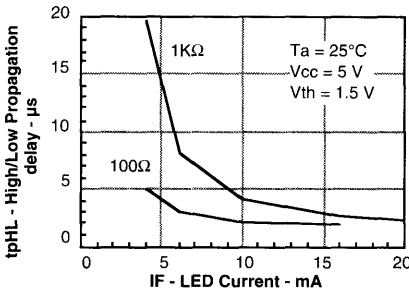

**Figure 8. Switching timing waveform and schematic**

