



KERSEMI

Power Schottky Rectifier - 20Amp 60Volt

Features

- Plastic package has Underwriters Laboratory Flammability Classifications 94V-0
- High Junction Temperature Capability
- Low forward voltage, high current capability
- High surge capacity
- Low power loss, high efficiency
- Halogen-Free

Application

- Switching-Mode Power Supply
- Solar-System Control Box

Absolute maximum ratings

Symbol	Ratings	Unit	Conditions
$I_F(AV)$	20	A	Average Forward Current
V_{RRM}	60	V	Repetitive Peak Reverse Voltage
I_{FSM}	150	A	Peak Forward Surge Current
V_F	0.62	V	Forward Voltage Drop
T_j, T_{stg}	-50 to +175	°C	Operating and Storage Temperature

Electrical characteristics

Parameters	Symbol	Ratings	Conditions
Maximum Instantaneous Forward Voltage	V_F	0.78V	Per Leg at $I_F = 10A$ $T_c = 25^\circ C$
		0.62V	$T_c = 125^\circ C$
Maximum Reverse Leakage Current	I_R	0.05mA	Per Leg at $V_R = 60V$ $T_c = 25^\circ C$
		10mA	$T_c = 125^\circ C$
Typical Thermal Resistance, Junction to Case	$R_{\theta(j-c)}$	2.2 °C/W	Per Leg TO-220AB
		4.5 °C/W	ITO-220AB



KERSEMI

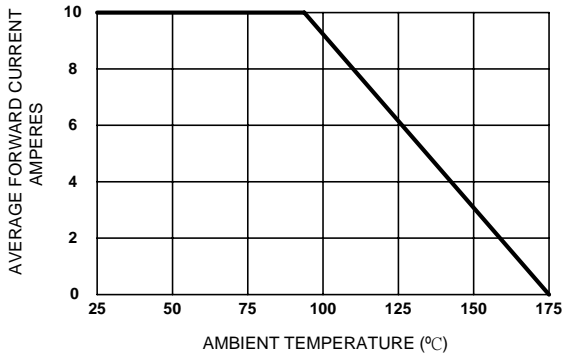

Figure 1. Forward Current Derating Curve

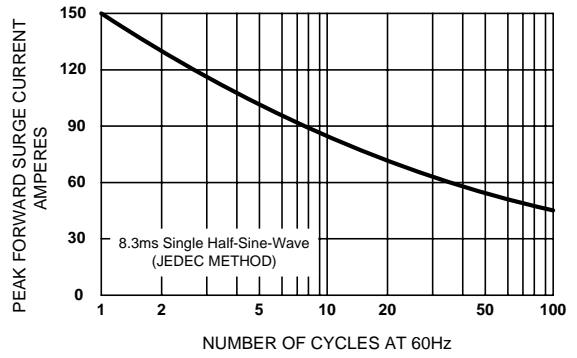

Figure 2. Maximum Non-repetitive Surge Current

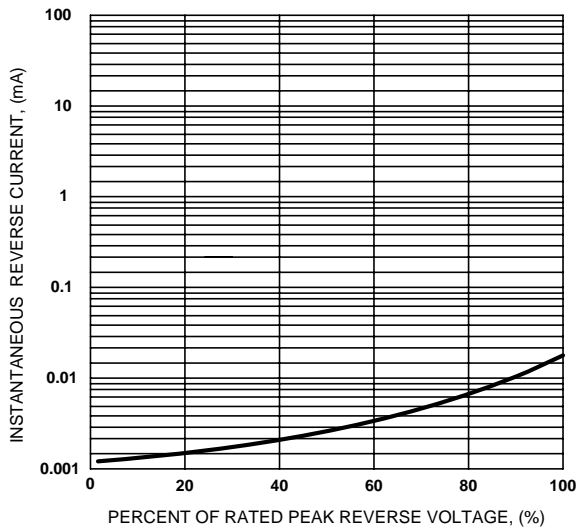

Figure 3. Typical Reverse Characteristics

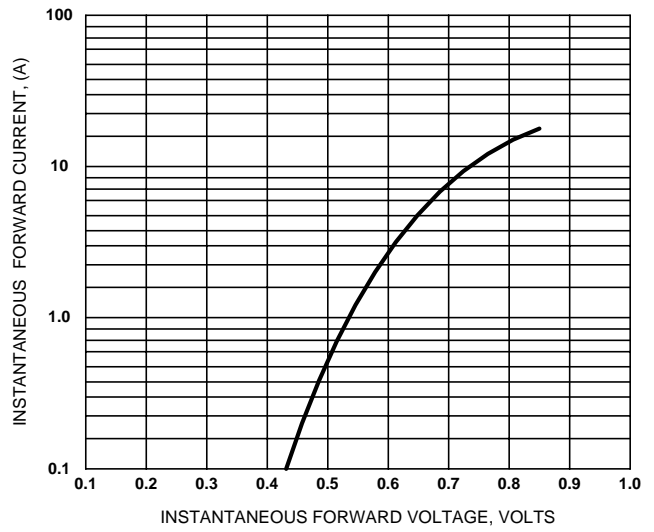

Figure 4. Typical Forward Characteristics

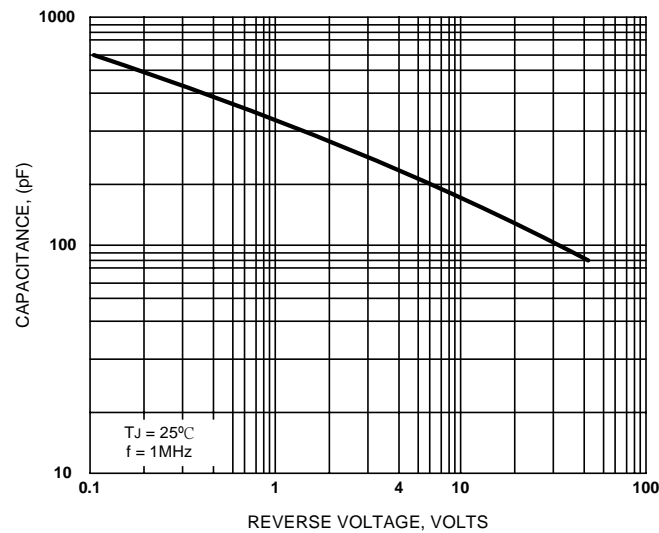

Figure 5. Typical Junction Capacitance



KERSEMI

MBR20B60CTH

TO-220AB

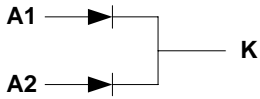
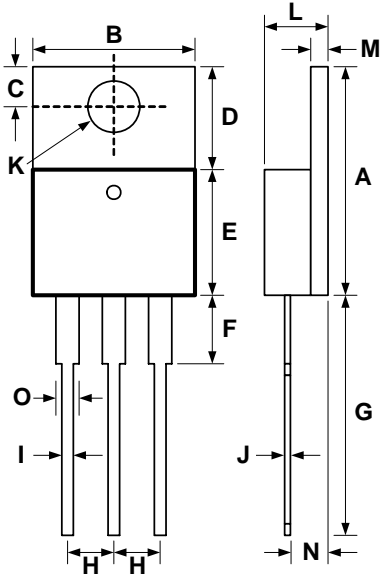

DIMENSIONS					
DIM	INCHES		MM		NOTE
	MIN	MAX	MIN	MAX	
A	.579	.606	14.70	15.40	
B	.392	.411	9.95	10.45	
C	.114	.126	2.90	3.20	
D	.248	.272	6.30	6.90	
E	.325	.350	8.25	8.90	
F	.153	.173	3.90	4.40	
G	.492	.551	12.50	14.00	
H	.096	.108	2.45	2.75	
I	.028	.039	0.70	1.00	
J	.010	.022	0.25	0.55	
K	.146	.157	3.70	4.00	
L	.167	.187	4.25	4.75	
M	.045	.057	1.15	1.45	
N	.089	.114	2.25	2.90	
O	.047	.055	1.20	1.40	

MBR20B60FCTH

ITO-220AB

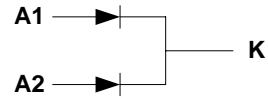
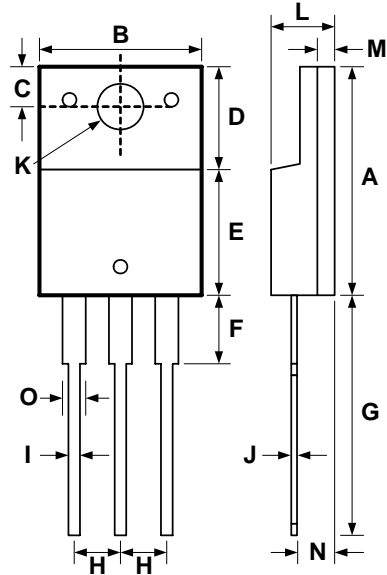

DIMENSIONS					
DIM	INCHES		MM		NOTE
	MIN	MAX	MIN	MAX	
A	.577	.600	14.65	15.25	
B	.386	.406	9.80	10.30	
C	.106	.122	2.70	3.10	
D	.258	.274	6.55	6.95	
E	.315	.331	8.00	8.40	
F	.110	.161	2.80	4.10	
G	.508	.551	12.90	14.00	
H	.089	.106	2.25	2.70	
I	.020	.028	0.50	0.70	
J	.020	.028	0.50	0.70	
K	.120	.138	3.05	3.50	
L	.169	.185	4.30	4.70	
M	.039	.051	1.00	1.30	
N	.079	.112	2.00	2.85	
O	.043	.055	1.10	1.40	