

TCL

SERVICE MANUAL

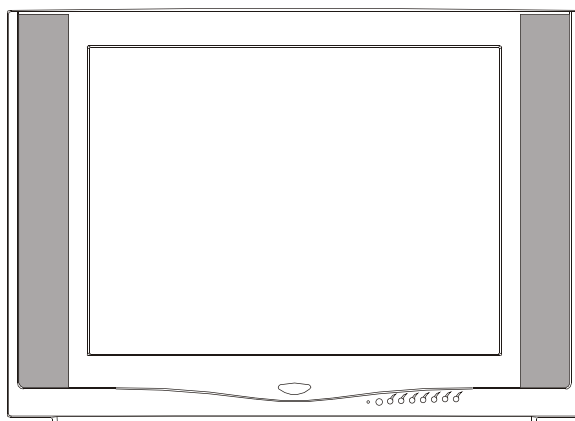

AT2127

1. Caution.....	2
2. Specification.....	6
3. BOM List.....	9
4. Alignment Procedure.....	30
5. Block Diagram.....	39
6. Schematic Diagram.....	40
7. PCB Layout.....	41
8. Exploded View Diagram.....	43

This manual is the latest at the time of printing, and does not include the modification which may be made after the printing, by the constant improvement of product.

CAUTION:

Use of controls, adjustments or procedures other than those specified herein may result in hazardous radiation exposure.



CAUTION
RISK OF ELECTRIC SHOCK DO NOT OPEN.



CAUTION: TO REDUCE THE RISK OF ELECTRICAL SHOCK, DO NOT REMOVE COVER (OR BACK). NO USER SERVICEABLE PARTS INSIDE. REFER SERVICING TO QUALIFIED SERVICE PERSONNEL.



The lightning flash with arrowhead symbol, with an equilateral triangle is intended to alert the user to the presence of uninsulated “dangerous voltage” within the product’s enclosure that may be of sufficient magnitude to constitute a risk of electric shock to the person.



The exclamation point within an equilateral triangle is intended to alert the user to the presence of important operating and maintenance (servicing) instructions in the literature accompanying the appliance.

WARNING: TO REDUCE RISK OF FIRE OR ELECTRIC SHOCK, DO NOT EXPOSE THIS APPLIANCE TO RAIN OR MOISTURE.

IMPORTANT SAFETY INSTRUCTIONS

CAUTION:

Read all of these instructions. Save these instructions for later use. Follow all Warnings and Instructions marked on the audio equipment.

1. Read Instructions- All the safety and operating instructions should be read before the product is operated.
2. Retain Instructions- The safety and operating instructions should be retained for future reference.
3. Heed Warnings- All warnings on the product and in the operating instructions should be adhered to.
4. Follow Instructions- All operating and use instructions should be followed.

FOR YOUR PERSONAL SAFETY

1. When the power cord or plug is damaged or frayed, unplug this television set from the wall outlet and refer servicing to qualified service personnel.
2. Do not overload wall outlets and extension cords as this can result in fire or electric shock.
3. Do not allow anything to rest on or roll over the power cord, and do not place the TV where power cord is subject to traffic or abuse. This may result in a shock or fire hazard.
4. Do not attempt to service this television set yourself as opening or removing covers may expose you to dangerous voltage or other hazards. Refer all servicing to qualified service personnel.
5. Never push objects of any kind into this television set through cabinet slots as they may touch dangerous voltage points or short out parts that could result in a fire or electric shock. Never spill liquid of any kind on the television set.
6. If the television set has been dropped or the cabinet has been damaged, unplug this television set from the wall outlet and refer servicing to qualified service personnel.
7. If liquid has been spilled into the television set, unplug this television set from the wall outlet and refer servicing to qualified service personnel.
8. Do not subject your television set to impact of any kind. Be particularly careful not to damage the picture tube surface.
9. Unplug this television set from the wall outlet before cleaning. Do not use liquid cleaners or aerosol cleaners. Use a damp cloth for cleaning.
- 10.1. Do not place this television set on an unstable cart, stand, or table. The television set may fall, causing serious injury to a child or an adult, and serious damage to the appliance. Use only with a cart or stand recommended by the manufacturer, or sold with the television set. Wall or shelf mounting should follow the manufacturer's instructions, and should use a mounting kit approved by the manufacturer.
- 10.2. An appliance and cart combination should be moved with care. Quick stops, excessive force, and uneven surfaces may cause the appliance and cart combination to overturn.



PROTECTION AND LOCATION OF YOUR SET

11. • Do not use this television set near water ... for example, near a bathtub, washbowl, kitchen sink, or laundry tub, in a wet basement, or near a swimming pool, etc.
 - Never expose the set to rain or water. If the set has been exposed to rain or water, unplug the set from the wall outlet and refer servicing to qualified service personnel.
12. Choose a place where light (artificial or sunlight) does not shine directly on the screen.
13. Avoid dusty places, since piling up of dust inside TV chassis may cause failure of the set when high humidity persists.
14. The set has slots, or openings in the cabinet for ventilation purposes, to provide reliable operation of the receiver, to protect it from overheating. These openings must not be blocked or covered.
 - Never cover the slots or openings with cloth or other material.
 - Never block the bottom ventilation slots of the set by placing it on a bed, sofa, rug, etc.
 - Never place the set near or over a radiator or heat register.
 - Never place the set in a "built-in" enclosure, unless proper ventilation is provided.

PROTECTION AND LOCATION OF YOUR SET

- 15.1. If an outside antenna is connected to the television set, be sure the antenna system is grounded so as to provide some protection against voltage surges and built up static charges, Section 810 of the National Electrical Code, NFPA No. 70-1975, provides information with respect to proper grounding of the mast and supporting structure, grounding of the lead-in wire to an antenna discharge unit, size of grounding conductors, location of antenna discharge unit, connection to grounding electrode, and requirements for the grounding electrode.

EXAMPLE OF ANTENNA GROUNDING AS PER NATIONAL ELECTRICAL CODE INSTRUCTIONS

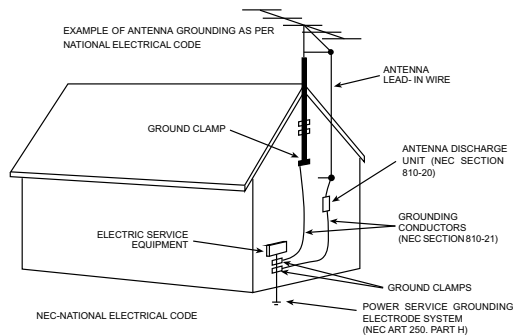

- 15.2. Note to CATV system installer : (Only for the television set with CATV reception)

This reminder is provided to call the CATV system installer's attention to Article 820-40 of the NEC that provides guidelines for proper grounding and, in particular, specifies that the cable ground shall be connected to the grounding system of the building, as close to the point of cable entry as practical.

16. An outside antenna system should not be located in the vicinity of overhead power lines or other electric lights or power circuits, or where it can fall into such power lines or circuits. When installing an outside antenna system, extreme care should be taken to keep from touching such power lines or circuits as contact with them might be fatal.
17. For added protection for this television set during a lightning storm, or when it is left unattended and unused for long periods of time, unplug it from the wall outlet and disconnect the antenna. This will prevent damage due to lightning and power-line surges.

OPERATION OF YOUR SET

18. This television set should be operated only from the type of power source indicated on the marking label. If you are not sure of the type of power supply at your home, consult your television dealer or local power company. For television sets designed to operate from battery power, refer to the operating instructions.
19. If the television set does not operate normally by following the operating instructions, unplug this television set from the wall outlet and refer servicing to qualified service personnel. Adjust only those controls that are covered in the operating instructions as improper adjustment of other controls may result in damage and will often require extensive work by a qualified technician to restore the television set to normal operation.
20. When going on a holiday : If your television set is to remain unused for a period of time, for instance, when you go on a holiday, turn the television set " off " and unplug the television set from the wall outlet.

IF THE SET DOES NOT OPERATE PROPERLY

21. If you are unable to restore normal operation by following the detailed procedure in your operating instructions, do not attempt any further adjustment. Unplug the set and call your dealer or service technician.
22. Whenever the television set is damaged or fails, or a distinct change in performance indicates a need for service, unplug the set and have it checked by a professional service technician.
23. It is normal for some TV sets to make occasional snapping or popping sounds, particularly when being turned on or off. If the snapping or popping is continuous or frequent, unplug the set and consult your dealer or service technician.

FOR SERVICE AND MODIFICATION

24. Do not use attachments not recommended by the television set manufacturer as they may cause hazards.
25. When replacement parts are required, be sure the service technician has used replacement parts specified by the manufacturer that have the same characteristics as the original part. Unauthorized substitutions may result in fire, electric shock, or other hazards.
26. Upon completion of any service or repairs to the television set, ask the service technician to perform routine safety checks to determine that the television is in safe operating condition.

PFS2 FORMAT-1 Report	
Date:2004-11-16 15:19	Product: 2127
ProductView.....:	
Report by.....:	
Specs / Products	
MasterData	
Customer Id	RADIO VICDTORIA
Version	1
Status	
Locked	
12NC	
Brand	TCL
EAN	\
UPC	\
Reception	
+Tuning - presets/channels	181, Full-Cable
+Tuning - technology	PLL
+Tuning - Indication	Full-Cable
+Freq Bands	Freq
+Channels	
+IF Freq	45.75M
+TV Systems Off Air/Cable	NTSC-M, PAL MN
+Add Systems Ext In	4.43 NTSC, 4.43PAL
+TV Systems Multi	PAL NTSC
+Sound Systems	AV STEREO
Picture - Processing	
+Scan	Standard
+Scan Modes	4:03
+Wide Screen Switching	
+Combfilter	
+Picture Control	Brightness, Color, Contrast, Tint, Sharpness Con Var, Smart pict 4 modes
+Pict Enhancement	Blue Mute
+Pict Noise Reduction	Yes
Picture - Display	
+Display Type	
+Screen Format	
+Size(Visual)" - size/vis. cm	21"
+Deflection System (CRT only)	
+Tube Technology (CRT only)	
+CRT Defl	
+CRT Gun	
+CRT Magn field	
+Resolution	
+Coating (only for D.V. sets)	
+White Point	
Sound	
+Leaflet Power	8W
+RMS Power Intern	2X4W(for 21")
+RMS Power Extern	
+Surround Sound	
+Sound Features	Mute, Smart sound(4 modes)
+Sound Control	Balance, Bass, Treble, Volume
Sound - Speakers	
+Speaker configuration	2 speakers
+Speakers used	
+Speaker Size	
User Interface	
+Interface Name	2127
+Voice Control	
+Menu	Cursor Control
+Menu Colours	
+Menu Languages	Spanish, English, Franch, Portuguese
+Special Features	V-chip with Child Lock, CCD, Favorite channel, Notebook, Biological,Calendar
+Operational Features	Alternate Channel/ recall
+PP Features	one PP for all channel

Date:2004-11-16 15:19	Product: 2127
ProductView.....: Report by.....:	
Specs / Products	
+Tuning/Install Features	Auto Cable/ Auto select. Auto channel Prog, Cable/Antenna select, Channnel Edit, Factory Mode, Language Selection, Service Mode
+Clock/Timer Functions	sleep timer
+Local Controls Front	Channel +/-, Volume+/-, Mains(Tact Switch), Menu, TV/Video
+Local Controls Top	
+Indicators - screen	
+Indicators - front	
+Numb of Loc Cont (incl Mains)	
+Number of Ind. (incl Mains)	
+Local Controls (Old)	
Remote Control	
+Remote Control - scope	TV
+Remote Control - type	Standard
+Remote Control - typenr	F
+Remote Control - features	
Connectors Rear	
+Scart RGB+Y/C+CVBS	
+Scart RGB+CVBS	
+Scart CVBS+Y/C	
+Component In (Y/U/V) Cinch	
+In Y/C+Cinch(CVBS+St)	
+In Y/C+Cinch(CVBS+Mo)	
+In Y/C+Cinch(St)	
+In BNC (CVBS)	
+In Cinch(CVBS+St)	x
+In Cinch(CVBS+Mo)	
+Out Cinch(CVBS+St)	x
+Out Cinch(CVBS+Mo)	
+Out Cinch Audio Stereo	
+Out Cinch Audio Mono	
+Out Cinch Dolby Surround	
+Dig Audio Out	
+Loudspeakers	
+Control Busses	
+Feature Slot	
+ITV Smart Port	
+Terr. Antenna in	75 Ohms(F type)
Guide + IR Blaster Jack	
Connectors Front	
+In Cinch (CVBS + St)	
+In Cinch (CVBS+Mo)	
+Headphone Out	
Connectors Side	
+In Y/C + Cinch(CVBS+St)	
+In Y/C + Cinch Stereo	
+In Cinch (CVBS + St)	x
+IN Cinch (CVBS + Mo)	
+Headphone Out	
Connectors Top	
Connectors Mechanical	
Styling	
+Cabinet Name	2127
+Configuration	
+Graphics/Logo's	TCL
+Cabinet Colour and Finish	
+Mechanics	
+Speaker Visibility	
General	
+Segment	
+Chassis	M123A
+Software Delivery Mode	
+Software Version	
+Mains Voltage	110-240V
+Mains Frequency	50Hz / 60 Hz
+Type Mains Cord	ARGENTINA

Date:2004-11-16 15:19	Product: 2127
ProductView.....: Report by.....:	
Specs / Products	
Power Consumption (P)TV in On	
Power Consumption SB in Watts	less than 3W
Power Consumption Semi SB in W	
+Power in "ON" for	
+Power in Standby for	
+Power in "OFF" for	
Weight (P)TV (incl. Packaging)	
Weight (P)TV (excl. Package)	
Weight AVUnit excl Packaging	
+INDICATION on BACKCOVER	
+Channel	
Final Equipment	
+Packaging - methods	
+Documents and manuals	
+Languages DFU	
+Cables Supplied	
+Antenna Supplied	
+Stand Supplied	
+Aux Equipm Supplied	
Packaging - width cm	
Packaging - height cm	
Packaging - depth cm	
Miscellaneous	
+EAN Indication	
+Approbation	CB
+Tests	
+Local Integration	
Various Perf. Param.	
+Service Call-Rate	
PIP/POP	
+Type	
+Features	
Digital Reception	
+Transmission	
Built-in Data System	
+Text Standard	
+(Tele)text Features	
+Nbr bckgrnd page / Mem Size	
+Text Technology	
+Digital Data handling	
+Program Guide	
Built-in Clock/Timer	
+Type	
+Features	
Built-in Radio	
+Type	
Built-in PC display	
+PC Synch	
+PC Control	
Built-in DVD drive	
+Type of Medium	
+Type of Deck	
Phased Out Items	
+Tuner/Frontend	
+Sensitivity	
+CRT EHT	
+Lightning Protection	
+Account	
+XX(Radio Antenna in)	
+Non Volatile Memory	
+In Y/C + Cinch(CVBS+Mo)	
Version of deck	

Item No.	Description	Quantity Req.	Designator	Remarks
08-002175-FRY	ASS'Y - PACKING FOR F/R CAB.	1		
74-100100-8CD	POLYBAG (100CMX100CM)	2		
74-344780-50C	EPE BOARD (900mmx400mmx5mm)	0.75		FOR REAR CABINET
76-001497-0AF	CARTON BOX LWH 640X460X360MM	0.0156		FOR OTHER PARTS
76-002111-0AR	CARTON BOX LWH 765X605X480MM	0.25		FOR R.CAB.PACKING
76-002180-1AP	CARTON BOX LWH 642X470X510MM	0.25		FOR F.CABINET
76-346740-01A	CARTON SHEET LWH 440X620X3MM	0.0179		FOR OTHER PARTS
77-100100-6WC	BUBBLE BAG (100cmX100cm)	0.5		
74-360350-50C	EPE BOARD (620mmX500mmX5mm)	0.5		
74-279070-50C	EPE BOARD (580mmX440mmX5mm)	0.25		FOR R.CAB
08-02127G-RCY	ASS'Y - REAR CABINET	1		
54-114000-00X	FELT TAPE (150mmX19mmX0.3mm)	10		STICK ON REAR CAB.
55-356640-8CN	REAR CABINET	1		
58-2127MP-JKT	PLATE MODEL NO.	1		
58-347960-8UI	INLAY REAR AV	1		
59-130460-00X	RUBBER PAD (25mmX7mm)	2		STICK ON R. CAB.(FOOTING)
62-314340-0UN	FBT SUPPORTER HIPS-KINGFA 113 (VO)	1		
62-345700-0UN	ATTACHMENT RAIL PIPS-KINGFA 113 (VO)	1		
63-B40250-AB2	S/T SCREW B 4 X 25 AB	4		MTG FRONT & REAR CAB.
63-F30100-BT3	S/T SCREW F 3 X 10 BT (BLACK)	2		MTG RCA JACK & RAER CAB.
63-W30100-AB4	S/T SCREW W 3 X 10 AB	2		MTG SUPPORTOR & REAR CAB
63-W30100-AB4	S/T SCREW W 3 X 10 AB	2		MTG M.BD TRACK & REAR CAB.
08-02175G-AVY		1		
40-2175MU-SIC	P.C.B. SIDE AV BD	1		
46-35038H-05X	HS 5P24 380 TJC3-5Y/SCN-5Y	1		P1104B P1 - P5 FOR M.BD P904
47-RCA020-XX1	RCA SOCKET Y/W/R	1	P1101	
08-0A21SG-MAY		1		
10-0FR104-FBX	DIODE FR104 (FAST RECTIFIER)	1	D402	
10-0FR104-FBX	DIODE FR104 (FAST RECTIFIER)	1	D401	
10-0FR104-FBX	DIODE FR104 (FAST RECTIFIER)	1	D403	
10-1N4001-EBX	DIODE 1N4001 (RECTIFIER)	1	D301	
10-1N4002-EBX	DIODE 1N4002 (RECTIFIER)	1	D405	
10-1N4148-ABX	DIODE 1N4148 (SWITCHING)	1	D005	
10-1N4148-ABX	DIODE 1N4148 (SWITCHING)	1	D206	
10-1N4148-ABX	DIODE 1N4148 (SWITCHING)	1	D006	

Item No.	Description	Quantity Req.	Designator	Remarks
10-1N4148-ABX	DIODE 1N4148 (SWITCHING)	1	D007	
10-1N4148-ABX	DIODE 1N4148 (SWITCHING)	1	D601	
10-1N4148-ABX	DIODE 1N4148 (SWITCHING)	1	D008	
10-1N4148-ABX	DIODE 1N4148 (SWITCHING)	1	D602	
10-1N4148-ABX	DIODE 1N4148 (SWITCHING)	1	D009	
10-1N4148-ABX	DIODE 1N4148 (SWITCHING)	1	D307	
10-1N4148-ABX	DIODE 1N4148 (SWITCHING)	1	D302	
10-1N4148-ABX	DIODE 1N4148 (SWITCHING)	1	D303	
10-1N4148-ABX	DIODE 1N4148 (SWITCHING)	1	D305	
10-CW574C-DJX	DIODE CW574CD	1	D101	
10-79C3V9-DBX	DIODE ZENER 3V9 1/2W 5%	1	D304	
10-79C5V1-DBX	DIODE ZENER 5V1 1/2W 5%	1	D001	
11-A124ES-0BX	TRANSISTOR PDTA124ES (PNP)	1	Q005	
11-C124ES-0BX	TRANSISTOR PDTC124ES (NPN)	1	Q604	
11-C124ES-0BX	TRANSISTOR PDTC124ES (NPN)	1	Q001	
11-C124ES-0BX	TRANSISTOR PDTC124ES (NPN)	1	Q004	
11-C124ES-0BX	TRANSISTOR PDTC124ES (NPN)	1	Q212	
11-C144ES-0BX	TRANSISTOR PDTC144ES (NPN)	1	Q211	
11-DD1555-0AX	TRANSISTOR 3DD1555	1	Q402	
11-SA1015-YBX	TRANSISTOR 2SA1015Y	1	Q003	
11-SA1015-YBX	TRANSISTOR 2SA1015Y	1	Q202	
11-SA1015-YBX	TRANSISTOR 2SA1015Y	1	Q605	
11-SA1015-YBX	TRANSISTOR 2SA1015Y	1	Q210	
11-SC1815-YBX	TRANSISTOR 2SC1815Y	1	Q203	
11-SC1815-YBX	TRANSISTOR 2SC1815Y	1	Q209	
11-SC1815-YBX	TRANSISTOR 2SC1815Y	1	Q002	
11-SC1815-YBX	TRANSISTOR 2SC1815Y	1	Q208	
11-SC1815-YBX	TRANSISTOR 2SC1815Y	1	Q905	
11-SC2482-0BX	TRANSISTOR 2SC2482	1	Q401	
11-SC3779-DBX	TRANSISTOR 2SC3779D (RF AMPL)	1	Q101	
13-00M24C-08P	IC EEPROM 8K M24C08 (WRITE)	1	IC001	
13-0STV93-02S	IC STV9302	1	IC301	
13-L7809C-VAP	IC L7809CV	1	IC401	
13-TDA705-7AS	IC TDA7057AQ (R/L AUDIO O/P)	1	IC601	
18-CB0100-JNX	RES. C.F. 10 OHM 1/6W +/-5%	1	J217	

Item No.	Description	Quantity Req.	Designator	Remarks
18-CB0101-JNX	RES. C.F. 100 OHM 1/6W +/-5%	1	R218	
18-CB0101-JNX	RES. C.F. 100 OHM 1/6W +/-5%	1	R009	
18-CB0101-JNX	RES. C.F. 100 OHM 1/6W +/-5%	1	R228	
18-CB0102-JNX	RES. C.F. 1K OHM 1/6W +/-5%	1	R415	
18-CB0102-JNX	RES. C.F. 1K OHM 1/6W +/-5%	1	R013	
18-CB0102-JNX	RES. C.F. 1K OHM 1/6W +/-5%	1	R234	
18-CB0102-JNX	RES. C.F. 1K OHM 1/6W +/-5%	1	R029	
18-CB0102-JNX	RES. C.F. 1K OHM 1/6W +/-5%	1	R116	
18-CB0102-JNX	RES. C.F. 1K OHM 1/6W +/-5%	1	R051	
18-CB0102-JNX	RES. C.F. 1K OHM 1/6W +/-5%	1	R901	
18-CB0102-JNX	RES. C.F. 1K OHM 1/6W +/-5%	1	R922	
18-CB0102-JNX	RES. C.F. 1K OHM 1/6W +/-5%	1	R902	
18-CB0102-JNX	RES. C.F. 1K OHM 1/6W +/-5%	1	R920	
18-CB0103-JNX	RES. C.F. 10K OHM 1/6W +/-5%	1	R012	
18-CB0103-JNX	RES. C.F. 10K OHM 1/6W +/-5%	1	R011	
18-CB0103-JNX	RES. C.F. 10K OHM 1/6W +/-5%	1	R030	
18-CB0103-JNX	RES. C.F. 10K OHM 1/6W +/-5%	1	R050	
18-CB0103-JNX	RES. C.F. 10K OHM 1/6W +/-5%	1	R043	
18-CB0103-JNX	RES. C.F. 10K OHM 1/6W +/-5%	1	R042	
18-CB0103-JNX	RES. C.F. 10K OHM 1/6W +/-5%	1	R006	
18-CB0102-JNX	RES. C.F. 1K OHM 1/6W +/-5%	1	R924	
18-CB0103-JNX	RES. C.F. 10K OHM 1/6W +/-5%	1	R047	
18-CB0103-JNX	RES. C.F. 10K OHM 1/6W +/-5%	1	R052	
18-CB0104-JNX	RES. C.F. 100K OHM 1/6W +/-5%	1	R031	
18-CB0121-JNX	RES. C.F. 120 OHM 1/6W +/-5%	1	R227	
18-CB0123-JNX	RES. C.F. 12k OHM 1/6W +/-5%	1	R212	
18-CB0151-JNX	RES. C.F. 150 OHM 1/6W +/-5%	1	R115	
18-CB0151-JNX	RES. C.F. 150 OHM 1/6W +/-5%	1	R117	
18-CB0122-JNX	RES. C.F. 1.2k OHM 1/6W +/-5%	1	R007	
18-CB0153-JNX	RES. C.F. 15k OHM 1/6W +/-5%	1	R315	
18-CB0221-JNX	RES. C.F. 220 OHM 1/6W +/-5%	1	R201	
18-CB0221-JNX	RES. C.F. 220 OHM 1/6W +/-5%	1	R202	
18-CB0221-JNX	RES. C.F. 220 OHM 1/6W +/-5%	1	R203	
18-CB0221-JNX	RES. C.F. 220 OHM 1/6W +/-5%	1	R220	
18-CB0221-JNX	RES. C.F. 220 OHM 1/6W +/-5%	1	R238	

Item No.	Description	Quantity Req.	Designator	Remarks
18-CB0221-JNX	RES. C.F. 220 OHM 1/6W +/-5%	1	R401	
18-CB0222-JNX	RES. C.F. 2.2k OHM 1/6W +/-5%	1	R055	
18-CB0222-JNX	RES. C.F. 2.2k OHM 1/6W +/-5%	1	R044	
18-CB0223-JNX	RES. C.F. 22k OHM 1/6W +/-5%	1	R215	
18-CB0223-JNX	RES. C.F. 22k OHM 1/6W +/-5%	1	R912	
18-CB0223-JNX	RES. C.F. 22k OHM 1/6W +/-5%	1	R913	
18-CB0224-JNX	RES. C.F. 220k OHM 1/6W +/-5%	1	R206	
18-CB0271-JNX	RES. C.F. 270 OHM 1/6W +/-5%	1	R217	
18-CB0271-JNX	RES. C.F. 270 OHM 1/6W +/-5%	1	R233	
18-CB0303-JNX	RES. C.F. 30K OHM 1/6W +/-5%	1	R205	
18-CB0331-JNX	RES. C.F. 330 OHM 1/6W +/-5%	1	R219	
18-CB0332-JNX	RES. C.F. 3.3k OHM 1/6W +/-5%	1	R218A	
18-CB0332-JNX	RES. C.F. 3.3k OHM 1/6W +/-5%	1	R046	
18-CB0333-JNX	RES. C.F. 33K OHM 1/6W +/-5%	1	R602	
18-CB0334-JNX	RES. C.F. 330K OHM 1/6W +/-5%	1	R232	
18-CB0392-JNX	RES. C.F. 3.9K OHM 1/6W +/-5%	1	R213	
18-CB0392-JNX	RES. C.F. 3.9K OHM 1/6W +/-5%	1	R214	
18-CB0470-JNX	RES. C.F. 47 OHM 1/6W +/-5%	1	R002	
18-CB0471-JNX	RES. C.F. 470 OHM 1/6W +/-5%	1	R119	
18-CB0471-JNX	RES. C.F. 470 OHM 1/6W +/-5%	1	R208	
18-CB0472-JNX	RES. C.F. 4.7k OHM 1/6W +/-5%	1	R015	
18-CB0472-JNX	RES. C.F. 4.7k OHM 1/6W +/-5%	1	R311	
18-CB0473-JNX	RES. C.F. 47K OHM 1/6W +/-5%	1	R216	
18-CB0473-JNX	RES. C.F. 47K OHM 1/6W +/-5%	1	R245	
18-CB0560-JNX	RES. C.F. 56 OHM 1/6W +/-5%	1	R114	
18-CB0561-JNX	RES. C.F. 560 OHM 1/6W +/-5%	1	R209	
18-CB0564-JNX	RES. C.F. 560K OHM 1/6W +/-5%	1	R210	
18-CB0681-JNX	RES. C.F. 680 OHM 1/6W +/-5%	1	R028	
18-CB0683-JNX	RES. C.F. 68K OHM 1/6W +/-5%	1	R211	
18-CB0751-JNX	RES. C.F. 750 OHM 1/6W +/-5%	1	R008	
18-CB0820-JNX	RES. C.F. 82 OHM 1/6W +/-5%	1	R903	
18-CB0820-JNX	RES. C.F. 82 OHM 1/6W +/-5%	1	R923	
18-CB0821-JNX	RES. C.F. 820 OHM 1/6W +/-5%	1	R118	
18-CB0822-JNX	RES. C.F. 8.2K OHM 1/6W +/-5%	1	R237	
18-CB0822-JNX	RES. C.F. 8.2K OHM 1/6W +/-5%	1	R606	

Item No.	Description	Quantity Req.	Designator	Remarks
18-CD0100-JNX	RES. C.F. 10 OHM 1/4W +/-5%	1	R027	
18-DB0103-FNX	RES. M.F. 10K OHM 1/6W +/-1%	1	R302	
18-DB0104-FNX	RES. M.F. 100K OHM 1/6W +/-1%	1	R303	
18-DB0153-FNX	RES. M.F. 15K OHM 1/6W +/-1%	1	R244	
18-DB0223-FNX	RES. M.F. 22K OHM 1/6W +/-1%	1	R306	
18-EF0109-JGX	RES. FUS. 1 OHM 1W +/-5% (LS)	1	R403	
18-EF0109-JGX	RES. FUS. 1 OHM 1W +/-5% (LS)	1	R405	
18-EF0109-JGX	RES. FUS. 1 OHM 1W +/-5% (LS)	1	R418	
18-EF0109-JGX	RES. FUS. 1 OHM 1W +/-5% (LS)	1	R409	
18-FF0103-JGX	RES. M.O. 10k OHM 1W +/-5%	1	R410	
18-FF0129-JGX	RES. M.O. 1.2 OHM 1W +/-5%	1	R304	
18-FF0221-JGX	RES. M.O. 220 OHM 1W +/-5%	1	R336	
18-FG0153-JHX	RES. M.O. 15k OHM 2W +/-5%	1	R404	
18-GJ0332-JUX1	RES.C.C.5W 3.3KOHM +/-5%	1	R402	
18-RG0228-JHX	RES. WIRE ROUND 0.22 OHM 2W +/-5%	1	R620	
25-BCA102-M1X	CAP. ELEC 1000 UF 16V +/-20%	1	C232	
25-BCB100-M1X	CAP. ELEC 10 UF 16V +/-20%	1	C004	
25-BCB100-M1X	CAP. ELEC 10 UF 16V +/-20%	1	C220	
25-BCB100-M1X	CAP. ELEC 10 UF 16V +/-20%	1	C023	
25-BCB100-M1X	CAP. ELEC 10 UF 16V +/-20%	1	C227	
25-BCB100-M1X	CAP. ELEC 10 UF 16V +/-20%	1	C231	
25-BCB100-M1X	CAP. ELEC 10 UF 16V +/-20%	1	C603	
25-BCB100-M1X	CAP. ELEC 10 UF 16V +/-20%	1	C901	
25-BCB100-M1X	CAP. ELEC 10 UF 16V +/-20%	1	C902	
25-BCB100-M1X	CAP. ELEC 10 UF 16V +/-20%	1	C907	
25-BCB100-M1X	CAP. ELEC 10 UF 16V +/-20%	1	C025	
25-BCB100-M1X	CAP. ELEC 10 UF 16V +/-20%	1	C311	
25-BCB101-M1X	CAP. ELEC 100 UF 16V +/-20%	1	C240	
25-BCB101-M1X	CAP. ELEC 100 UF 16V +/-20%	1	C605	
25-BCB101-M1X	CAP. ELEC 100 UF 16V +/-20%	1	C211	
25-BCB101-M1X	CAP. ELEC 100 UF 16V +/-20%	1	C101	
25-BCB101-M1X	CAP. ELEC 100 UF 16V +/-20%	1	C016	
25-BCB101-M1X	CAP. ELEC 100 UF 16V +/-20%	1	C903	
25-BCB221-M1X	CAP. ELEC 220 UF 16V +/-20%	1	C418	
25-BCB221-M1X	CAP. ELEC 220 UF 16V +/-20%	1	C906	

Item No.	Description	Quantity Req.	Designator	Remarks
25-BCB470-M1X	CAP. ELEC 47 UF 16V +/-20%	1	C423	
25-BCB470-M1X	CAP. ELEC 47 UF 16V +/-20%	1	C202	
25-BCB470-M1X	CAP. ELEC 47 UF 16V +/-20%	1	C082	
25-BDA471-M1X	CAP. ELEC 470 UF 25V +/-20%	1	C217	
25-BDA471-M1X	CAP. ELEC 470 UF 25V +/-20%	1	C604	
25-BDA471-M1X	CAP. ELEC 470 UF 25V +/-20%	1	C415	
25-BDB221-M1X	CAP. ELEC 220 UF 25V +/-20%	1	C301	
25-BEA102-M1X	CAP. ELEC 1000 UF 35V +/-20%	1	C413	
25-BEB101-M1X	CAP. ELEC 100 UF 35V +/-20%	1	C302	
25-BFB109-M1X	CAP. ELEC 1 UF 50V +/-20%	1	C208	
25-BFB109-M1X	CAP. ELEC 1 UF 50V +/-20%	1	C915	
25-BFB109-M1X	CAP. ELEC 1 UF 50V +/-20%	1	C916	
25-BFB109-M1X	CAP. ELEC 1 UF 50V +/-20%	1	C203	
25-BFB109-M1X	CAP. ELEC 1 UF 50V +/-20%	1	C008A	
25-BFB109-M1X	CAP. ELEC 1 UF 50V +/-20%	1	C214	
25-BFB220-M1X	CAP. ELEC 22 UF 50V +/-20%	1	C106	
25-BFB478-M1X	CAP. ELEC 0.47 UF 50V +/-20%	1	C218	
25-BFB479-M1X	CAP. ELEC 4.7 UF 50V +/-20%	1	C304	
25-BFB479-M1X	CAP. ELEC 4.7 UF 50V +/-20%	1	C216	
25-BFB479-M1X	CAP. ELEC 4.7 UF 50V +/-20%	1	C104	
25-BFB479-M1X	CAP. ELEC 4.7 UF 50V +/-20%	1	C310	
25-BHB100-M1X	CAP. ELEC 10 UF 100V +/-20%	1	C420	
25-BJA470-M1X	CAP. ELEC 47 UF 160V +/-20%	1	C411	
25-BLA100-M1X	CAP. ELEC 10 UF 250V +/-20%	1	C408	
25-GFB228-K1X	CAP. ELEC 0.22 UF 50V +/-10%	1	C205	
25-GFB478-K1X	CAP. ELEC 0.47 UF 50V +/-10%	1	C234	
25-GFB478-K1X	CAP. ELEC 0.47 UF 50V +/-10%	1	C236	
26-AIC102-KBX	CAP. CER 1000 PF 500V +/-10% B	1	C401	
26-AIC102-KBX	CAP. CER 1000 PF 500V +/-10% B	1	C404	
26-AIC391-KBX	CAP. CER 390 PF 500V +/-10% B	1	C409	
26-EBP102-KBX	CAP. CER 1000 PF 50V +/-10% B	1	C112	
26-EBP102-KBX	CAP. CER 1000 PF 50V +/-10% B	1	C219	
26-EBP103-ZFX	CAP. CER 0.01UF 50V +80/-20% F	1	C212	
26-EBP103-ZFX	CAP. CER 0.01UF 50V +80/-20% F	1	C102	
26-EBP103-ZFX	CAP. CER 0.01UF 50V +80/-20% F	1	C019	

Item No.	Description	Quantity Req.	Designator	Remarks
26-EBP103-ZFX	CAP. CER 0.01UF 50V +80/-20% F	1	C114	
26-EBP103-ZFX	CAP. CER 0.01UF 50V +80/-20% F	1	C024	
26-EBP103-ZFX	CAP. CER 0.01UF 50V +80/-20% F	1	C201	
26-EBP103-ZFX	CAP. CER 0.01UF 50V +80/-20% F	1	C241	
26-EBP103-ZFX	CAP. CER 0.01UF 50V +80/-20% F	1	C005	
26-EBP103-ZFX	CAP. CER 0.01UF 50V +80/-20% F	1	C228	
26-EBP103-ZFX	CAP. CER 0.01UF 50V +80/-20% F	1	C230	
26-EBP103-ZFX	CAP. CER 0.01UF 50V +80/-20% F	1	C233	
26-EBP103-ZFX	CAP. CER 0.01UF 50V +80/-20% F	1	C425	
26-EBP103-ZFX	CAP. CER 0.01UF 50V +80/-20% F	1	C417	
26-EBP103-ZFX	CAP. CER 0.01UF 50V +80/-20% F	1	C110	
26-EBP103-ZFX	CAP. CER 0.01UF 50V +80/-20% F	1	C239	
26-EBP103-ZFX	CAP. CER 0.01UF 50V +80/-20% F	1	C020	
26-EBP103-ZFX	CAP. CER 0.01UF 50V +80/-20% F	1	C017	
26-EBP103-ZFX	CAP. CER 0.01UF 50V +80/-20% F	1	C221	
26-EBP103-ZFX	CAP. CER 0.01UF 50V +80/-20% F	1	C081	
26-EBP103-ZFX	CAP. CER 0.01UF 50V +80/-20% F	1	C105	
26-EBP152-KBX	CAP. CER 1500pF 50V +/-10% B	1	C209	
26-EBP181-JCX	CAP. CER 180PF 50V +/-5% CH	1	C207	
26-EBP270-JCX	CAP. CER 27PF 50V +/-5% CH	1	C011	
26-EBP272-KBX	CAP. CER 2700pF 50V +/-10% B	1	C210	
26-EBP331-JCX	CAP. CER 330PF 50V +/-5% CH	1	C018	
26-EBP391-JCX	CAP. CER. 390PF 50V +/-5% CH	1	C403	
26-EBP391-JCX	CAP. CER. 390PF 50V +/-5% CH	1	C412	
27-AGQ563-J0X	CAP. M.PP 0.056 UF 250V +/-5%	1	C410	
27-MBC104-J0X	CAP. M.P.E 0.1 UF 63V +/-5%	1	C909	
27-MBC104-J0X	CAP. M.P.E 0.1 UF 63V +/-5%	1	C610	
27-MBC104-J0X	CAP. M.P.E 0.1 UF 63V +/-5%	1	C309	
27-MBC104-J0X	CAP. M.P.E 0.1 UF 63V +/-5%	1	C242	
27-MBC224-J0X	CAP. M.P.E 0.22UF 63V +/-5%	1	C305	
27-MBC474-J0X	CAP. M.P.E 0.47UF 63V +/-5%	1	C601	
27-MBC474-J0X	CAP. M.P.E 0.47UF 63V +/-5%	1	C602	
27-PBC222-J0X	CAP. P.E 0.0022UF 63V +/-5%	1	C213	
27-PBC222-J0X	CAP. P.E 0.0022UF 63V +/-5%	1	C204	
27-PBC822-J0X	CAP. P.E 0.0082UF 63V +/-5%	1	C235	

Item No.	Description	Quantity Req.	Designator	Remarks
34-A109K0-1IX	COIL CHOKE 1 UH +/-10%	1	L103	
34-A109K0-1IX	COIL CHOKE 1 UH +/-10%	1	L102	
34-R100J2-0EX	COIL PL - 10 UH +/-5%	1	L002	
34-R220J2-0EX	COIL PL - 22 UH +/-5%	1	L208	
34-R220J2-0EX	COIL PL - 22 UH +/-5%	1	L207	
34-R330J2-0EX	COIL PL - 33 UH +/-5%	1	L080	
34-R330J2-0EX	COIL PL - 33 UH +/-5%	1	L202	
34-R829J2-0EX	COIL PL - 8.2 UH +/-5%	1	L204	
36-HDR001-AX1	TRANSFOR HOR. DRIVE (MAGNETIC CORE)	1	T401	
41-WJ0050-B00	WIRE BARE JUMPER 5MM	1	L101	
41-WJ0060-B00	WIRE BARE JUMPER 6mm	1	J009A	
41-WJ0060-B00	WIRE BARE JUMPER 6mm	1	J015	
41-WJ0060-B00	WIRE BARE JUMPER 6mm	1	J101	
41-WJ0060-B00	WIRE BARE JUMPER 6mm	1	J203	
41-WJ0060-B00	WIRE BARE JUMPER 6mm	1	J210	
41-WJ0060-B00	WIRE BARE JUMPER 6mm	1	J211	
41-WJ0060-B00	WIRE BARE JUMPER 6mm	1	R204	
41-WJ0060-B00	WIRE BARE JUMPER 6mm	1	R207	
41-WJ0060-B00	WIRE BARE JUMPER 6mm	1	R249	
41-WJ0060-B00	WIRE BARE JUMPER 6mm	1	J001	
41-WJ0060-B00	WIRE BARE JUMPER 6mm	1	R200	
41-WJ0060-B00	WIRE BARE JUMPER 6mm	1	J907	
41-WJ0065-B00	WIRE BARE JUMPER 6.5MM	1	J010	
41-WJ0065-B00	WIRE BARE JUMPER 6.5MM	1	J208	
41-WJ0065-B00	WIRE BARE JUMPER 6.5MM	1	J301	
41-WJ0070-B00	WIRE BARE JUMPER 7MM	1	J217A	
41-WJ0070-B00	WIRE BARE JUMPER 7MM	1	J011	
41-WJ0070-B00	WIRE BARE JUMPER 7MM	1	J012	
41-WJ0075-B00	WIRE BARE JUMPER 7.5MM	1	J018	
41-WJ0075-B00	WIRE BARE JUMPER 7.5MM	1	J218	
41-WJ0075-B00	WIRE BARE JUMPER 7.5MM	1	J215	
41-WJ0075-B00	WIRE BARE JUMPER 7.5MM	1	J602	
41-WJ0075-B00	WIRE BARE JUMPER 7.5MM	1	J303	
41-WJ0075-B00	WIRE BARE JUMPER 7.5MM	1	J022	
41-WJ0075-B00	WIRE BARE JUMPER 7.5MM	1	J913	

Item No.	Description	Quantity Req.	Designator	Remarks
41-WJ0075-B00	WIRE BARE JUMPER 7.5MM	1	J225	
41-WJ0075-B00	WIRE BARE JUMPER 7.5MM	1	J914	
41-WJ0075-B00	WIRE BARE JUMPER 7.5MM	1	J901	
41-WJ0080-B00	WIRE BARE JUMPER 8 MM	1	J108	
41-WJ0080-B00	WIRE BARE JUMPER 8 MM	1	J903	
41-WJ0080-B00	WIRE BARE JUMPER 8 MM	1	J919	
41-WJ0085-B00	WIRE BARE JUMPER 8.5MM	1	J219	
41-WJ0085-B00	WIRE BARE JUMPER 8.5MM	1	J209	
41-WJ0085-B00	WIRE BARE JUMPER 8.5MM	1	J302	
41-WJ0085-B00	WIRE BARE JUMPER 8.5MM	1	J306	
41-WJ0085-B00	WIRE BARE JUMPER 8.5MM	1	J920	
41-WJ0090-B00	WIRE BARE JUMPER 9MM	1	J212	
41-WJ0090-B00	WIRE BARE JUMPER 9MM	1	J904	
41-WJ0095-B00	WIRE BARE JUMPER 9.5MM	1	J230	
41-WJ0095-B00	WIRE BARE JUMPER 9.5MM	1	J601	
41-WJ0095-B00	WIRE BARE JUMPER 9.5MM	1	J231	
41-WJ0095-B00	WIRE BARE JUMPER 9.5MM	1	J229	
41-WJ0100-B00	WIRE BARE JUMPER 10MM	1	J102	
41-WJ0100-B00	WIRE BARE JUMPER 10MM	1	J221	
41-WJ0100-B00	WIRE BARE JUMPER 10MM	1	J002	
41-WJ0100-B00	WIRE BARE JUMPER 10MM	1	J002A	
41-WJ0100-B00	WIRE BARE JUMPER 10MM	1	J003	
41-WJ0100-B00	WIRE BARE JUMPER 10MM	1	J402	
41-WJ0100-B00	WIRE BARE JUMPER 10MM	1	J110	
41-WJ0100-B00	WIRE BARE JUMPER 10MM	1	J917	
41-WJ0100-B00	WIRE BARE JUMPER 10MM	1	J111	
41-WJ0100-B00	WIRE BARE JUMPER 10MM	1	J017	
41-WJ0100-B00	WIRE BARE JUMPER 10MM	1	J910	
41-WJ0100-B00	WIRE BARE JUMPER 10MM	1	J911	
41-WJ0105-B00	WIRE BARE JUMPER 10.5MM	1	J304	
41-WJ0110-B00	WIRE BARE JUMPER 11MM	1	J016	
41-WJ0110-B00	WIRE BARE JUMPER 11MM	1	J226	
41-WJ0115-B00	WIRE BARE JUMPER 11.5MM	1	J604	
41-WJ0125-B00	WIRE BARE JUMPER 12.5MM	1	J106	
41-WJ0125-B00	WIRE BARE JUMPER 12.5MM	1	R317	

Item No.	Description	Quantity Req.	Designator	Remarks
41-WJ0125-B00	WIRE BARE JUMPER 12.5MM	1	J216	
41-WJ0130-B00	WIRE BARE JUMPER 13MM	1	J204	
41-WJ0130-B00	WIRE BARE JUMPER 13MM	1	J006	
41-WJ0135-B00	WIRE BARE JUMPER 13.5MM	1	J014	
41-WJ0140-B00	WIRE BARE JUMPER 14MM	1	J005	
41-WJ0160-B00	WIRE BARE JUMPER 16MM	1	J105	
41-WJ0165-B00	WIRE BARE JUMPER 16.5MM	1	J220	
41-WJ0165-B00	WIRE BARE JUMPER 16.5MM	1	J013	
41-WJ0170-B00	WIRE BARE JUMPER 17MM	1	J401	
41-WJ0175-B00	WIRE BARE JUMPER 17.5MM	1	R045	
41-WJ0195-B00	WIRE BARE JUMPER 19.5MM	1	J003A	
41-WJ0200-B00	WIRE BARE JUMPER 20MM	1	J233	
45-OSC8M0-0Y0	CRYSTAL 8.0MHZ	1	X001	
45-TRA4M5-0Y0	CER TRAP TPS 4.5MHZ	1	X201	
46-12866W-02X	PIN BASE *2 S11-02Y	1		P601 FOR FRONT CAB.(SPK)
46-20598W-04X	PIN BASE *4 TJC1-4A	1		P401 FOR DY CONNECTER
46-33079W-02X	PIN BASE *2 TJC3-2A	1		P602 FOR FRONT CAB.(SPK)
46-33079W-05X	PIN BASE *5 TJC3-5A	1		P201 FOR CRT BD P503
46-35179W-04X	PIN BASE TJC3-4A	1		P402 FOR CRT BD P502
57-10654X-00F	cable ties□(2.5mmX95mm)	3		
64-P30060-104	M/C SCREW 3 X 6 (ZINC)	2		FOR IC401 & IC402
64-P30100-104	M/C SCREW P 3 X 10	2		FOR IC601
64-P30100-104	M/C SCREW P 3 X 10	2		FOR Q402 & IC301
65-Z30050-23M	NUT M 3	2		FOR Q402 & IC301
66-343730-0B0	HOLLOW RIVET 1.6X3.0XL3.2	2		FOR L411
66-343730-0B0	HOLLOW RIVET 1.6X3.0XL3.2	3		FOR Q402
66-343730-0B0	HOLLOW RIVET 1.6X3.0XL3.2	9		FOR T402
66-343730-0B0	HOLLOW RIVET 1.6X3.0XL3.2	2		FOR L412
66-343730-0B0	HOLLOW RIVET 1.6X3.0XL3.2	4		FOR C421,C406B
67-H24249-2M2	HEAT SINK	1		FOR IC402
67-H24249-3M2	HEAT SINK	1		FOR IC401
67-H30752-3A0	HEAT SINK	2		FOR IC301 & Q402
67-H34423-EA0	HEAT SINK	1		FOR IC601
18-CD0101-JNX	RES. C.F. 100 OHM 1/4W +/-5%	1	R621	
62-227680-0UA	BRACKET ABS-KINGFA 606 (UO)	1		

Item No.	Description	Quantity Req.	Designator	Remarks
27-RCP333-J0X	CAP. PP 0.033 UF 100V +/-5%	1	C405	
13-L7805C-VAP	IC L7805CV 1.5A (REGULATOR)	1	IC402	
27-MBC103-J0X	CAP. M.P.E 0.01UF 63V +/-5%	1	C215	
27-PBC472-J0X	CAP. P.E 0.0047UF 63V +/-5%	1	C607	
27-PBC472-J0X	CAP. P.E 0.0047UF 63V +/-5%	1	C608	
18-CB0220-JNX	RES. C.F. 22 OHM 1/6W +/-5%	1	R001	
18-CB0220-JNX	RES. C.F. 22 OHM 1/6W +/-5%	1	R005	
18-CB0472-JNX	RES. C.F. 4.7k OHM 1/6W +/-5%	1	R003	
18-CB0472-JNX	RES. C.F. 4.7k OHM 1/6W +/-5%	1	R004	
34-A220K0-1IX	COIL PL - 22UH +/-10% LGA0305-220K	1	L201	
66-343740-0B0	HOLLOW RIVET (2.3mmx4.0mmx3.5mm)	2		FOR R402
41-WJ0055-B00	WIRE BARE JUMPER 5.5 MM	1	J922	
46-33079W-03X	PIN BASE *3 TJC3-3A	1	P001	
18-FF0102-JGX	RES. M.O. 1k OHM 1W +/-5%	1	R408	
27-PBC472-J0X	CAP. P.E 0.0047UF 63V +/-5%	1	C422	
10-0FR104-FBX	DIODE FR104 (FAST RECTIFIER)	1	D404	
18-FF0123-JGX	RES. M.O. 12k OHM 1W +/-5%	1	R406	
18-CB0103-JNX	RES. C.F. 10K OHM 1/6W +/-5%	1	J305	
40-2111SG-MA11X	P.C.B. MAIN PCB BD	1		
41-WJ0105-B00	WIRE BARE JUMPER 10.5MM	1	R406A	
41-WJ0085-B00	WIRE BARE JUMPER 8.5MM	1	J205	
41-WJ0085-B00	WIRE BARE JUMPER 8.5MM	1	J206	
25-BCB101-M1X	CAP. ELEC 100 UF 16V +/-20%	1	C900	
10-79C8V2-DBX	DIODE ZENER 8V2 1/2W 5%	1	D406	
26-EBP470-JZX	CAP. CER 47PF 50V +/-5% SL	1	C424	
26-EBP222-KBX	CAP. CER 2200PF 50V +/-10% B	1	C014	
41-WJ0150-B00	WIRE BARE JUMPER 15MM	1	L402	
41-WJ0070-B00	WIRE BARE JUMPER 7MM	1	J223	
26-EBP101-JZX	CAP. CER 100pF 50V +/-5% SL	1	C001	
26-EBP101-JZX	CAP. CER 100pF 50V +/-5% SL	1	C002	
26-EBP390-JZX	CAP. CER 39 pF 50V +/-5%	1	C021	
26-EBP390-JZX	CAP. CER 39 pF 50V +/-5%	1	C022	
08-0A21SG-PWY		1		
10-0FR104-FBX	DIODE FR104 (FAST RECTIFIER)	1	D833	
10-0FR104-FBX	DIODE FR104 (FAST RECTIFIER)	1	D802	

Item No.	Description	Quantity Req.	Designator	Remarks
10-ORL255-EBX	DIODE RL255 (POWER RECTIFIER)	1	D815	
10-ORL255-EBX	DIODE RL255 (POWER RECTIFIER)	1	D816	
10-ORL255-EBX	DIODE RL255 (POWER RECTIFIER)	1	D817	
10-ORL255-EBX	DIODE RL255 (POWER RECTIFIER)	1	D818	
10-ORU3YX-F0X	DIODE RU3YX (FAST RECTIFIER)	1	D830	
10-1N4148-ABX	DIODE 1N4148 (SWITCHING)	1	D805	
10-1SS136-ABX	DIODE 1SS136	1	D804	
10-1SS136-ABX	DIODE 1SS136	1	D835	
10-79C8V2-DBX	DIODE ZENER 8V2 1/2W 5%	1	D839	
10-HER108-FBX	DIODE HER108	1	D806	
10-HS16VC-DBX	DIODE 500mW 16HSC	1	D838	
10-HS6V2B-DBX	DIODE 6V2 500mW	1	D840	
11-SC1815-YBX	TRANSISTOR 2SC1815Y	1	Q832	
11-SC1815-YBX	TRANSISTOR 2SC1815Y	1	Q831	
11-SC2688-LAX	TRANSISTOR 2SC2688L (NPN)	1	Q830	
11-SK2996-0AX	TRANSISTOR 2SK2996 (MOS)	1	Q801	
13-0HPC92-2CP	PHOTO COUPLER HPC922-C	1	IC802	
13-44608P-40P	IC MC44608P40	1	IC801	
18-CB0102-JNX	RES. C.F. 1K OHM 1/6W +/-5%	1	R809	
18-CB0183-JNX	RES. C.F. 18k OHM 1/6W +/-5%	1	R838	
18-CB0332-JNX	RES. C.F. 3.3k OHM 1/6W +/-5%	1	R834	
18-CB0392-JNX	RES. C.F. 3.9K OHM 1/6W +/-5%	1	R807	
18-CB0472-JNX	RES. C.F. 4.7k OHM 1/6W +/-5%	1	R806	
18-CB0682-JNX	RES. C.F. 6.8K OHM 1/6W +/-5%	1	R850	
18-CD0220-JNX	RES. C.F. 22 OHM 1/4W +/-5%	1	R811A	
18-CD0221-JNX	RES. C.F. 220 OHM 1/4W +/-5%	1	R833	
18-CD0392-JNX	RES. C.F. 3.9K OHM 1/4W +/-5%	1	R835	
18-CD0471-JNX	RES. C.F. 470 OHM 1/4W +/-5%	1	R811	
18-CE0479-JNX	RES. C.F. 4.7 OHM 1/2W +/-5%	1	R832	
18-CE0563-JNX	RES. C.F. 56k OHM 1/2W +/-5%	1	R831	
18-DD0104-FNX	RES. M.F. 0.1M OHM 1/4W +/-1%	1	R804	
18-DD0912-FNX	RES. M.F. 9.1K OHM 1/4W +/-1%	1	R804A	
18-FG0333-JHX	RES. M.O. 33K OHM 2W +/-5%	1	R837	
18-GJ0103-KUX1	RES.C.C.5W 10KOHM +/-10%	1	R836	
18-GJ0223-KUX1	RES.C.C.5W 22KOHM +/-10	1	R808	

Item No.	Description	Quantity Req.	Designator	Remarks
18-KE0105-JN3	RES. H.VOLT. CC 1M OHM 1/2W +/-5%	1	R802	
18-KF0825-JH3	RES. H.VOLT.CC 8.2M OHM 1W +/-5%	1	R812	
18-RG0228-JHX	RES. WIRE ROUND 0.22 OHM 2W +/-5%	1	R810	
20-TR103H-5CX	TRIMMER B10K HORIZ TYPE	1	VR830	
22-NTC479-XX0	NTC 4.7 OHM +/-18% NTC4.7D2-14	1	RT802	
22-PTC200-XX1	PTC 20 OHM +/-20%	1	RT801	
25-343260-M1X	CAR. ELEC	1	C832	
25-BCA102-M1X	CAP. ELEC 1000 UF 16V +/-20%	1	C849	
25-BCB100-M1X	CAP. ELEC 10 UF 16V +/-20%	1	C812	
25-BCB470-M1X	CAP. ELEC 47 UF 16V +/-20%	1	C845	
25-BJG101-M1X	CAP. ELEC 100 UF 160V +/-20%	1	C835	
25-BMJ221-M1X	CAP. ELEC 220 UF 400V +/-20%	1	C806	
26-ABC101-JZX	CAP. CER 100 PF 50V +/-5% SL	1	C814	
26-ABC104-ZFX	CAP. CER 0.1 UF 50V +80-20% F	1	C813	
26-ABC104-ZFX	CAP. CER 0.1 UF 50V +80-20% F	1	C831	
26-ABC104-ZFX	CAP. CER 0.1 UF 50V +80-20% F	1	C842	
26-ABC221-JZX	CAP. CER 220 PF 50V +/-5% SL	1	C841	
26-ABC471-JZX	CAP. CER 470 PF 50V +/-5% SL	1	C851	
26-AGK221-KRX	CAP. CER 220 PF 250V +/-10%	1	C830	
26-AIM103-KBX	CAP. CER 0.01UF 500V +/-10% B	1	C834	
26-AIM103-KBX	CAP. CER 0.01UF 500V +/-10% B	1	C805	
26-AMK102-KRX	CAP. CER 1000 pF 2KV +/-10% R	1	C815	
26-APK222-ME4	CAP. CER 2200PF 400VAC+/-20% E	1	C816	
26-APK471-KBX	CAP. CER 470PF 400VAC +/-10% B	1	C803	
26-APK471-KBX	CAP. CER 470PF 400VAC +/-10% B	1	C804	
26-AQK472-ZFX	CAP. CER 4700PF 250VAC+80-20%F	1	C807	
26-AQK472-ZFX	CAP. CER 4700PF 250VAC+80-20%F	1	C808	
26-EBP102-KBX	CAP. CER 1000 PF 50V +/-10% B	1	C848	
26-EBP102-KBX	CAP. CER 1000 PF 50V +/-10% B	1	C804A	
26-EBP103-ZFX	CAP. CER 0.01UF 50V +80/-20% F	1	C844	
27-AQT224-MVH	CAP. M.PP 0.22 UF 275VAC 20%	1	C801	
27-MBC104-J0X	CAP. M.P.E 0.1 UF 63V +/-5%	1	C850	
27-RJP472-J0X	CAP. PP 4700 PF 630V +/-5%	1	C809	
34-R100K2-1BX	COIL CHOKE 10 UH +/-10%	1	L843	
34-R101K2-1BX	COIL CHOKE 100 UH +/-10%	1	L804	

Item No.	Description	Quantity Req.	Designator	Remarks
35-139730-00X	FERR. BEAD BF60	2		FOR D830
35-139730-00X	FERR. BEAD BF60	2		FOR D806
35-139730-00X	FERR. BEAD BF60	2		FOR D831
35-139730-00X	FERR. BEAD BF60	2		FOR D833
36-TRF110-XX0	TRANSFORMER	1	T803	
41-WJ0075-B00	WIRE BARE JUMPER 7.5MM	1	J809	
41-WJ0075-B00	WIRE BARE JUMPER 7.5MM	1	D838A	
41-WJ0075-B00	WIRE BARE JUMPER 7.5MM	1	J821	
41-WJ0085-B00	WIRE BARE JUMPER 8.5MM	1	J812	
41-WJ0090-B00	WIRE BARE JUMPER 9MM	1	J805	
41-WJ0100-B00	WIRE BARE JUMPER 10MM	1	J820	
41-WJ0100-B00	WIRE BARE JUMPER 10MM	1	J822	
41-WJ0100-B00	WIRE BARE JUMPER 10MM	1	R807A	
41-WJ0105-B00	WIRE BARE JUMPER 10.5MM	1	J824	
41-WJ0115-B00	WIRE BARE JUMPER 11.5MM	1	J832	
41-WJ0120-B00	WIRE BARE JUMPER 12MM	1	J823	
41-WJ0125-B00	WIRE BARE JUMPER 12.5MM	1	J804	
41-WJ0135-B00	WIRE BARE JUMPER 13.5MM	1	J833	
41-WJ0150-B00	WIRE BARE JUMPER 15MM	1	J826	
41-WJ0150-B00	WIRE BARE JUMPER 15MM	1	J802	
41-WJ0160-B00	WIRE BARE JUMPER 16MM	1	J825	
41-WJ0165-B00	WIRE BARE JUMPER 16.5MM	1	J831	
41-WJ0175-B00	WIRE BARE JUMPER 17.5MM	1	J807	
41-WJ0190-B00	WIRE BARE JUMPER 19MM	1	J811	
41-WJ0195-B00	WIRE BARE JUMPER 19.5MM	1	J828	
41-WJ0195-B00	WIRE BARE JUMPER 19.5MM	1	J829	
41-WJ0200-B00	WIRE BARE JUMPER 20MM	1	J830	
46-10962W-02X	PIN BASE *2 TJC2-2A	1	P801	
64-B30100-104	M/C SCREW B 3 X 10	1		FOR Q801
66-20516X-0B0	FUSE HOLDER	2		FOR FUSE
66-343730-0B0	HOLLOW RIVET 1.6X3.0XL3.2	4		FOR T803
66-343730-0B0	HOLLOW RIVET 1.6X3.0XL3.2	4		FOR T801
66-343730-0B0	HOLLOW RIVET 1.6X3.0XL3.2	3		FOR RT801
66-343730-0B0	HOLLOW RIVET 1.6X3.0XL3.2	10		FOR C835,C801,L804,D831,D830
67-H35984-5A0	HEAT SINK	1		FOR Q801

Item No.	Description	Quantity Req.	Designator	Remarks
71-DYP000-WX1	LABEL	1		STICK ON HEAT SINK
10-00RU3C-F0X	DIODE RU3C (FAST RECTIFIER)	1	D831	
36-LIF022-AX0	LINE FILTER	1	T801	
41-WJ0050-B00	WIRE BARE JUMPER 5MM	1	R820	
41-WJ0050-B00	WIRE BARE JUMPER 5MM	1	R821	
41-WJ0050-B00	WIRE BARE JUMPER 5MM	1	R822	
25-BDA102-M1X	CAP. ELEC 1000 UF 25V +/-20%	1	C843	
66-343740-0B0	HOLLOW RIVET (2.3mmx4.0mmx3.5mm)	8		FOR R808,R836,C806,P801
26-AKK221-KRX	CAP. CER 220 PF 1KV +/-10% R	1	C833	
27-MBC104-J0X	CAP. M.P.E 0.1 UF 63V +/-5%	1		并在R838上
41-WJ0100-B00	WIRE BARE JUMPER 10MM	1	R851	
18-CB0183-JNX	RES. C.F. 18k OHM 1/6W +/-5%	1	R844	
08-0D276G-CRY	ASS'Y- CRT BD	1		
10-1N4148-ABX	DIODE 1N4148 (SWITCHING)	1	D502	
10-1N4148-ABX	DIODE 1N4148 (SWITCHING)	1	D501	
11-SA1015-YBX	TRANSISTOR 2SA1015Y	1	Q510	
11-SC2482-0BX	TRANSISTOR 2SC2482	1	Q501	
11-SC2482-0BX	TRANSISTOR 2SC2482	1	Q502	
11-SC2482-0BX	TRANSISTOR 2SC2482	1	Q503	
18-CB0101-JNX	RES. C.F. 100 OHM 1/6W +/-5%	1	R501	
18-CB0101-JNX	RES. C.F. 100 OHM 1/6W +/-5%	1	R504	
18-CB0101-JNX	RES. C.F. 100 OHM 1/6W +/-5%	1	R507	
18-CB0102-JNX	RES. C.F. 1K OHM 1/6W +/-5%	1	R522	
18-CB0222-JNX	RES. C.F. 2.2k OHM 1/6W +/-5%	1	R524	
18-CB0471-JNX	RES. C.F. 470 OHM 1/6W +/-5%	1	R525	
18-CB0471-JNX	RES. C.F. 470 OHM 1/6W +/-5%	1	R526	
18-CB0471-JNX	RES. C.F. 470 OHM 1/6W +/-5%	1	R527	
18-CB0472-JNX	RES. C.F. 4.7k OHM 1/6W +/-5%	1	R502	
18-CB0472-JNX	RES. C.F. 4.7k OHM 1/6W +/-5%	1	R505	
18-CB0472-JNX	RES. C.F. 4.7k OHM 1/6W +/-5%	1	R508	
18-CB0681-JNX	RES. C.F. 680 OHM 1/6W +/-5%	1	R523	
18-CB0751-JNX	RES. C.F. 750 OHM 1/6W +/-5%	1	R503	
18-CB0751-JNX	RES. C.F. 750 OHM 1/6W +/-5%	1	R506	
18-CB0751-JNX	RES. C.F. 750 OHM 1/6W +/-5%	1	R509	
18-CD0104-JNX	RES. C.F. 100K OHM 1/4W +/-5%	1	R521	

Item No.	Description	Quantity Req.	Designator	Remarks
18-FE0272-JNX	RES. M.O. 2.7K OHM 1/2W +/-5%	1	R514	
18-FE0272-JNX	RES. M.O. 2.7K OHM 1/2W +/-5%	1	R515	
18-FE0272-JNX	RES. M.O. 2.7K OHM 1/2W +/-5%	1	R518	
18-FG0183-JHX	RES. M.O. 18K OHM 2W +/-5%	1	R510	
18-FG0183-JHX	RES. M.O. 18K OHM 2W +/-5%	1	R511	
18-FG0183-JHX	RES. M.O. 18K OHM 2W +/-5%	1	R512	
25-BCB221-M1X	CAP. ELEC 220 UF 16V +/-20%	1	C508	
26-AIM103-KBX	CAP. CER 0.01UF 500V +/-10% B	1	C504	
26-AMK221-KBX	CAP. CER 220PF 2KV +/-10% B	1	C505	
26-EBP103-ZFX	CAP. CER 0.01UF 50V +80/-20% F	1	C514	
26-EBP103-ZFX	CAP. CER 0.01UF 50V +80/-20% F	1	C507	
26-EBP681-JCX	CAP. CER 680 pF 50V +/-5%	1	C501	
26-EBP681-JCX	CAP. CER 680 pF 50V +/-5%	1	C502	
26-EBP681-JCX	CAP. CER 680 pF 50V +/-5%	1	C503	
35-139730-00X	FERR. BEAD BF60	2		FOR C514 (L505 & L506)
40-02135S-CRD	P.C.B. CRT BD	1		
41-WJ0050-B00	WIRE BARE JUMPER 5MM	1		FOR Q505 (B - E)
41-WJ0050-B00	WIRE BARE JUMPER 5MM	1		FOR Q509 (B - E)
41-WJ0050-B00	WIRE BARE JUMPER 5MM	1		FOR Q507 (B - E)
41-WJ0060-B00	WIRE BARE JUMPER 6mm	1	J505	
41-WJ0075-B00	WIRE BARE JUMPER 7.5MM	1	J502	
41-WJ0075-B00	WIRE BARE JUMPER 7.5MM	1	J503	
41-WJ0100-B00	WIRE BARE JUMPER 10MM	1	J501	
41-WJ0100-B00	WIRE BARE JUMPER 10MM	1	J504	
46-10967W-01X	PIN BASE *1 TJC1-1A	1	P503	
46-28816H-05X	HS 5P24 500 TJC3-5Y/SCN-5Y	1		P501 P2 -P6 FOR M.BD P201
46-30615H-04X	HS 4P24 460 F/W TJC3-4Y/SCN-4	1		P502 FOR M. BD P402
47-CRT004-XX0	CRT SOCKET GZS10-2-AC2	1	S501	
08-2127SG-AG0	ASS'Y - AG PACKING PARTS	1		
75-2165LL-EC1	POLYFOAM	0		
75-2165LR-EC1	POLYFOAM	0		
75-2165UL-EC1	POLYFOAM	0		
75-2165UR-EC1	POLYFOAM	0		
76-AT2127-0AT	CARTON BOX	0		
08-2127SG-FCN	ASS'Y - FRONT CABINET	1		

Item No.	Description	Quantity Req.	Designator	Remarks
02-GND021-XX0	ASS"Y - CRT GND WIRE&HOUSE	1		
36-DEG210-BX3	DEGAUSSING COIL 2500mm	1		
42-51216D-XX0	SPEAKER (50MMX120MM) 16 OHM 5W	1	W601	
42-51216D-XX0	SPEAKER (50MMX120MM) 16 OHM 5W	1	W602	
44-21OFLS-SG2A	CRT A51JSY63X13(CR)ORG (AFSA)	1	CRT01	
46-27250H-02X	HS 2P24 450/5 F/W TJC3-02H	1		P602H FOR M. BD P602
46-27688H-04X	HS 4P A/B 400/13 RBGW TJC1/4Y	1		P401H FOR D.Y COIL
46-37144H-02X	HS 2P 2468#22 450mm S11-2Y/7mm	1		P601H FOR M. BD P601
54-113970-0U0	PVC TUBE #5 L=ROLL	0.32		FOR SPK HOUSING
54-114000-00X	FELT TAPE (150mmX19mmX0.3mm)	4		
54-205140-000	SPACER CRT MOUNTING T=2MM	4		MTG CRT & F.CAB
54-314740-0X0	CRT FIBRE SHEET (22mmX22mmX0.8mm)	8		MTG CRT & F.CAB
55-2127FC-1CN	FRONT CABINET	1		
56-2127FB-0HA	PUSH BUTTON	1		
56-2127LE-0HC	LENS	1		
56-2127PK-0HA	POWER KNOB	1		
56-379600-0HN	DECORATIVE KNOB	1		
57-10654X-00F	cablE ties□(2.5mmX95mm)	10		
58-2135SI-2UI	INLAY SIDE AV	1		
59-130460-00X	RUBBER PAD (25mmX7mm)	2		FOR FRONT CAB.(FOOTING)
59-312160-000	SPEAKER RUBBER CUSHION	8		MTG SPK & F. CAB.
62-216340-0UN	HOLDER POWER CORD HIPS-KINGFA 113(VO)	1		
62-262660-0HN	POWER SW.ADAPTER	1		
62-345690-1UN	ASSISTANT RAIL HIPS-KINGFA 113 (VO)	1		FOR M.BD TRACK(F.CAB.)
63-B30100-AB4	S/T SCREW B 3 X 10 AB	2		MTG SIDE AV BD & F. CAB.
63-W30060-AB4	S/T SCREW W 3 X 6 AB	1		MTG LENS & FRONT CAB.
63-W30100-AB4	S/T SCREW W 3 X 10 AB	2		MTG PUSH BUTTON & FRONT CAB.
63-W30100-AB4	S/T SCREW W 3 X 10 AB	2		MTG M.BD TRARK & F. CAB.
63-W30120-AB4	S/T SCREW W 3 X 12 AB	8		MTG SPK & FRONT CAB.
63-Z60300-AB4	S/T SCREW HA 6X30	4		MTG CRT & FRONT CAB.
67-X12668-0E0	SPRING CRT 6mmX40mmX0.5mm	1		
67-X24283-0E0	SPING POWER KNOB	1		
08-2127SG-OT2	ASS"Y - OTHER PARTS	1		
02-IRR001-XX1	IR RECEIVER MODULE HRM380017	1	IR001	
07-457FF5-NX8	TUNER TEDH9-251A	1	TU101	

Item No.	Description	Quantity Req.	Designator	Remarks
11-C124ES-0BX	TRANSISTOR PDTC124ES (NPN)	1	Q006	
11-C124ES-0BX	TRANSISTOR PDTC124ES (NPN)	1	Q902	
11-C124ES-0BX	TRANSISTOR PDTC124ES (NPN)	1	Q904	
11-SC1815-YBX	TRANSISTOR 2SC1815Y	1	Q609	
11-SC1815-YBX	TRANSISTOR 2SC1815Y	1	Q603	
11-SC1815-YBX	TRANSISTOR 2SC1815Y	1	Q602	
13-000040-53P	IC 4053 (ANALOG SW)	1	IC901	
13-000040-66P	IC 4066 (ANALOG SW.)	1	IC902	
13-A21V01-TOP	MCU 8823KRNG(TCL-A21V01-TO)	1	IC201	
14-LED05R-XX1	LED RED FB205	1	D051B	
18-CB0102-JNX	RES. C.F. 1K OHM 1/6W +/-5%	1	R637	
18-CB0102-JNX	RES. C.F. 1K OHM 1/6W +/-5%	1	R612A	
18-CB0102-JNX	RES. C.F. 1K OHM 1/6W +/-5%	1	R613A	
18-CB0102-JNX	RES. C.F. 1K OHM 1/6W +/-5%	1	R928	
18-CB0102-JNX	RES. C.F. 1K OHM 1/6W +/-5%	1	R927	
18-CB0102-JNX	RES. C.F. 1K OHM 1/6W +/-5%	1	R911	
18-CB0102-JNX	RES. C.F. 1K OHM 1/6W +/-5%	1	R925	
18-CB0102-JNX	RES. C.F. 1K OHM 1/6W +/-5%	1	R930	
18-CB0102-JNX	RES. C.F. 1K OHM 1/6W +/-5%	1	R931	
18-CB0103-JNX	RES. C.F. 10K OHM 1/6W +/-5%	1	R414	
18-CB0103-JNX	RES. C.F. 10K OHM 1/6W +/-5%	1	R010	
18-CB0103-JNX	RES. C.F. 10K OHM 1/6W +/-5%	1	R917	
18-CB0103-JNX	RES. C.F. 10K OHM 1/6W +/-5%	1	R919	
18-CB0152-JNX	RES. C.F. 1.5k OHM 1/6W +/-5%	1	R020	
18-CB0182-JNX	RES. C.F. 1.8K OHM 1/6W +/-5%	1	R021	
18-CB0222-JNX	RES. C.F. 2.2k OHM 1/6W +/-5%	1	R016	
18-CB0223-JNX	RES. C.F. 22k OHM 1/6W +/-5%	1	R910	
18-CB0223-JNX	RES. C.F. 22k OHM 1/6W +/-5%	1	R909	
18-CB0223-JNX	RES. C.F. 22k OHM 1/6W +/-5%	1	R907	
18-CB0223-JNX	RES. C.F. 22k OHM 1/6W +/-5%	1	R908	
18-CB0223-JNX	RES. C.F. 22k OHM 1/6W +/-5%	1	R612	
18-CB0223-JNX	RES. C.F. 22k OHM 1/6W +/-5%	1	R613	
18-CB0272-JNX	RES. C.F. 2.7k OHM 1/6W +/-5%	1	R022	
18-CB0432-JNX	RES. C.F. 4.3K OHM 1/6W +/-5%	1	R023	
18-CB0470-JNX	RES. C.F. 47 OHM 1/6W +/-5%	1	R018	

Item No.	Description	Quantity Req.	Designator	Remarks
18-CB0682-JNX	RES. C.F. 6.8K OHM 1/6W +/-5%	1	R024	
18-CB0820-JNX	RES. C.F. 82 OHM 1/6W +/-5%	1	R929	
18-CE0479-JNX	RES. C.F. 4.7 OHM 1/2W +/-5%	1	R918	
18-EG0129-JHX	RES. FUS. 1.2 OHM 2W +/-5%	1	R420	
18-FF0122-JGX	RES. M.O. 1.2k OHM 1W +/-5%	1	R411	
18-FG0229-JHX	RES. M.O. 2.2 OHM 2W +/-5%	1	R309	
25-BCB100-M1X	CAP. ELEC 10 UF 16V +/-20%	1	C919	
25-BCB100-M1X	CAP. ELEC 10 UF 16V +/-20%	1	C920	
25-BCB101-M1X	CAP. ELEC 100 UF 16V +/-20%	1	C921	
25-BCB101-M1X	CAP. ELEC 100 UF 16V +/-20%	1	C904	
25-BCB220-M1X	CAP. ELEC 22 UF 16V +/-20%	1	C015	
25-BCB221-M1X	CAP. ELEC 220 UF 16V +/-20%	1	C009	
25-BCB221-M1X	CAP. ELEC 220 UF 16V +/-20%	1	C918	
25-BCB470-M1X	CAP. ELEC 47 UF 16V +/-20%	1	C926	
25-BCB470-M1X	CAP. ELEC 47 UF 16V +/-20%	1	C928	
26-AMK681-KBX	CAP. CER 680 PF 2KV +/-10% B	1	C402	
26-EBP102-KBX	CAP. CER 1000 PF 50V +/-10% B	1	C306	
26-EBP103-ZFX	CAP. CER 0.01UF 50V +80/-20% F	1	C905	
26-EBP103-ZFX	CAP. CER 0.01UF 50V +80/-20% F	1	C917	
26-EBP103-ZFX	CAP. CER 0.01UF 50V +80/-20% F	1	C925	
26-EBP103-ZFX	CAP. CER 0.01UF 50V +80/-20% F	1	C927	
27-AGQ394-JSX	CAP. M.PP 0.39UF 250VAC +/-5%	1	C421	
27-ALR123-J0X	CAP. M PP 0.012 UF 1.6KV +/-5%	1	C406B	
36-LIN500-XX1	COIL LINEARITY 50 UH	1	L412	
37-SC2502-78Q0X	FBT BSC25-0278Q	1	T402	
41-WJ0025-B00	WIRE BARE JUMPER 2.5mm	1		FOR Q903 (C - E)
41-WJ0050-B00	WIRE BARE JUMPER 5MM	1	J025	
41-WJ0050-B00	WIRE BARE JUMPER 5MM	1	J201	
41-WJ0050-B00	WIRE BARE JUMPER 5MM	1	J906	
41-WJ0050-B00	WIRE BARE JUMPER 5MM	1	JP001	
41-WJ0060-B00	WIRE BARE JUMPER 6mm	1	J905	
41-WJ0065-B00	WIRE BARE JUMPER 6.5MM	1	J023	
41-WJ0075-B00	WIRE BARE JUMPER 7.5MM	1	J603	
41-WJ0075-B00	WIRE BARE JUMPER 7.5MM	1	J912	
41-WJ0075-B00	WIRE BARE JUMPER 7.5MM	1	J916	

Item No.	Description	Quantity Req.	Designator	Remarks
41-WJ0075-B00	WIRE BARE JUMPER 7.5MM	1	J915	
41-WJ0075-B00	WIRE BARE JUMPER 7.5MM	1	L411	
41-WJ0080-B00	WIRE BARE JUMPER 8 MM	1	J908	
41-WJ0090-B00	WIRE BARE JUMPER 9MM	1	J909	
45-SAWF18-590	SAW FILTER F1859	1	Z101	
46-28559W-02X	PIN BASE *2 TJC1-2A	1	P802	
46-33079W-05X	PIN BASE *5 TJC3-5A	1		P904 P3 - P7 FOR SIDE AV BD
47-RCA035-XX0	RCA JACK AV-3.2-6W-K	1	P901	
48-POW001-AX0	SWITCH POWER	1	SW801	
48-TAC002-XX0	TACT SWITCH	1	S001	
48-TAC002-XX0	TACT SWITCH	1	S002	
48-TAC002-XX0	TACT SWITCH	1	S003	
48-TAC002-XX0	TACT SWITCH	1	S004	
48-TAC002-XX0	TACT SWITCH	1	S005	
48-TAC002-XX0	TACT SWITCH	1	S006	
50-03150D-1US7	FUSE 250V/3.15A	1	F801	
51-DC0220-0QB01	POWER CORD	1		
62-310430-0HA	LED HOLDER (COMMON)	1		
08-2127SG-PA1	ASS'Y - PACKING PARTS	1		
49-382550-BAT	BATTERY R06P AA 1.5V 5#	2		
62-377580-0HD	SAFEGUARDING COVER PP-H1500 (HB)	2		
72-2127SG-E23	OPERATION MANUAL	1		
74-010050-40C	POLYBAG FOR POWER (10CMX50CM)	1		
74-022032-6WE	POLYBAG (23cmX34cmX0.06mm)	1		FOR OPERATION MANUAL
74-120120-80HAA	POLYBAG W/SUFFOCATION WARNING	1		
08-HS46F0-A123A		1		
11-0BC337-0BX	TRANSISTOR (NPN) BC337-40	1	Q1501	
13-00AS12-13B	IC AS1213B	1	IC1501	
14-IRE05B-XX0	IR EMITTING DIODE TSAL6200	1	D1501	
18-CB0221-JNX	RES. C.F. 220 OHM 1/6W +/-5%	1	R1503	
18-CB0229-JNX	RES. C.F. 2.2 OHM 1/6W +/-5%	1	R1501	
25-BCB101-M1X	CAP. ELEC 100 UF 16V +/-20%	1	C1504	
26-EBP101-JCX	CAP. CER 100PF 50V +/-5% CH	1	C1501	
26-EBP101-JCX	CAP. CER 100PF 50V +/-5% CH	1	C1502	
26-EBP104-ZFX	CAP. CER 0.1UF 50V +80%/-20%	1	C1503	

Item No.	Description	Quantity Req.	Designator	Remarks
40-UOCASF-RMA	P.C.B. REMOTE HANDSET BD	1		
45-COS455-KY1	CERAMIC RESONATOR 455KHz	1	X1501	
49-HS46F0-00X	RUBBER PAD KEYS	1		
55-HS46FB-0HA	CASE LOWER - REMOTE HANDSET	1		
55-HS46FD-0HA	DOOR BATT. - REMOTE HANDSET	1		
55-HS46FT-0HA	CASE UPPER - REMOTE HANDSET	1		
58-HS46F4-4UI	INLAY REMOTE HANDSET	1		
63-B26060-BT2	S/T SCREW B 2.6 X 6 BT	1		
67-X26968-0E2	BATT. TERMINAL (+/-)	1		
67-X31028-0E2	SPRING - BATTERY (-)	1		
67-X31029-0E2	SPRING - BATTERY (+)	1		
74-009022-60C	POLYBAG HANDSET (9CMX22CM)	1		
08-HS46F0-PAY	ASS'Y - PACKING OF IR HANDSET	1		
76-002091-0AT	CARTON BOX LWH 624X384X556MM	0.0031		
76-326350-01A	CARTON SHEET 61X37X0.3CM	0.062		

Alignment Procedure of 2170SG Color TV

1. FLOWCHART OF ALIGNMENT PROCEDURE

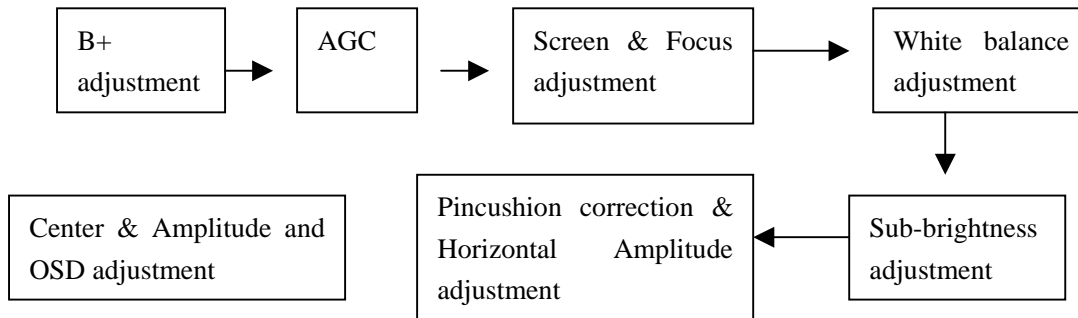

2 Adjustment of B+ voltage

- 1) Apply 120VAC($\pm 5V$) to mains power input, and Philips standard testing pattern to RF input.
- 2) Adjust VR830 in STANDARD mode until voltage at TP2 (B+) is $108V \pm 0.5V$.

3. RF AGC adjustment

Observe monitor the collector waveform of Q101 with the probe of Oscilloscope as illustration below. Select channel 2 ($>70dB$) from the antenna input. Enter D-mode, select menu6 to adjust RFAGC item until the monitor peak value to $0.8V_{p-p}$.

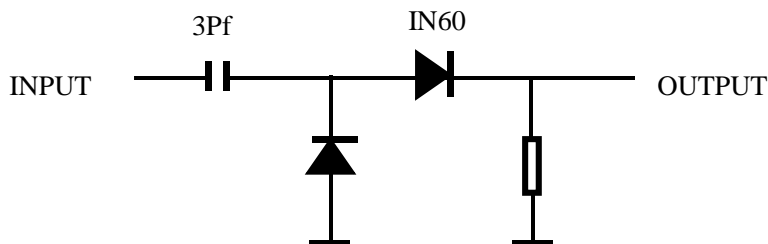

4. Screen & Focus voltage adjustment

Apply pattern signal in normal status, enter D-mode, press “TV/AV” button to turn off the vertical output.

Adjust the SCRREEN switch on the flyback transformer to make a horizontal shining line just visible on the screen.

Turn on the vertical output, adjust the “FOCUS” on the flyback transformer to obtain the optimum focus.

5. White balance adjustment

1) Apply the black and white pattern in normal status;

2) Alignment of normal color temperature

Change Color Temperature to normal status

Use a color analyzer to measure the black side of the screen. By changing the value of RC, GC and BC, set the reading of the color analyzer to X=285, Y=295.

Use a color analyzer to measure the white side of the screen. By changing the value of GD, BD, set the reading of the color analyzer to X=285, Y=295.

Separately set the brightness and contrast from min. to max., repeat the step 2 and 3 until the reading of the color analyzer is correct.

3)Alignment of warm color temperature

Change Color Temperature to warm status

Use a color analyzer to measure the black side of the screen. By changing the value of RC-W, GC-W and BC-W, set the reading of the color analyzer to X=294, Y=303.

Use a color analyzer to measure the white side of the screen. By changing the value of GD-W, BD-W set the reading of the color analyzer to X=294, Y=303.

Separately set the brightness and contrast from min. to max., repeat the step 2 and 3 until the reading of the color analyzer is correct.

4)Alignment of cold color temperature

Change Color Temperature to cold status

Use a color analyzer to measure the black side of the screen. By changing the value of RC-C, GC-C BC-C , set the reading of the color analyzer to X=279, Y=286.

Use a color analyzer to measure the white side of the screen. By changing the value of GD-C, BD-C, set the reading of the color analyzer to X=279, Y=286.

Separately set the brightness and contrast from min. to max., repeat the step 2 and 3 until the reading of the color analyzer is correct

Note: Provided the production line is equipped with the self- White balance adjusting equipment, white balance of M123A chassis can be adjusted automatically as following: Press “I²C BUS” button under factory mode, the TV set will adjust automatically.

6. Adjustment of Sub-brightness,

Apply the Grey-scale/Color bar (NTSC signal) to the AV input, in normal status.

Select BRTC to adjust the sub-brightness, until that the 2nd dark bar of 8 level Grey scale just can be seen.

7. PAL picture geometric adjustment

menu 3

HPOS6/HPOS5 (HZ horizontal center of 60/50 HZ Source)

Menu 2

HIGH6/HIGH5(vertical amplitude)

VCEN5/VCEN6(position of vertical center)

VP60/VP50 (vertical position)

VLIN6/VLIN5 (vertical linearity)

VSC6/VSC5 (V-S Correction)

8 initialization

press **sound-effect** under factory mode, the set will initialize, until “**OK**” appears on the screen which means the initialization is finished. After initialization, the set will quit factory mode automatically.

Factory settings

D-mode:

Enter D-Mode by pressing D-Mode ON/OFF key, and then you can enter the D-mode.

S-mode:

Enter S-Mode by pressing VOLUME DOWN key on the unit until the volume decrease to minimum level, then press the DISPLAY key on the remote handset (don't release the volume key) and you can enter S- mode.

After enter D-mode or S-mode, press **OK**, then press program up/down to select menu from menu 1 to menu 22, press **OK** to enter the menu, press program up/down to select item, press volume up/down to adjust the setting. Press D-mode again to quit factory mode.

You can also enter menu 1 to menu 19 directly by pressing digital button 1~9, 0, notebook, CAP, Display, Sleep, Calendar, System/INS, Favorite, Return, Picture.

Menu 1 (Remote key: "1")

<i>Item</i>	<i>Remark</i>
RC	R cut-off setting
GC	G cut-off setting
BC	B cut-off setting
GD	G drive setting
BD	B drive setting

Menu 2 (Remote key: "2")

<i>Item</i>	<i>Remark</i>
HIGH5	Height (50Hz)
VP50	Vertical position (50Hz)
VLIN5	Vertical linearity (50Hz)
VSC5	Vertical S correction (50Hz)
VBLK5	Vertical blanking start & stop [1C, bit 3 ~ 0]
VCEN5	Vertical center (50Hz)

Menu 2 (Remote key: "2")

<i>Item</i>	<i>Remark</i>
HIGH6	60Hz height
VP60	Vertical position
VLIN6	60Hz Vertical linearity
VSC6	Vertical S correction (60Hz)
VBLK6	Vertical blanking start & stop [1CH, bit 3 ~ 0]
VCEN6	Vertical center (60Hz)

Menu 3 (Remote key: "3")

<i>Item</i>	<i>Remark</i>
HPOS5	Horizontal position (50Hz)

Menu 3 (Remote key: "3")

<i>Item</i>	<i>Remark</i>
HPOS6	Horizontal position (60Hz)

Menu 4 (Remote key: “4”)

<i>Item</i>	<i>Remark</i>
CNTX	Maximum contrast
CNTN	Minimum contrast
BRTX	Maximum brightness
BRTN	Minimum brightness
COLX	Maximum color
COLN	Minimum color
TNTX	Maximum tint level
TNTN	Minimum tint level

Menu 5(Remote key: “5”)

<i>Item</i>	<i>Remark</i>
BRTC	50% brightness
COLC	50% color
COLP	Color level for PAL
SCOL	UV gain [06H, bit 6 ~ 4]
SCNT	Sub-contrast [06H, bit 3 ~ 0]
CNTC	50% contrast
TNTCT	50% tint level (TV mode)
TNTCV	50% tint level (AV mode)

Menu 6(Remote key: “6”)

<i>Item</i>	<i>Remark</i>
ST3	50% Sharpness (TV mode, 3.58 system)
SV3	50% Sharpness (AV mode, 3.58 system)
SV4	50% Sharpness (AV mode, other system)
SVD	50% Sharpness (DVD mode)
ASSH	Asymmetric sharpness [04H, bit 7 ~ 5]
SHPX	Maximum sharpness
SHPN	Minimum sharpness

Menu 7(Remote key: “7”)

<i>Item</i>	<i>Remark</i>	
MOD1	Bit 0,Bit 1	under factory mode : 00,11, STD 01:IRC 10:HRC
	Bit 2	STD, IRC,HRC 1: user control 0: under factory mode
	Bit 3	1: forbid CATV 95/96/97
	Bit 4	
	Bit 5	1: have CCD
	Bit 6	1:have V-CHIP
	Bit 7	1:as Monitor no TV mode
MOD2	Bit 0,Bit 1	Speed of searching
	Bit 2	High sensitivity ; 1 : yes 0:no
	Bit 3	Volume control : 1:PWM
	Bit 4	AV1: 1 : yes 0:no
	Bit 5	AV2: 1 : yes 0:no
	Bit 6	YUV: 1 : yes 0:no
	Bit 7	
MOD3	Bit 0	
	Bit 1	
	Bit 2	

	Bit 3	
	Bit 4	
	Bit 5	TV , MSP AVL: 1: yes
	Bit 6	AV , MSP AVL : 1:yes
	Bit 7	MONO+SAP : 1 : yes 0 : no
OPT	Bit 0	When blue background off (mute pin of CPU): 0: audio mute on 1: audio mute off
	Bit 1	When blue background off (external mute pin of CPU): 0: audio mute on 1: audio mute off
	Bit 2	When change channel: 0: picture mute off 1: picture mute on
	Bit 3	Switch between TV and CATV or change channel in the tune menu 1: picture mute on
	Bit 4	AFT –MUTE 1: ON,
	Bit 5	Polarity of Tint
	Bit 6	
	Bit 7	
OPTM1	Bit 0	TDA98500 0:no 1:yes
	Bit 1	MSP34xx 0:no 1:yes
	Bit 2	1: AV audio out mute when volume is zero or mute
	Bit 3	1: decreasing contrast when menu on
	Bit 4	1: OSD don't disappear automatically
	Bit 5	1:biological
	Bit 6	0: CH LOCK W/O V-CHIP
	Bit 7	When turn on 0:child lock off 1:child lock on
OPTM2	Bit 0	
	Bit 1	Power on mode: 00: standby 01:previous
	Bit 2	10&11: force power on
	Bit 3	Hotel mode 1:on 0: off
	Bit 4	Power on under hotel mode :
	Bit 5	00: TV 01: Video1 02: TV2 03: Last
	Bit 6	1: under factory mode turn off the set by the remote or power off, then turn on or power on, the set enter factory mode
	Bit 7	1: D-MODE
HDCNT		
HSTOP		

Menu 8 (Remote key: "8")

<i>Item</i>	<i>Remark</i>
RFAGC	RFAGC [12H, bit 5 ~ 0]
BRTS	Sub brightness for SECAM
OSD	Horizontal position of OSD
OSDF	OSD PLL DATA
CCD OSD	Horizontal position of CCD OSD
CCD OSDF	PLL DATA of CCD OSD
TXCX	OSD intensity when maximum contrast
RGCN	OSD intensity when minimum contrast

Menu 9(Remote key: “9”)

<i>Item</i>	<i>Remark</i>
V01	Volume 1
V25	Volume 25
V50	Volume 50
V100	Volume 100
VOLMAX	Max volume under hotel mode
CURTCEN	Center of the curtain
VOLX	Output gain of PIN28 of TMPA8823 or MSP34x5
PWTM	When use PWM to mute and no sound when changing channel, this item should be minimum as possible

Menu 10(Remote key: “0”)

<i>Item</i>	<i>Remark</i>	
MDOE4	Bit 0	TV Color system AUTO : 1 : yes 0 : no
	Bit 1	TV Color system NTSC358 : 1 : yes 0 : no
	Bit 2	TV Color system PALM : 1 : yes 0 : no
	Bit 3	TV Color system PALN : 1 : yes 0 : no
	Bit 4	AV Color system AUTO : 1 : yes 0 : no
	Bit 5	AV Color system NTSC358 : 1 : yes 0 : no
	Bit 6	AV Color system PALM : 1 : yes 0 : no
	Bit 7	AV Color system PALN : 1 : 1 : yes 0 : no
MDOE5	Bit 0	English: 1 : yes 0 : no
	Bit 1	French: 1 : yes 0 : no
	Bit 2	Portuguese: 1 : yes 0 : no
	Bit 3	Spanish : 1 : yes 0 : no
	Bit 4	AV Color system PAL443 : 1 : 1 : yes 0 : no
	Bit 5	AV Color system NTSC443 : 1 : 1 : yes 0 : no
	Bit 6	AV AUTO : 1:AUTO1(PAL443 、 NTSC358 、 NTSC443) 0:AUTO2(NTSC358、 PALM、 PALN)
	Bit 7	
MDOE6	Bit 0	1:auto search function of the menu key on the front panel
	Bit 1	1: curtain when turn on the set
	Bit 2	1: curtain when turn off the set
	Bit3~ 7	V-mute timing when changing channel(01H = 8ms) max :248ms
MDOE7	Bit 0 Bit 1	When sound mode change 11:change to the corresponding mode and ODS display automatically 01: change to the corresponding mode and ODS doesn't display 00,10: change to MONO , ODS doesn't display ;
	Bit 2	00 , 10 : detect BTSC and Korea stereo automatically
	Bit 3	01 : force BTSC 11 : force Korea stereo
	Bit 4	FINE, 1:yes 0 : no
	Bit 5	50Hz block 1:yes 0 : no
	Bit 6	1: contrast change when power on

	Bit 7	
MDOE8	Bit 0	America V-CHIP standard 1 : yes 0 : no
	Bit 1	Canadian V-CHIP 1 : yes 0 : no
	Bit 2	UNRATED , 1 : yes 0 : no
	Bit 3	NO RATING , 1 : yes 0 : no
	Bit 4 ~Bit 7	Time setting for curtain when turn on the set
MDOE9	Bit 0 ~Bit 2	N/A
	Bit 3	S-VIDEO ,0:parallel to AV1 1: parallel to AV2
	Bit 4	1:sound effect w/o mpx (MSP3465)
	Bit 5 ~Bit 7	N/A

Menu 12(Remote key: "CAP")

Item	Remark
OSD2	OSD Horizontal Position
OSDF2	OSD PLL DATA except
PYNX	Normal H.SYNC max
PYNN	Normal H.SYNC min
PYXS	Search H.SYNC max
PYNS	Search H.SYNC min

Menu 13 (Remote key: "Display")

Item	Remark
CLTM	TV mode
CLVO	Video mode
CLVS	s-video mode
	Bit 2 ~ 0 YDL [15H, bit 2 ~ 0] (-40ns~240ns)
	Bit 4 ~ 3 NTSC matrix [03H, bit 7 ~ 6] (N1,N2,DVD)
	Bit 5 C gamma [02H, bit 7] (color gamma on/off)
	Bit 6 P/N ID [17H, bit 4] (PAL/NTSC killer sensit.)
	Bit 7 FID [17H, bit 3] (Killer off)
ABL	Bit 1 ~ 0 ABL gain [16H, bit 5 ~ 4]
	Bit 3 ~ 2 ABL start point [16H, bit 7 ~ 6]
	Bit 4 WPS [00H, bit 7]
	Bit 5 OSD ABCL [16H, bit 3]
DCBS	Bit 1 ~ 0 Black stretch [15H, bit 4 ~ 3]
	Bit 3 ~ 2 Y gamma [15H, bit 6 ~ 5]
	Bit 5 ~ 4 OSD level [16H, bit 1 ~ 0]
	Bit 7 Blank switch [0CH, bit 7]
FLG0	Bit 0 Over modulation [13H, bit 5]
	Bit 1 Aft window size [13H, bit 6]
	Bit 2 Buzz reducer [13H, bit 7]
	Bit 3 Audio gain switch [14H, bit 7]
	Bit 4
	Bit 5
	Bit 6
Bit 7 1: VCO adjust automatically when changing channel	
FLG1	Bit 0 CW SW [06H, bit 7], control PIN26,
	Bit 1 Slice level [1EH, bit 6]
	Bit 2 Mix gain [15H, bit 7]
	Bit 3 V ramp bias [1DH, bit 4]

	Bit 4	
	Bit 5	
	Bit 6	
	Bit 7	SLO f0 shift(test only)

Menu 14 (Remote key: "sleep")

<i>Item</i>	<i>Remark</i>	
HAFC	Bit 1 ~ 0	AFC gain (TV mode) [1CH, bit 5 ~ 4]
	Bit 3 ~ 2	AFC gain (AV mode) [1CH, bit 5 ~ 4]
AGCC		
NOIS		
ONTM	V-mute timing when power on (01H = 16ms)	
NSHP	Decreased level of sharpness when noise reduction is on	
PVLVL	X-ray protection start point (00H → 0V & FFH → 5V)	
PLMT	(01H = 8ms)	

Menu 15 (Remote key: "Calendar")

<i>Item</i>	<i>Remark</i>	
RC-C	R cut-off setting (for cool color temperature)	
GC-C	G cut-off setting (for cool color temperature)	
BC-C	B cut-off setting (for cool color temperature)	
GD-C	G drive setting (for cool color temperature)	
BD-C	B drive setting (for cool color temperature)	

Menu 16 (Remote key: "System/INS")

<i>Item</i>	<i>Remark</i>	
RC-W	R cut-off setting (for warm color temperature)	
GC-W	G cut-off setting (for warm color temperature)	
BC-W	B cut-off setting (for warm color temperature)	
GD-W	G drive setting (for warm color temperature)	
BD-W	B drive setting (for warm color temperature)	
YUVGC	YUV	R cut-off
YUVBC	YUV	B cut-off

Menu 17 (Remote key: "FAV")

<i>Item</i>	<i>Remark</i>	
D-COL	Dynamic color	
D-BRI	Dynamic brightness	
D-CON	Dynamic contrast	
D-SHP	Dynamic sharpness	

Menu 18 (Remote key: "Return")

<i>Item</i>	<i>Remark</i>	
S-COL	Standard color	
S-BRI	Standard brightness	
S-CON	Standard contrast	
S-SHP	Standard sharpness	

Menu 19 (Remote key: "Picture")

<i>Item</i>	<i>Remark</i>
M-COL	Mild color
M-BRI	Mild brightness
M-CON	Mild contrast
M-SHP	Mild sharpness

Menu 20: no shortcut key

<i>Item</i>	<i>Remark</i>
SEG_POINT1	Highest frequency of VHFL
SEG_POINT2	Highest frequency of VHFH
DATA_VL	VHFL bandswitch (BB)
DATA_VH	VHFH bandswitch (BB)
DATA_UF	UHF bandswitch (BB)
SPE_POS1	The channel number treated specially
SPE_DATA1	Bandswitch in which the special channel (BB)
SENSI_ON	
SENSI_OFF	

Menu 21: no shortcut key

<i>Item</i>	<i>Remark</i>
THEATER-BAS	Theater bass
THEATER-TRE	Theater treble
CONCERT-BAS	Concert bass
CONCERT-TRE	Concert treble
BROADCAST-BAS	Brocast bass
BROADCAST-TRE	Brocast treble

Menu 22: no shortcut key

<i>Item</i>	<i>Remark</i>
VOL_MAI	Volume Loudspeaker
GATE	Carrier-Mute
VOL-OUT	AV output gain
AV GAIN	AV input Gain

Note:

Provided the production line is equipped with the self-adjusting equipment, The adjusted item should be based on the result by such equipment.

There's difference between PAL geometric/OSD adjustment and NTSC geometric/OSD adjustment. PAL adjustment must be done before NTSC adjustment.

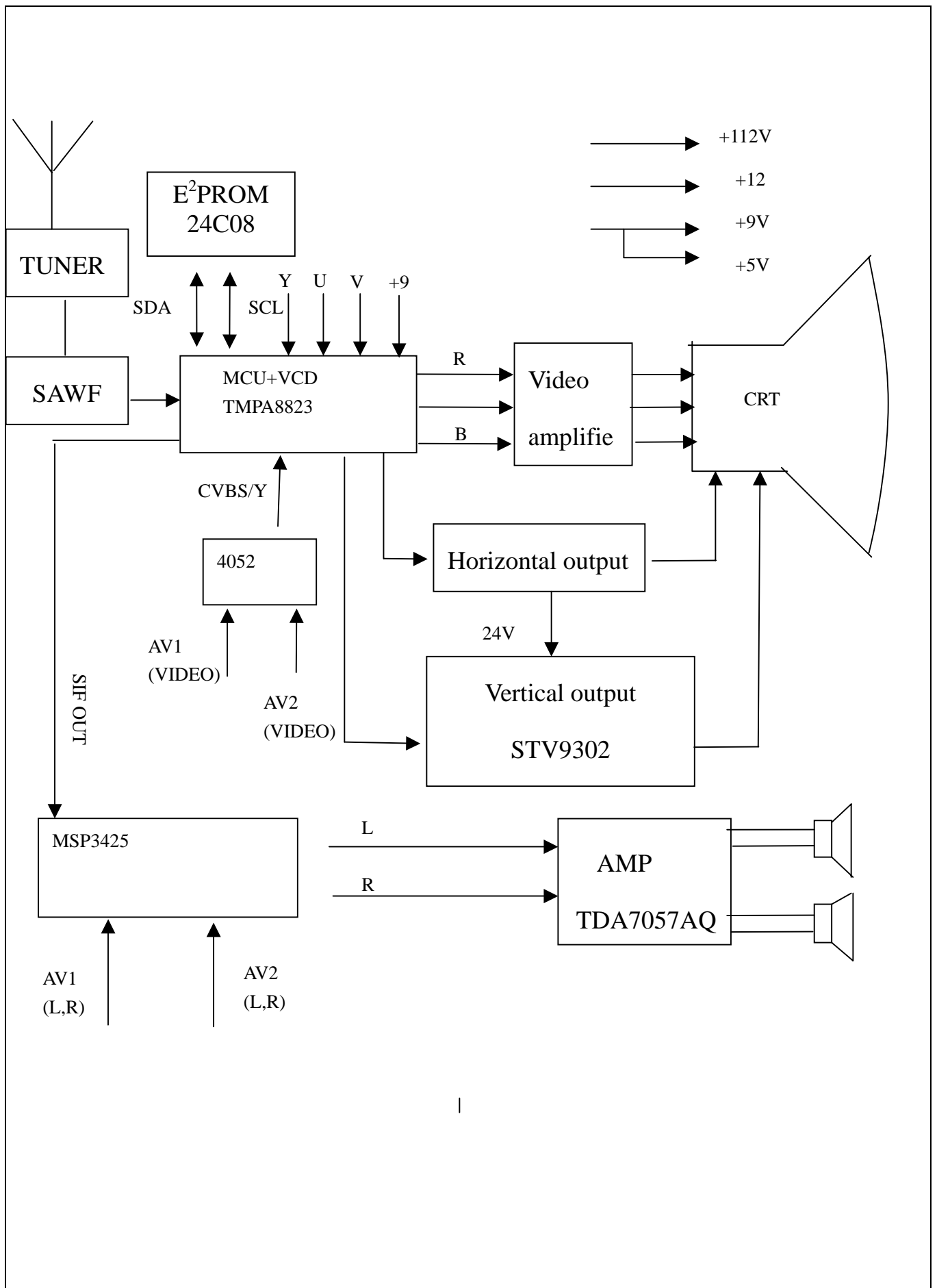

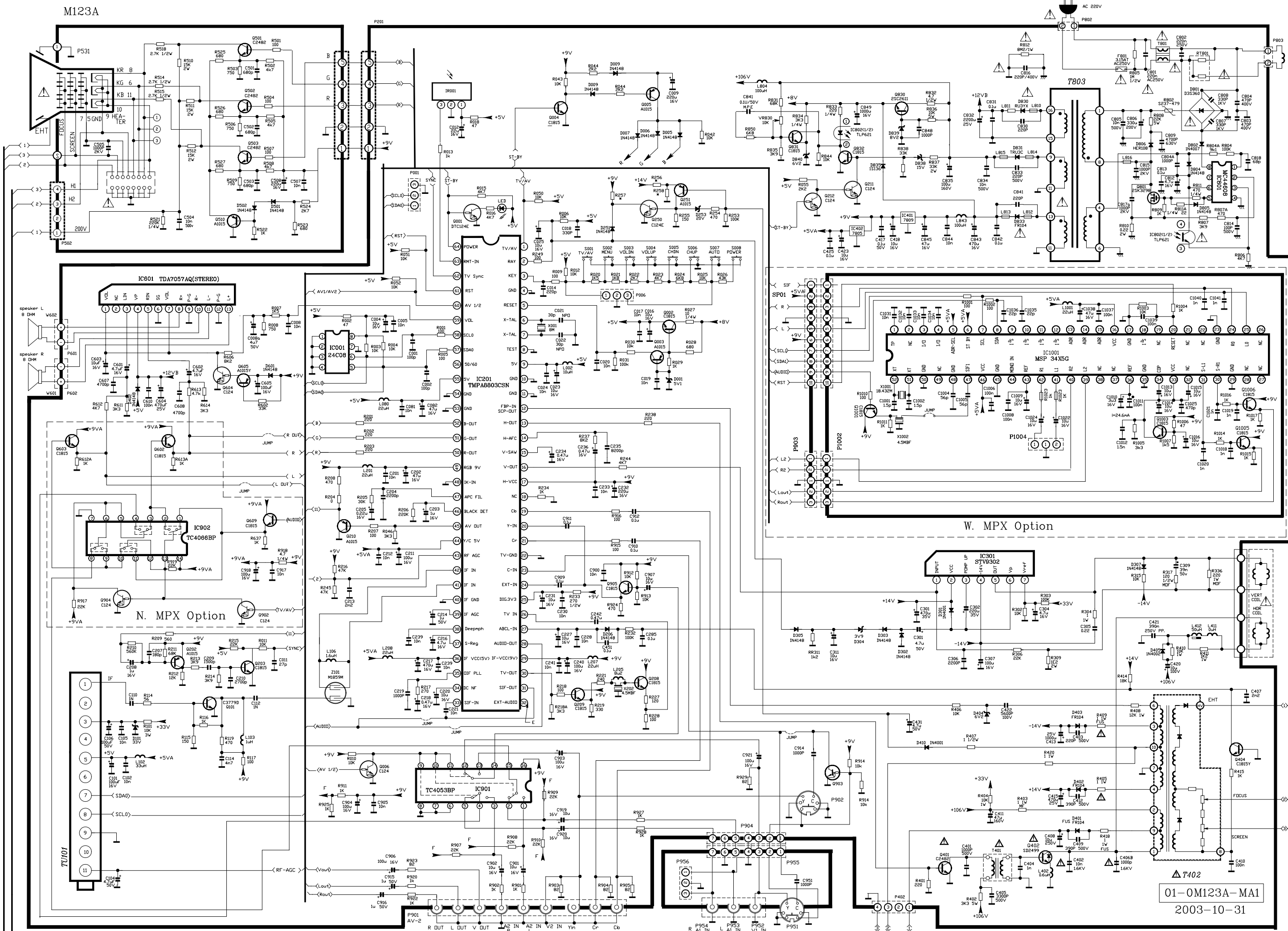

01-0M123A-MA1
2003-10-31

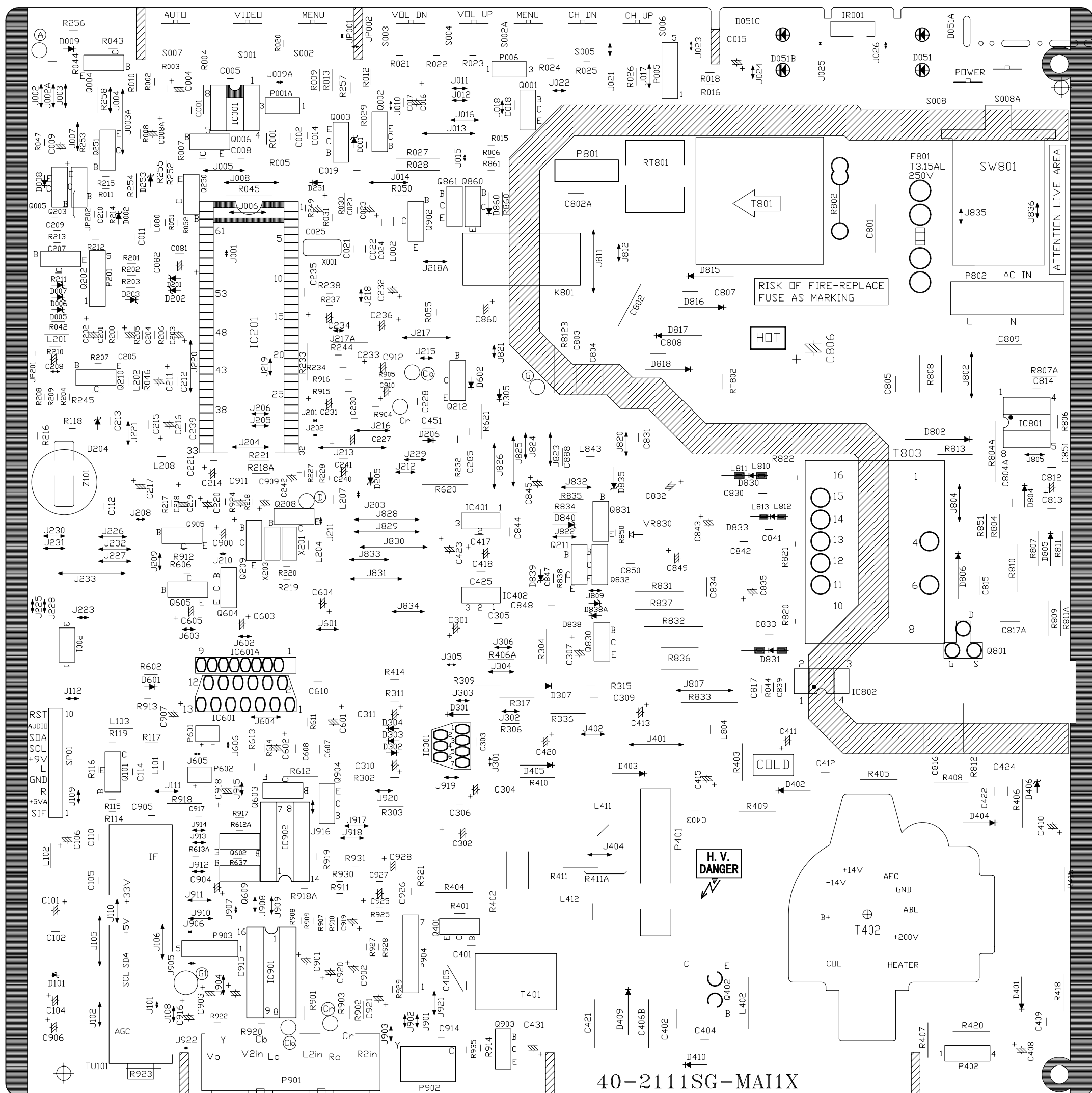

40-2111SG-MA11X

