

1 - Cathode  
2 - Anode  
Back of Case - Cathode

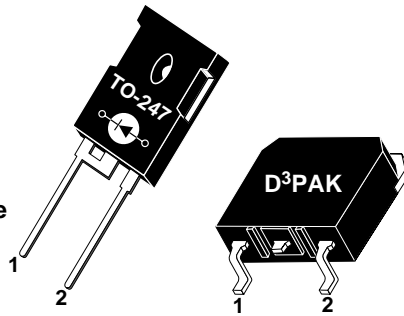

**ADVANCED  
POWER  
TECHNOLOGY®**

**APT30S20B(G) 200V 45A**  
**APT30S20S(G) 200V 45A**

\*G Denotes RoHS Compliant, Pb Free Terminal Finish.

## HIGH VOLTAGE SCHOTTKY DIODE

### PRODUCT APPLICATIONS

- Parallel Diode
  - Switchmode Power Supply
  - Inverters
- Free Wheeling Diode
  - Motor Controllers
  - Converters
- Snubber Diode
- Uninterruptible Power Supply (UPS)
- 48 Volt Output Rectifiers
- High Speed Rectifiers

### PRODUCT FEATURES

- Ultrafast Recovery Times
- Soft Recovery Characteristics
- Popular TO-247 Package or Surface Mount D<sup>3</sup>PAK Package
- Low Forward Voltage
- High Blocking Voltage
- Low Leakage Current

### PRODUCT BENEFITS

- Low Losses
- Low Noise Switching
- Cooler Operation
- Higher Reliability Systems
- Increased System Power Density

### MAXIMUM RATINGS

All Ratings:  $T_C = 25^\circ\text{C}$  unless otherwise specified.

Symbol	Characteristic / Test Conditions	APT30S20B_S(G)	UNIT
$V_R$	Maximum D.C. Reverse Voltage	200	Volts
$V_{RRM}$	Maximum Peak Repetitive Reverse Voltage		
$V_{RWM}$	Maximum Working Peak Reverse Voltage		
$I_F(AV)$	Maximum Average Forward Current ( $T_C = 125^\circ\text{C}$ , Duty Cycle = 0.5)	45	Amps
$I_F(RMS)$	RMS Forward Current (Square wave, 50% duty)	121	
$I_{FSM}$	Non-Repetitive Forward Surge Current ( $T_J = 45^\circ\text{C}$ , 8.3ms)	320	
$T_J, T_{STG}$	Operating and Storage Temperature Range	-55 to 150	$^\circ\text{C}$
$T_L$	Lead Temperature Case for 10 Sec.	300	
$E_{VAL}$	Avalanche Energy (2A, 15mH)	30	mJ

### STATIC ELECTRICAL CHARACTERISTICS

Symbol		MIN	TYP	MAX	UNIT
$V_F$	Forward Voltage	$I_F = 30\text{A}$	.80	.85	Volts
		$I_F = 60\text{A}$	.91		
		$I_F = 30\text{A}, T_J = 125^\circ\text{C}$	.67		
$I_{RM}$	Maximum Reverse Leakage Current	$V_R = V_R$ Rated		0.5	mA
		$V_R = V_R$ Rated, $T_J = 125^\circ\text{C}$		15	
$C_T$	Junction Capacitance, $V_R = 200\text{V}$		150		pF

APT Website - <http://www.advancedpower.com>

# DYNAMIC CHARACTERISTICS

APT30S20B\_S(G)

Symbol	Characteristic	Test Conditions	MIN	TYP	MAX	UNIT
$t_{rr}$	Reverse Recovery Time	$I_F = 30A, di_F/dt = -200A/\mu s$ $V_R = 133V, T_C = 25^\circ C$	-	55		ns
$Q_{rr}$	Reverse Recovery Charge		-	190		nC
$I_{RRM}$	Maximum Reverse Recovery Current		-	6	-	Amps
$t_{rr}$	Reverse Recovery Time	$I_F = 30A, di_F/dt = -200A/\mu s$ $V_R = 133V, T_C = 125^\circ C$	-	100		ns
$Q_{rr}$	Reverse Recovery Charge		-	450		nC
$I_{RRM}$	Maximum Reverse Recovery Current		-	9	-	Amps
$t_{rr}$	Reverse Recovery Time	$I_F = 30A, di_F/dt = -700A/\mu s$ $V_R = 133V, T_C = 125^\circ C$	-	70		ns
$Q_{rr}$	Reverse Recovery Charge		-	960		nC
$I_{RRM}$	Maximum Reverse Recovery Current		-	24		Amps

# THERMAL AND MECHANICAL CHARACTERISTICS

Symbol	Characteristic / Test Conditions	MIN	TYP	MAX	UNIT
$R_{\theta JC}$	Junction-to-Case Thermal Resistance			.58	$^\circ C/W$
$R_{\theta JA}$	Junction-to-Ambient Thermal Resistance			40	
$W_T$	Package Weight		0.22		oz
			5.9		g
Torque	Maximum Mounting Torque			10	lb•in
				1.1	N•m

APT Reserves the right to change, without notice, the specifications and information contained herein.

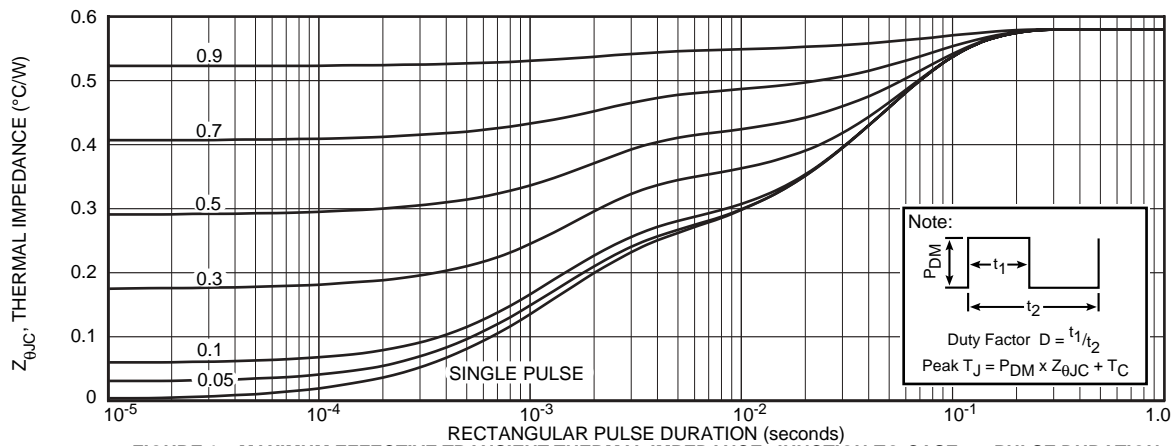

FIGURE 1a. MAXIMUM EFFECTIVE TRANSIENT THERMAL IMPEDANCE, JUNCTION-TO-CASE vs. PULSE DURATION

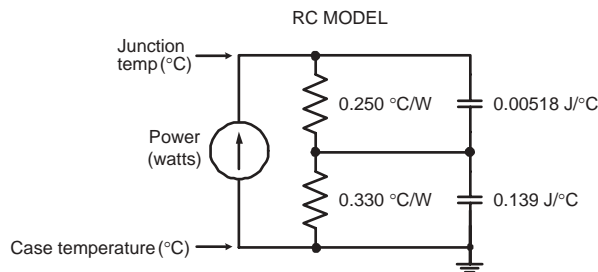

FIGURE 1b. TRANSIENT THERMAL IMPEDANCE MODEL

# TYPICAL PERFORMANCE CURVES

APT30S20B\_S(G)

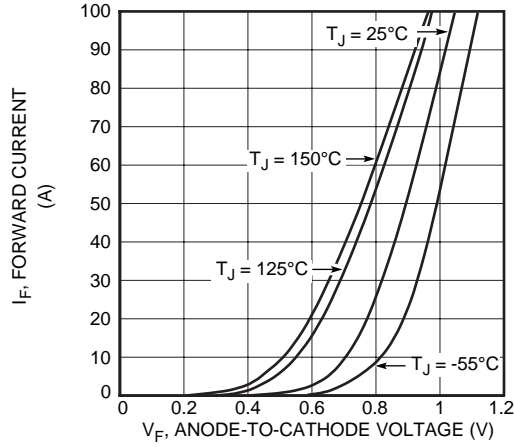

Figure 2. Forward Current vs. Forward Voltage

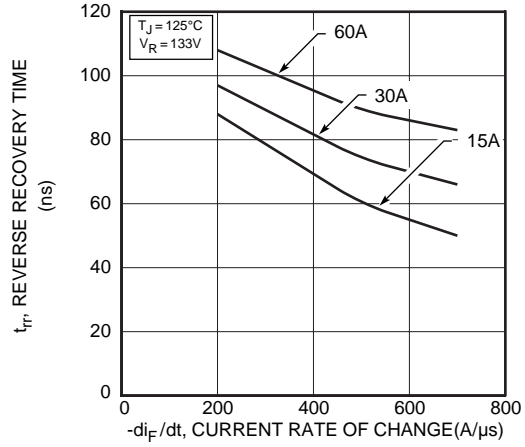

Figure 3. Reverse Recovery Time vs. Current Rate of Change

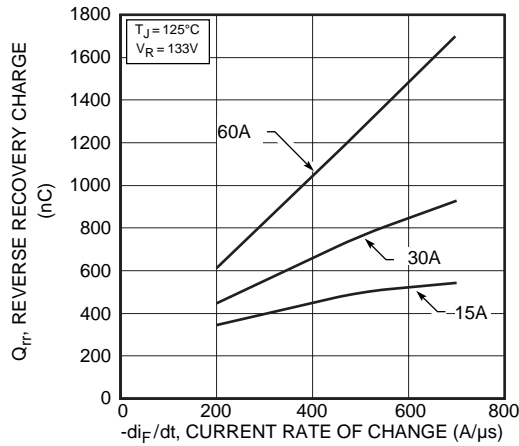

Figure 4. Reverse Recovery Charge vs. Current Rate of Change

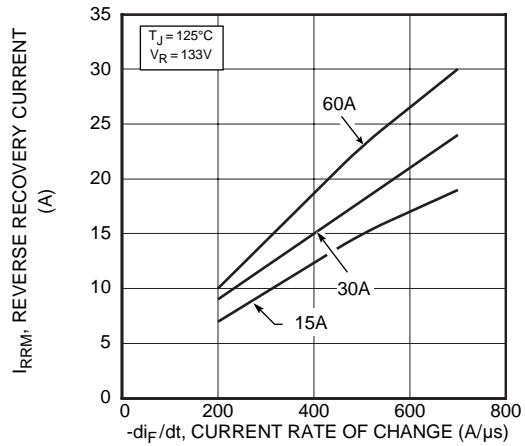

Figure 5. Reverse Recovery Current vs. Current Rate of Change

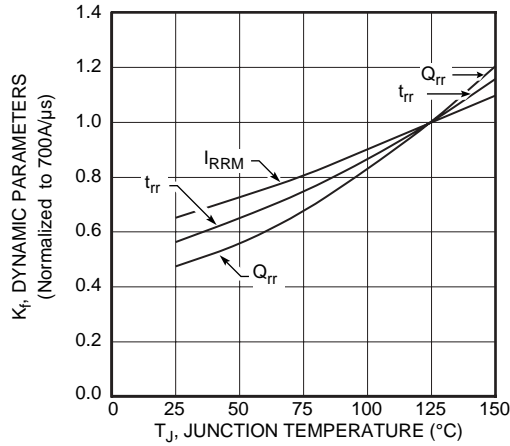

Figure 6. Dynamic Parameters vs. Junction Temperature

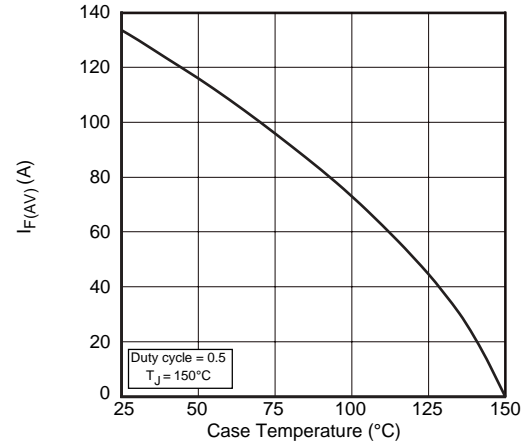

Figure 7. Maximum Average Forward Current vs. Case Temperature

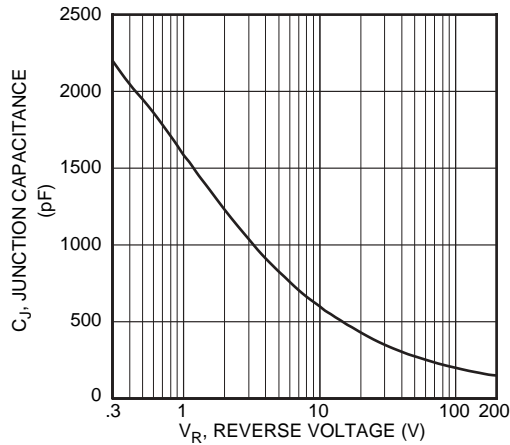

Figure 8. Junction Capacitance vs. Reverse Voltage

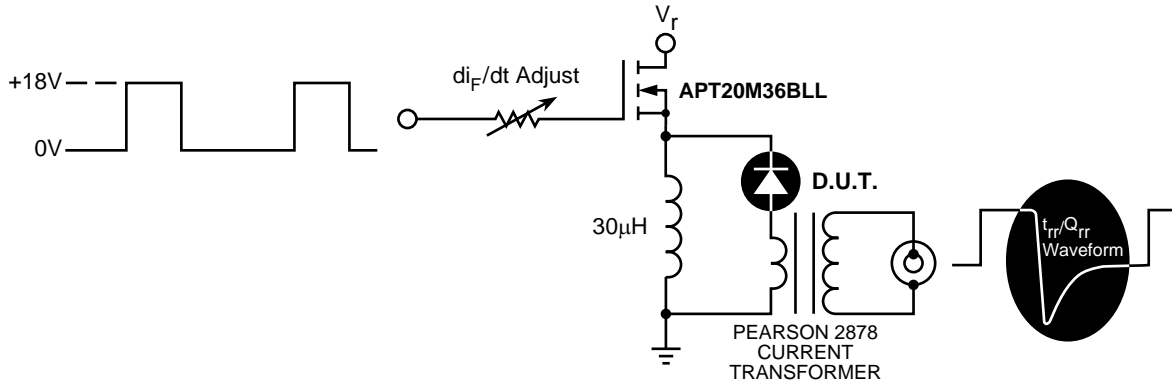

Figure 9. Diode Test Circuit

- 1  $I_F$  - Forward Conduction Current
- 2  $di_F/dt$  - Rate of Diode Current Change Through Zero Crossing.
- 3  $I_{RRM}$  - Maximum Reverse Recovery Current.
- 4  $t_{rr}$  - Reverse Recovery Time, measured from zero crossing where diode current goes from positive to negative, to the point at which the straight line through  $I_{RRM}$  and  $0.25 \cdot I_{RRM}$  passes through zero.
- 5  $Q_{rr}$  - Area Under the Curve Defined by  $I_{RRM}$  and  $t_{rr}$ .

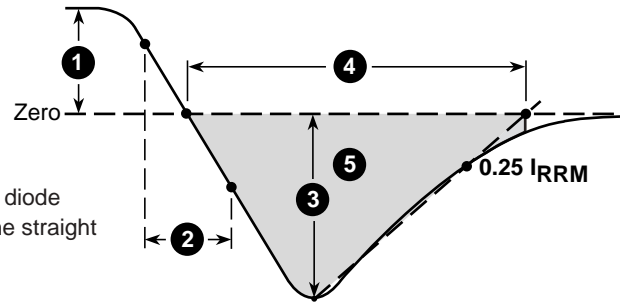

Figure 10, Diode Reverse Recovery Waveform and Definitions

