

# NCV47700

## 5 V to 20 V Adjustable Low Dropout Regulator with Adjustable Current Limit

The NCV47700 is a 350 mA output current integrated low dropout regulator designed for use in harsh automotive environments. It includes wide operating temperature and input voltage ranges. The device is offered with adjustable voltage versions available in 6% output voltage accuracy. It has a high peak input voltage tolerance and reverse input voltage protection. It also provides overcurrent protection, overtemperature protection and enable for control of the state of the output voltage. The integrated current sense feature provides diagnosis and system protection functionality. The current limit of the device is adjustable by resistor connected to CSO pin. Voltage on CSO pin is proportional to output current.

### Features

- Adjustable Voltage Version (from 5 V to 20 V)  $\pm 6\%$  Output Voltage for  $\pm 3\%$  Output Voltage Accuracy see NCV47701 Specification
- Enable Input (5 V Logic Compatible Thresholds) for 3.3 V Logic Compatible Thresholds see NCV47710 or NCV47711 Specification
- Adjustable Current Limit (from 10 mA to 350 mA) with 10% accuracy
- Protection Features:
  - ◆ Current Limitation
  - ◆ Thermal Shutdown
  - ◆ Reverse Input Voltage
- This is a Pb-Free Device

### Typical Applications

- Audio and Infotainment System
- Instrument Cluster
- Navigation
- Satellite Radio

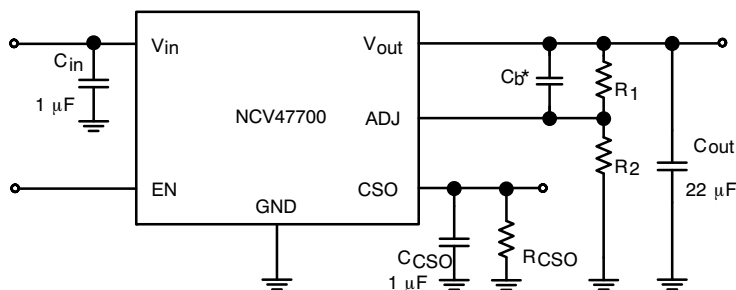

\*Required if usage of low ESR output capacitor  $C_{out}$  is demand, see Regulator Stability Considerations section.

Figure 1. Application Schematic



ON Semiconductor®

<http://onsemi.com>

### MARKING DIAGRAMS



- A = Assembly Location
- L = Wafer Lot
- Y = Year
- W = Work Week
- = Pb-Free Package

### PIN CONNECTIONS

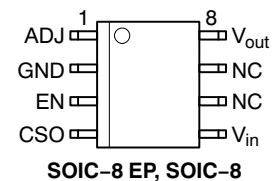

### ORDERING INFORMATION

See detailed ordering and shipping information in the package dimensions section on page 10 of this data sheet.

# NCV47700

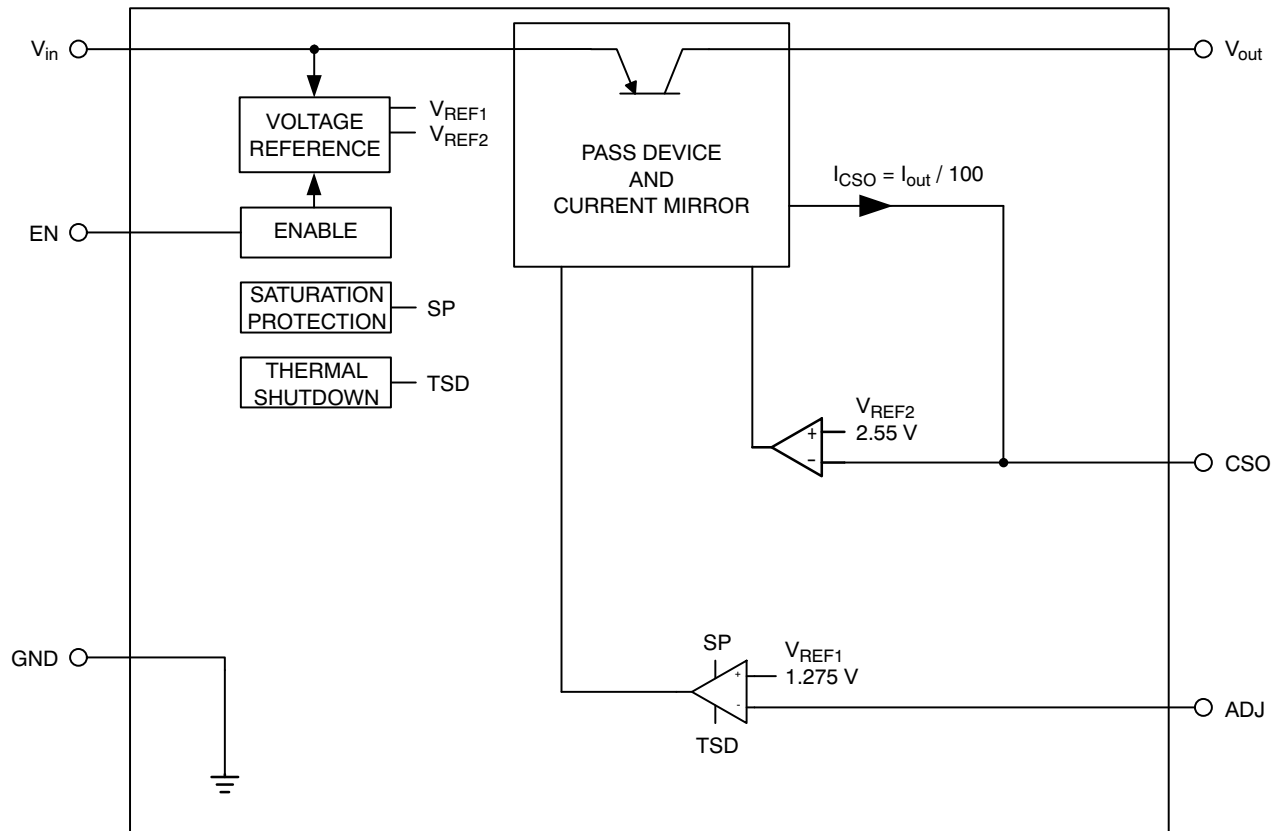

Figure 2. Simplified Block Diagram

## PIN FUNCTION DESCRIPTION

| Pin No. SOIC-8 EP | Pin No. SOIC-8 | Pin Name         | Description   |
|-------------------|----------------|------------------|---|
| 1                 | 1              | ADJ              | Adjustable Voltage Setting Input. See Application Section for more details.   |
| 2                 | 2              | GND              | Power Supply Ground.  |
| 3                 | 3              | EN               | Enable Input; low level disables the IC.  |
| 4                 | 4              | CSO              | Current Sense Output, Current Limit setting and Output Current value information. See Application Section for more details. |
| 5                 | 5              | V <sub>in</sub>  | Positive Power Supply Input.  |
| 6                 | 6              | NC               | Not Connected   |
| 7                 | 7              | NC               | Not Connected   |
| 8                 | 8              | V <sub>out</sub> | Regulated Output Voltage.   |
| EPAD              | -              | EPAD             | Connect to ground potential or leave unconnected.   |

# NCV47700

## ABSOLUTE MAXIMUM RATINGS (Note 1)

| Rating                   | Symbol    | Min  | Max | Unit |
|--------------------------|-----------|------|-----|------|
| Input Voltage            | $V_{in}$  | -42  | 45  | V    |
| Enable Input Voltage     | $V_{EN}$  | -42  | 45  | V    |
| Adjustable Input Voltage | $V_{ADJ}$ | -0.3 | 10  | V    |
| CSO Voltage              | $V_{CSO}$ | -0.3 | 7   | V    |
| Output Voltage           | $V_{out}$ | -1   | 40  | V    |
| Junction Temperature     | $T_J$     | -40  | 150 | °C   |
| Storage Temperature      | $T_{STG}$ | -55  | 150 | °C   |

Stresses exceeding Maximum Ratings may damage the device. Maximum Ratings are stress ratings only. Functional operation above the Recommended Operating Conditions is not implied. Extended exposure to stresses above the Recommended Operating Conditions may affect device reliability.

1. Refer to ELECTRICAL CHARACTERISTICS and APPLICATION INFORMATION for Safe Operating Area.

## ESD CAPABILITY (Note 2)

| Rating                           | Symbol      | Min  | Max | Unit |
|----------------------------------|-------------|------|-----|------|
| ESD Capability, Human Body Model | $ESD_{HBM}$ | -2   | 2   | kV   |
| ESD Capability, Machine Model    | $ESD_{MM}$  | -200 | 200 | V    |

2. This device series incorporates ESD protection and is tested by the following methods:

- ESD Human Body Model tested per AEC-Q100-002 (JS-001-2010)
- ESD Machine Model tested per AEC-Q100-003 (EIA/JESD22-A115)

## LEAD SOLDERING TEMPERATURE AND MSL (Note 3)

| Rating   | Symbol    | Min    | Max      | Unit |
|--|-----------|--------|----------|------|
| Moisture Sensitivity Level<br>SOIC-8 EP<br>SOIC-8                      | MSL       | 2<br>1 |          | -    |
| Lead Temperature Soldering, Reflow (SMD Styles Only), Pb-Free Versions | $T_{SLD}$ | -      | 265 peak | °C   |

3. For more information, please refer to our Soldering and Mounting Techniques Reference Manual, SOLDERRM/D

## THERMAL CHARACTERISTICS (Note 4)

| Rating  | Symbol                           | Value     | Unit |
|---|----------------------------------|-----------|------|
| Thermal Characteristics, SOIC-8 EP (single layer PCB)<br>Thermal Resistance, Junction-to-Air (Note 5)<br>Thermal Reference, Junction-to-Lead (Note 5) | $R_{\theta JA}$<br>$R_{\psi JL}$ | 70<br>19  | °C/W |
| Thermal Characteristics, SOIC-8 EP (4 layers PCB)<br>Thermal Resistance, Junction-to-Air (Note 5)<br>Thermal Reference, Junction-to-Lead (Note 5)     | $R_{\theta JA}$<br>$R_{\psi JL}$ | 29<br>12  | °C/W |
| Thermal Characteristics, SOIC-8 (single layer PCB)<br>Thermal Resistance, Junction-to-Air (Note 5)<br>Thermal Reference, Junction-to-Lead (Note 5)    | $R_{\theta JA}$<br>$R_{\psi JL}$ | 121<br>42 | °C/W |
| Thermal Characteristics, SOIC-8 (4 layers PCB)<br>Thermal Resistance, Junction-to-Air (Note 5)<br>Thermal Reference, Junction-to-Lead (Note 5)        | $R_{\theta JA}$<br>$R_{\psi JL}$ | 77<br>52  | °C/W |

4. Refer to ELECTRICAL CHARACTERISTICS and APPLICATION INFORMATION for Safe Operating Area.

5. Values based on copper area of 645 mm<sup>2</sup> (or 1 in<sup>2</sup>) of 1 oz copper thickness and FR4 PCB substrate. Single layer – according to JEDEC51.3, 4 layers – according to JEDEC51.7.

# NCV47700

## RECOMMENDED OPERATING RANGES (Note 6)

| Rating                               | Symbol         | Min | Max | Unit    |
|--------------------------------------|----------------|-----|-----|---------|
| Input Voltage (Note 7)               | $V_{in}$       | 5.5 | 40  | V       |
| Output Current Limit (Note 8)        | $I_{LIM}$      | 10  | 350 | mA      |
| Junction Temperature                 | $T_J$          | -40 | 150 | °C      |
| Nominal Output Voltage               | $V_{out\_nom}$ | 5.0 | 20  | V       |
| Current Sense Output (CSO) Capacitor | $C_{CSO}$      | 1.0 | 4.7 | $\mu F$ |

6. Refer to ELECTRICAL CHARACTERISTICS and APPLICATION INFORMATION for Safe Operating Area.

7. Minimum  $V_{in} = 5.5 V$  or  $(V_{out\_nom} + 0.5 V)$ , whichever is higher.

8. Corresponding  $R_{CSO}$  is in range from 25 k $\Omega$  down to 728  $\Omega$ .

**ELECTRICAL CHARACTERISTICS**  $V_{in} = 13.5 V$ ,  $V_{EN} = 5 V$ ,  $R_{CSO} = 0 \Omega$ ,  $C_{CSO} = 1 \mu F$ ,  $C_{in} = 1 \mu F$ ,  $C_{out} = 22 \mu F$ ,  $ESR = 1.5 \Omega$ , Min and Max values are valid for temperature range  $-40^\circ C \leq T_J \leq 150^\circ C$  unless otherwise noted and are guaranteed by test design or statistical correlation. Typical values are referenced to  $T_J = 25^\circ C$ .

| Parameter | Test Conditions | Symbol | Min | Typ | Max | Unit |
|-----------|-----------------|--------|-----|-----|-----|------|
|-----------|-----------------|--------|-----|-----|-----|------|

### REGULATOR OUTPUT

|                             |   |              |    |      |     |    |
|-----------------------------|---|--------------|----|------|-----|----|
| Output Voltage (Accuracy %) | $V_{in} = (V_{out\_nom} + 1 V)$ to 40 V, $I_{out} = 5 mA$ to 350 mA         | $V_{out}$    | -6 | -    | 6   | %  |
| Line Regulation             | $V_{in} = (V_{out\_nom} + 1 V)$ to $(V_{out\_nom} + 20V)$ , $I_{out} = 5mA$ | $Reg_{line}$ | -  | 0.1  | 2.0 | %  |
| Load Regulation             | $I_{out} = 5 mA$ to 350 mA  | $Reg_{load}$ | -  | 0.14 | 2.8 | %  |
| Dropout Voltage (Note 9)    | $I_{out} = 150 mA$ , $V_{DO} = V_{in} - V_{out}$                            | $V_{DO}$     | -  | 250  | 500 | mV |

### DISABLE AND QUIESCENT CURRENTS

|   |  |           |   |     |     |               |
|---|--|-----------|---|-----|-----|---------------|
| Disable Current                             | $V_{EN} = 0 V$<br>$V_{EN} = 0 V$ , $T_J = 25^\circ C$  | $I_{DIS}$ | - | -   | 10  | $\mu A$<br>nA |
| Quiescent Current, $I_q = I_{in} - I_{out}$ | $I_{out} = 1 mA$ , $V_{in} = (V_{out\_nom} + 8.5 V)$   | $I_q$     | - | 150 | 230 | $\mu A$       |
| Quiescent Current, $I_q = I_{in} - I_{out}$ | $I_{out} = 350 mA$ , $V_{in} = (V_{out\_nom} + 8.5 V)$ | $I_q$     | - | 23  | 50  | mA            |

### CURRENT LIMIT PROTECTION

|               |   |           |     |   |   |    |
|---------------|---|-----------|-----|---|---|----|
| Current Limit | $V_{out} = 0.9 \times V_{out\_nom}$ , $V_{in} = (V_{out\_nom} + 8.5 V)$ | $I_{LIM}$ | 400 | - | - | mA |
|---------------|---|-----------|-----|---|---|----|

### PSRR & NOISE

|                               |   |       |   |     |   |               |
|-------------------------------|---|-------|---|-----|---|---------------|
| Power Supply Ripple Rejection | $f = 100 Hz$ , $0.5 V_{p-p}$ , $I_{out} = 5 mA$ , $C_{in} = none$ | PSRR  | - | 70  | - | dB            |
| Output Noise Voltage          | $f = 10 Hz$ to 100 kHz, $C_b = 10 nF$ , $I_{out} = 5 mA$          | $V_n$ | - | 100 | - | $\mu V_{rms}$ |

### ENABLE

|  |   |              |          |            |          |         |
|--|---|--------------|----------|------------|----------|---------|
| Enable Input Threshold Voltage<br>Logic Low (OFF)<br>Logic High (ON) | $V_{out} \leq 0.1 V$<br>$V_{out} \geq 0.9 \times V_{out\_nom}$                  | $V_{th(EN)}$ | 0.8<br>- | 2.4<br>2.7 | -<br>3.5 | V       |
| Enable Input Current   | $V_{EN} = 5 V$  | $I_{EN}$     | 2.0      | 8.0        | 20       | $\mu A$ |
| Turn On Time from Enable ON to 90% of $V_{out\_nom}$                 | $I_{out} = 100 mA$ , $C_b = 10 nF$ , $R_1 = 82 k\Omega$ ,<br>$R_2 = 27 k\Omega$ | $t_{on}$     | -        | 1.6        | -        | ms      |

### OUTPUT CURRENT SENSE

|   |   |                   |                 |         |                 |         |
|---|---|-------------------|-----------------|---------|-----------------|---------|
| CSO Voltage Level at Current Limit            | $V_{out} = 0.9 \times V_{out\_nom}$ , $(V_{out\_nom} = 5 V)$<br>$R_{CSO} = 1 k\Omega$                 | $V_{CSO\_llim}$   | 2.346<br>(-8 %) | 2.55    | 2.754<br>(+8 %) | V       |
| CSO Transient Voltage Level                   | $C_{CSO} = 4.7 \mu F$ , $R_{CSO} = 1 k\Omega$ , $I_{out}$ pulse from 10 mA to 350 mA, $t_r = 1 \mu s$ | $V_{CSO}$         | -               | -       | 3.0             | V       |
| CSO Current to Output Current Ratio (Note 10) | $V_{CSO} = 2 V$ , $I_{out} = 10 mA$ to 350 mA,<br>$(V_{out\_nom} = 5V)$                               | $I_{CSO}/I_{out}$ | -<br>(-10%)     | (1/100) | -<br>(+10%)     | -       |
| CSO Current at No Load Current                | $V_{CSO} = 0 V$ , $I_{out} = 0 mA$ , $(V_{out\_nom} = 5 V)$   | $I_{CSO\_off}$    | -               | -       | 10              | $\mu A$ |

### THERMAL SHUTDOWN

|                              |                  |          |     |   |     |    |
|------------------------------|------------------|----------|-----|---|-----|----|
| Thermal Shutdown Temperature | $I_{out} = 5 mA$ | $T_{SD}$ | 150 | - | 195 | °C |
|------------------------------|------------------|----------|-----|---|-----|----|

9. Measured when the output voltage  $V_{out}$  has dropped -2% from the nominal value obtained at  $V_{in} = V_{out\_nom} + 8.5 V$ .

10. Not guaranteed in dropout.

TYPICAL CHARACTERISTICS

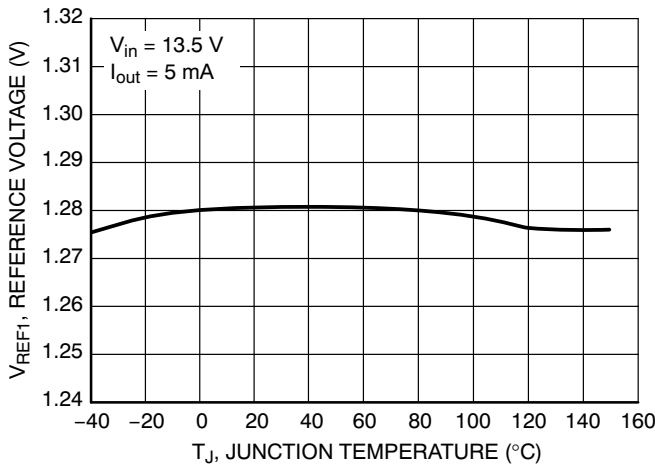

Figure 3. Reference Voltage vs. Temperature

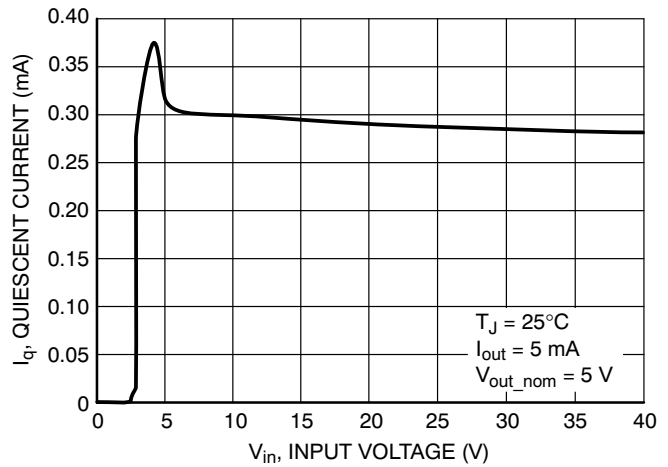

Figure 4. Quiescent Current vs. Input Voltage

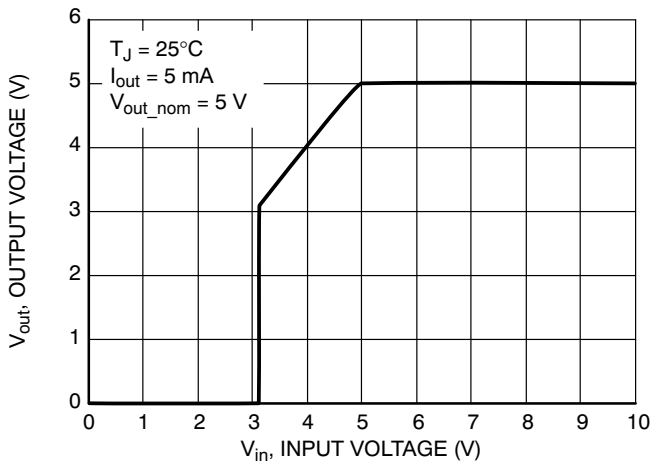

Figure 5. Output Voltage vs. Input Voltage

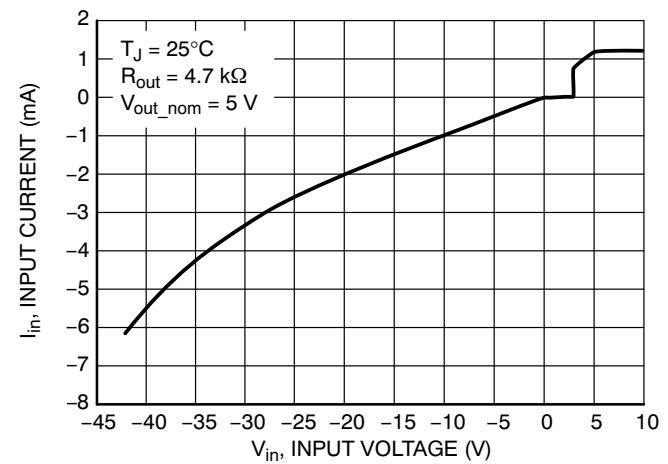

Figure 6. Input Current vs. Input Voltage (Reverse Input Voltage)

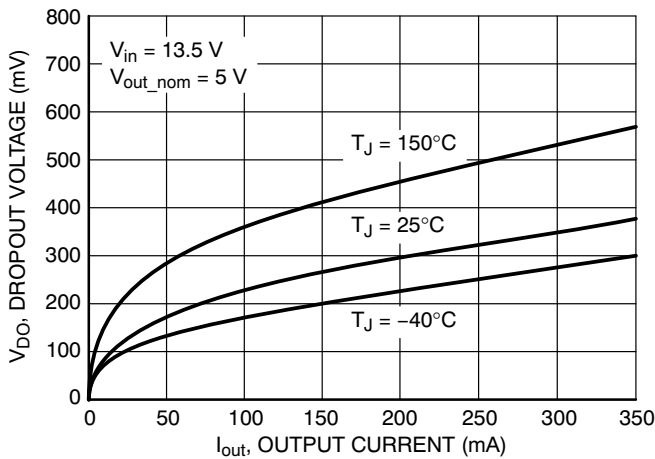

Figure 7. Dropout vs. Output Current

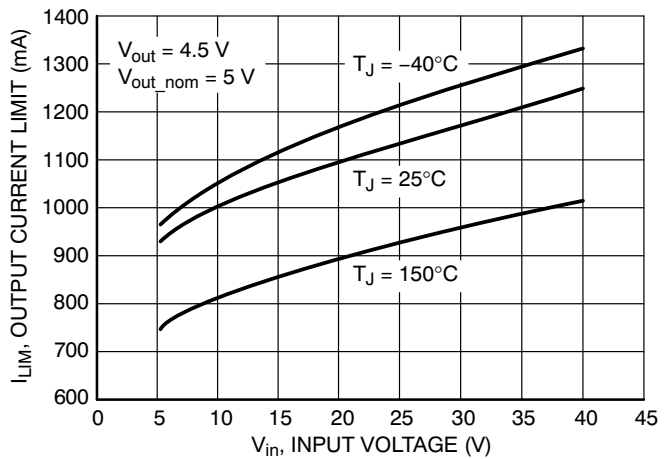

Figure 8. Output Current Limit vs. Input Voltage

TYPICAL CHARACTERISTICS

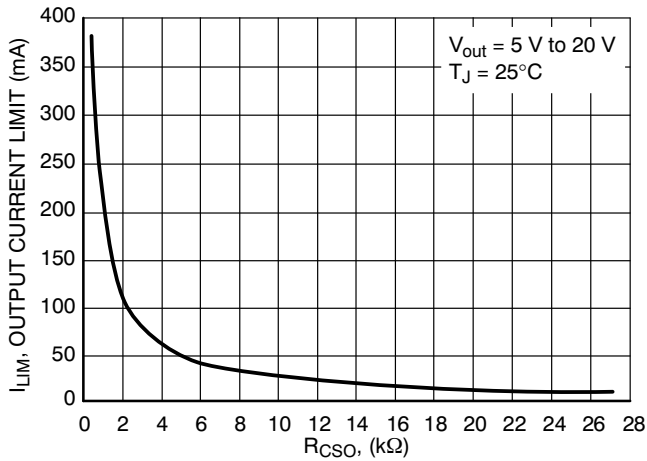

Figure 9. Output Current Limit vs.  $R_{CSO}$

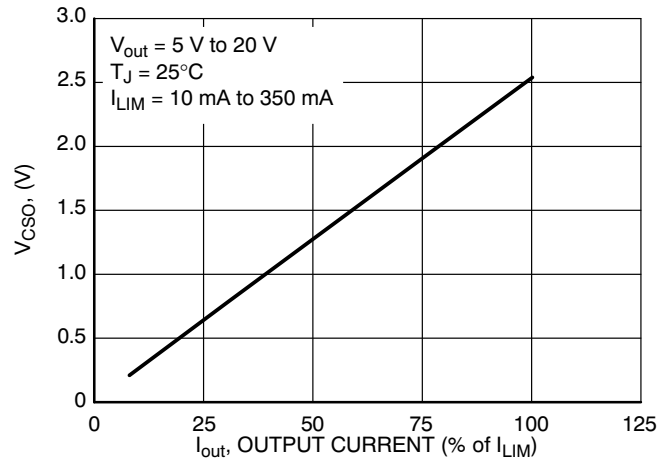

Figure 10. Output Current (% of  $I_{LIM}$ ) vs. CSO Voltage

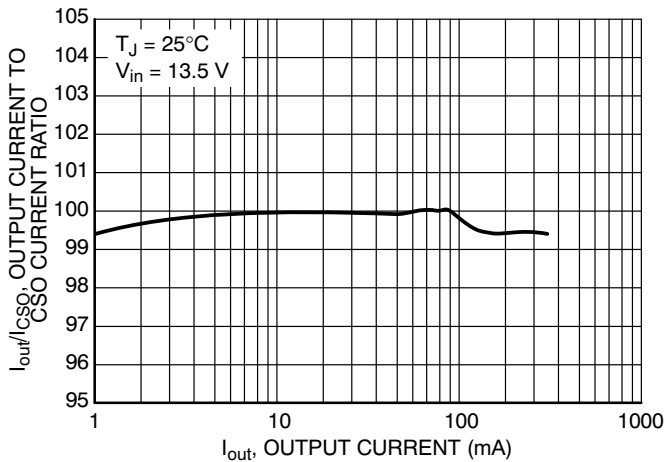

Figure 11. Output Current to CSO Current Ratio vs. Output Current

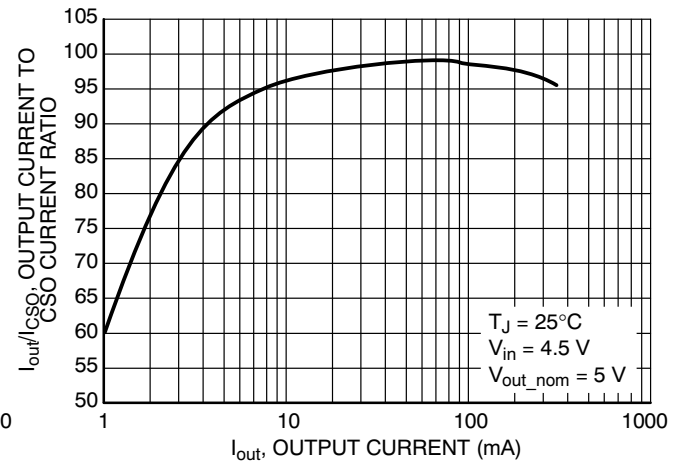

Figure 12. Output Current to CSO Current Ratio vs. Output Current in Dropout

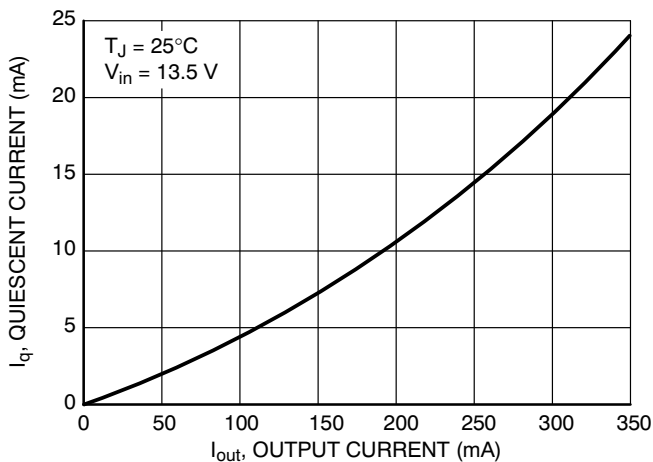

Figure 13. Quiescent Current vs. Output Current (High Load)

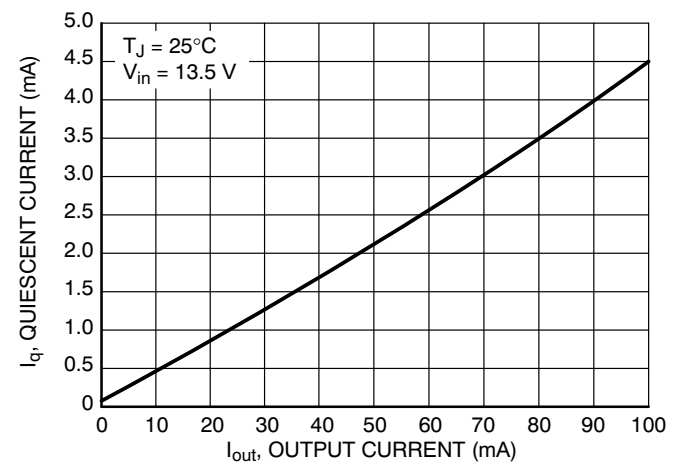

Figure 14. Quiescent Current vs. Output Current (Low Load)

# NCV47700

## TYPICAL CHARACTERISTICS

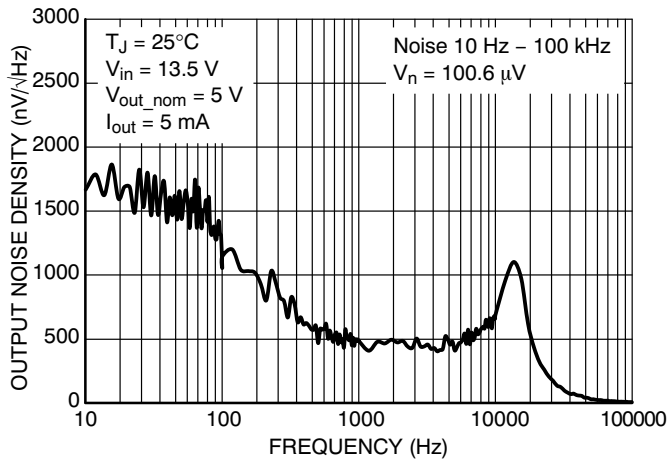

Figure 15. Output Noise Density vs. Frequency

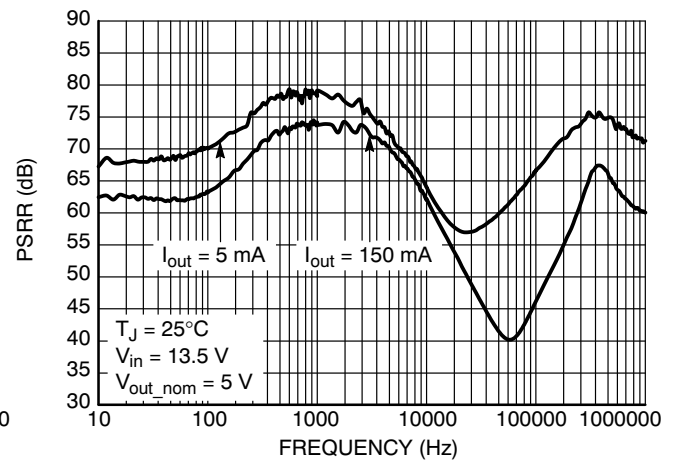

Figure 16. PSRR vs. Frequency

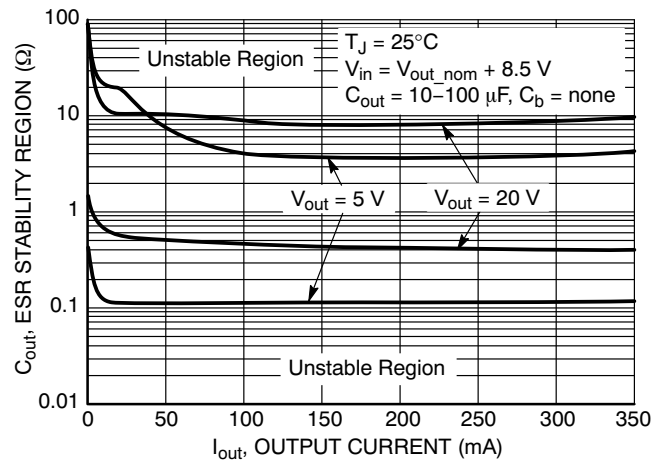

Figure 17.  $C_{out}$  ESR Stability Region vs. Output Current

## DEFINITIONS

### General

All measurements are performed using short pulse low duty cycle techniques to maintain junction temperature as close as possible to ambient temperature.

### Output Voltage

The output voltage parameter is defined for specific temperature, input voltage and output current values or specified over Line, Load and Temperature ranges.

### Line Regulation

The change in output voltage for a change in input voltage measured for specific output current over operating ambient temperature range.

### Load Regulation

The change in output voltage for a change in output current measured for specific input voltage over operating ambient temperature range.

### Dropout Voltage

The input to output differential at which the regulator output no longer maintains regulation against further reductions in input voltage. It is measured when the output voltage  $V_{out}$  has dropped  $-2\%$  from the nominal value obtained at  $V_{in} = V_{out\_nom} + 8.5$  V. The junction temperature, load current, and minimum input supply requirements affect the dropout level.

### Quiescent and Disable Currents

Quiescent Current ( $I_Q$ ) is the difference between the input current (measured through the LDO input pin) and the output load current. If Enable pin is set to LOW the regulator

reduces its internal bias and shuts off the output, this term is called the disable current ( $I_{DIS}$ ).

### Current Limit

Current Limit is value of output current by which output voltage drops below 90% of its nominal value.

### PSRR

Power Supply Rejection Ratio is defined as ratio of output voltage and input voltage ripple. It is measured in decibels (dB).

### Line Transient Response

Typical output voltage overshoot and undershoot response when the input voltage is excited with a given slope.

### Load Transient Response

Typical output voltage overshoot and undershoot response when the output current is excited with a given slope between low-load and high-load conditions.

### Thermal Protection

Internal thermal shutdown circuitry is provided to protect the integrated circuit in the event that the maximum junction temperature is exceeded. When activated at typically  $175^{\circ}\text{C}$ , the regulator turns off. This feature is provided to prevent failures from accidental overheating.

### Maximum Package Power Dissipation

The power dissipation level is maximum allowed power dissipation for particular package or power dissipation at which the junction temperature reaches its maximum operating value, whichever is lower.



APPLICATIONS INFORMATION

**Circuit Description**

The NCV47700 is an integrated low dropout regulator that provides a regulated voltage at 350 mA to the output. It is enabled with an input to the enable pin. The regulator voltage is provided by a PNP pass transistor controlled by an error amplifier with a bandgap reference, which gives it the lowest possible dropout voltage. The output current capability is 350 mA, and the base drive quiescent current is controlled to prevent oversaturation when the input voltage is low or when the output is overloaded. The integrated current sense feature provides diagnosis and system protection functionality. The current limit of the device is adjustable by resistor connected to CSO pin. Voltage on CSO pin is proportional to output current. The regulator is protected by both current limit and thermal shutdown. Thermal shutdown occurs above 150°C to protect the IC during overloads and extreme ambient temperatures.

**Regulator**

The error amplifier compares the reference voltage to a sample of the output voltage (V<sub>out</sub>) and drives the base of a PNP series pass transistor via a buffer. The reference is a bandgap design to give it a temperature-stable output. Saturation control of the PNP is a function of the load current and input voltage. Oversaturation of the output power device is prevented, and quiescent current in the ground pin is minimized.

**Regulator Stability Considerations**

The input capacitor (C<sub>in</sub>) is necessary to stabilize the input impedance to avoid voltage line influences. The output capacitor (C<sub>out</sub>) helps determine three main characteristics of a linear regulator: startup delay, load transient response and loop stability. The capacitor value and type should be based on cost, availability, size and temperature constraints. The aluminum electrolytic capacitor is the least expensive solution, but, if the circuit operates at low temperatures (-25°C to -40°C), both the value and ESR of the capacitor will vary considerably. The capacitor manufacturer’s data sheet usually provides this information. The value for the output capacitor C<sub>out</sub>, shown in Figure 1 should work for most applications; see also Figure 17 for output stability at various load and Output Capacitor ESR conditions. Stable region of ESR in Figure 17 shows ESR values at which the LDO output voltage does not have any permanent oscillations at any dynamic changes of output load current. Marginal ESR is the value at which the output voltage waving is fully damped during four periods after the load change and no oscillation is further observable.

ESR characteristics were measured with ceramic capacitors and additional series resistors to emulate ESR. Low duty cycle pulse load current technique has been used to maintain junction temperature close to ambient temperature.

**Calculating Bypass Capacitor**

If usage of low ESR ceramic capacitors is demanded, connect the bypass capacitor C<sub>b</sub> between Adjustable Input pin and V<sub>out</sub> pin according to Applications circuit at Figure 1. Parallel combination of bypass capacitor C<sub>b</sub> with the feedback resistor R<sub>1</sub> contributes in the device transfer function as an additional zero and affects the device loop stability, therefore its value must be optimized. Attention to the Output Capacitor value and its ESR must be paid. See also Stability in High Speed Linear LDO Regulators Application Note, AND8037/D for more information. Optimal value of bypass capacitor is given by following expression:

$$C_b = \frac{1}{2 \times \pi \times f_z \times R_1} \quad (\text{eq. 1})$$

where

R<sub>1</sub> – the upper feedback resistor

f<sub>z</sub> – the frequency of the zero added into the device transfer function by R<sub>1</sub> and C<sub>b</sub> external components.

Set the R<sub>1</sub> resistor according to output voltage requirement. Chose the f<sub>z</sub> with regard on the output capacitance C<sub>out</sub>, refer to the table below.

|                            |          |        |        |        |
|----------------------------|----------|--------|--------|--------|
| C <sub>out</sub> (μF)      | 10       | 22     | 47     | 100    |
| f <sub>z</sub> range (kHz) | 3.3–48.2 | 1.5–33 | 1.5–33 | 2.2–22 |

Ceramic capacitors and its part numbers listed bellow have been used as low ESR output capacitors C<sub>out</sub> from the table above to define the frequency ranges of additional zero required for stability:

- GRM31CR71C106KAC7 (10 μF, 16 V, X7R, 1206)
- GRM32ER71C226KE18 (22 μF, 16 V, X7R, 1210)
- GRM32ER61C476ME15 (47 μF, 16 V, X5R, 1210)
- GRM32ER60J107ME20 (100 μF, 6.3 V, X5R, 1210)

**Enable Input**

The enable pin is used to turn the regulator on or off. By holding the pin down to a voltage less than 0.8 V, the output of the regulator will be turned off. When the voltage on the enable pin is greater than 3.5 V, the output of the regulator will be enabled to power its output to the regulated output voltage. The enable pin may be connected directly to the input pin to give constant enable to the output regulator.

**Setting the Output Voltage**

The output voltage range can be set between 5 V and 20 V. This is accomplished with an external resistor divider feeding back the voltage to the IC back to the error amplifier by the voltage adjust pin ADJ. The internal reference voltage is set to a temperature stable reference (V<sub>REF1</sub>) of 1.275 V.

# NCV47700

The output voltage is calculated from the following formula. Ignoring the bias current into the ADJ pin:

$$V_{out} = V_{REF1} \left( 1 + \frac{R_1}{R_2} \right) \quad (\text{eq. 2})$$

Use  $R_2 < 50 \text{ k}\Omega$  to avoid significant voltage output errors due to ADJ bias current.

Designers should consider the tolerance of  $R_1$  and  $R_2$  during the design phase.

### Setting the Output Current Limit

The output current limit can be set between 10 mA and 350 mA by external resistor  $R_{CSO}$  (see Figure 1). Capacitor  $C_{CSO}$  of 1  $\mu\text{F}$  in parallel with  $R_{CSO}$  is required for stability of current limit control circuitry (see Figure 1).

$$V_{CSO} = I_{out} \left( R_{CSO} \times \frac{1}{100} \right) \quad (\text{eq. 3})$$

$$I_{LIM} = \frac{100}{1} \times \frac{2.55}{R_{CSO}} \quad (\text{eq. 4})$$

$$R_{CSO} = \frac{100}{1} \times \frac{2.55}{I_{LIM}} \quad (\text{eq. 5})$$

Where

- $R_{CSO}$  – current limit setting resistor
- $V_{CSO}$  – voltage at CSO pin proportional to  $I_{out}$
- $I_{LIM}$  – current limit value
- $I_{out}$  – output current actual value

CSO pin provides information about output current actual value. The CSO voltage is proportional to output current according to Equation 3.

Once output current reaches its limit value ( $I_{LIM}$ ) set by external resistor  $R_{CSO}$  than voltage at CSO pin is typically 2.55 V. Calculations of  $I_{LIM}$  or  $R_{CSO}$  values can be done using equations Equation 4 and Equation 5, respectively.

### Thermal Considerations

As power in the NCV47700 increases, it might become necessary to provide some thermal relief. The maximum power dissipation supported by the device is dependent upon board design and layout. Mounting pad configuration on the PCB, the board material, and the ambient temperature affect the rate of junction temperature rise for the part. When the NCV47700 has good thermal conductivity through the PCB, the junction temperature will be relatively low with

high power applications. The maximum dissipation the NCV47700 can handle is given by:

$$P_{D(MAX)} = \frac{[T_{J(MAX)} - T_A]}{R_{\theta JA}} \quad (\text{eq. 6})$$

Since  $T_J$  is not recommended to exceed  $150^\circ\text{C}$ , then the NCV47700 soldered on  $645 \text{ mm}^2$ , 1 oz copper area, FR4 can dissipate up to 1.8 W (SOIC-8 EP) or 1 W (SOIC-8) and up to 4.3 W (SOIC-8 EP) or 1.6 W (SOIC-8) for 4 layers PCB (all layers are 1 oz) when the ambient temperature ( $T_A$ ) is  $25^\circ\text{C}$ . See Figure 18 for  $R_{thJA}$  versus PCB area. The power dissipated by the NCV47700 can be calculated from the following equations:

$$P_D = V_{in}(I_q@I_{out}) + I_{out}(V_{in} - V_{out}) \quad (\text{eq. 7})$$

or

$$V_{in(MAX)} \approx \frac{P_{D(MAX)} + (V_{out} \times I_{out})}{I_{out} + I_q} \quad (\text{eq. 8})$$

### Hints

$V_{in}$  and GND printed circuit board traces should be as wide as possible. When the impedance of these traces is high, there is a chance to pick up noise or cause the regulator to malfunction. Place external components, especially the output capacitor, as close as possible to the NCV47700 and make traces as short as possible.

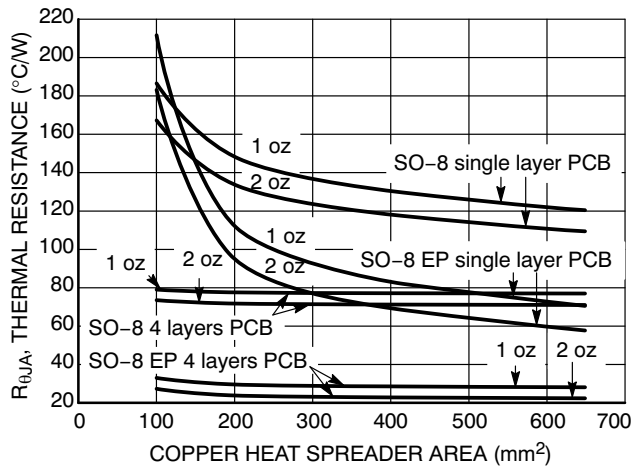

Figure 18. Thermal Resistance vs. PCB Copper Area

### ORDERING INFORMATION

| Device          | Output Voltage | Marking | Package             | Shipping†          |
|-----------------|----------------|---------|---------------------|--------------------|
| NCV47700PDAJR2G | Adjustable     | 47700   | SOIC-8 EP (Pb-Free) | 2500 / Tape & Reel |
| NCV47700DAJR2G  | Adjustable     | 47700   | SOIC-8 (Pb-Free)    | 2500 / Tape & Reel |

†For information on tape and reel specifications, including part orientation and tape sizes, please refer to our Tape and Reel Packaging Specifications Brochure, BRD8011/D.

# NCV47700

## PACKAGE DIMENSIONS

### SOIC-8 EP CASE 751AC ISSUE B

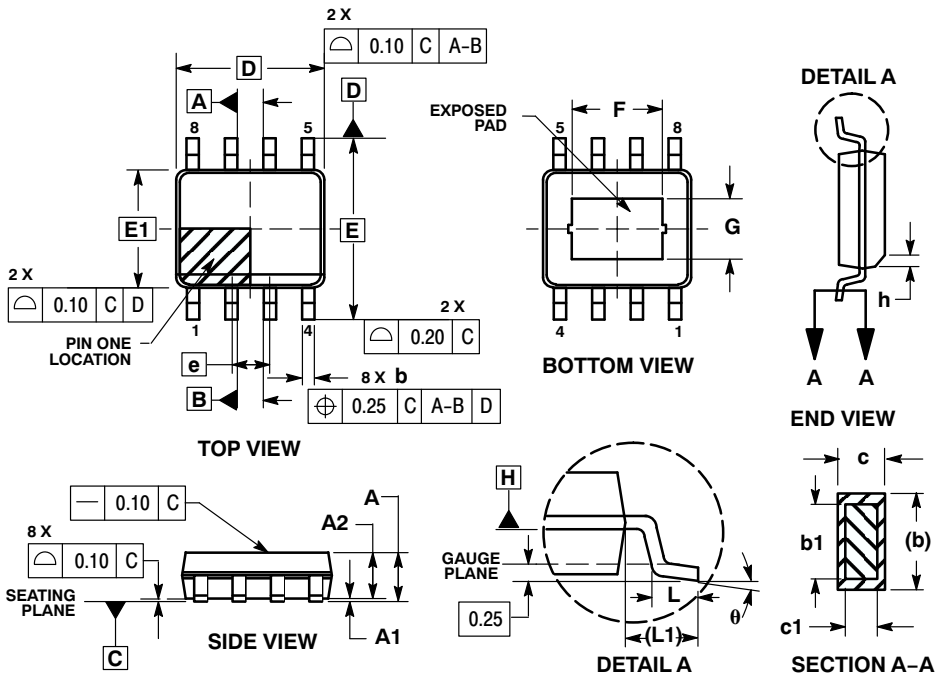

#### NOTES:

1. DIMENSIONS AND TOLERANCING PER ASME Y14.5M, 1994.
2. DIMENSIONS IN MILLIMETERS (ANGLES IN DEGREES).
3. DIMENSION b DOES NOT INCLUDE DAMBAR PROTRUSION. ALLOWABLE DAMBAR PROTRUSION SHALL BE 0.08 MM TOTAL IN EXCESS OF THE "b" DIMENSION AT MAXIMUM MATERIAL CONDITION.
4. DATUMS A AND B TO BE DETERMINED AT DATUM PLANE H.

| DIM | MILLIMETERS |      |
|-----|-------------|------|
|     | MIN         | MAX  |
| A   | 1.35        | 1.75 |
| A1  | 0.00        | 0.10 |
| A2  | 1.35        | 1.65 |
| b   | 0.31        | 0.51 |
| b1  | 0.28        | 0.48 |
| c   | 0.17        | 0.25 |
| c1  | 0.17        | 0.23 |
| D   | 4.90 BSC    |      |
| E   | 6.00 BSC    |      |
| E1  | 3.90 BSC    |      |
| e   | 1.27 BSC    |      |
| L   | 0.40        | 1.27 |
| L1  | 1.04 REF    |      |
| F   | 2.24        | 3.20 |
| G   | 1.55        | 2.51 |
| h   | 0.25        | 0.50 |
| θ   | 0°          | 8°   |

#### SOLDERING FOOTPRINT

