

LM1265HP Series SMD Power Inductors (RoHS Compliant)

1. PART NO. EXPRESSION :

LM 1 2 6 5 HP 4 R 7 M F - □ □
(a) (b) (c) (d) (e)(f) (g)

- (a) Series code
- (b) Dimension code
- (c) Type code

- (d) Inductance code : 4R7 = 4.70uH
- (e) Tolerance code : M = ±20%, Y = ±30%
- (f) F : RoHS Compliant
- (g) 11~99 : Internal controlled number

2. CONFIGURATION & DIMENSIONS :

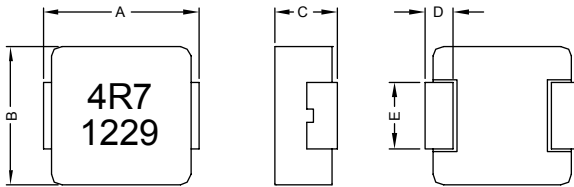

Unit:m/m

A	B	C	D	E
13.5±0.5	12.5±0.3	6.2±0.3	2.3±0.3	4.7±0.3

3. SCHEMATIC :

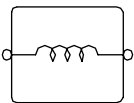

4. MATERIALS :

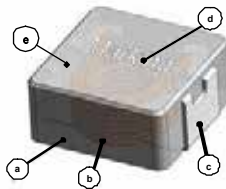

- (a) Core : Carbonyl Powder.
- (b) Wire : Polyester Wire or equivalent
- (c) Solder Plating : 100% Pb free solder
- (d) Ink : Halogen-free ketone
- (e) Paint : Epoxy resin

5. GENERAL SPECIFICATION :

- a) Test Freq. : L : 100KHz/1.0V
- b) Ambient Temp. : 25° C
- c) Operating Temp. : -40° C to +125° C
- d) Storage Temp. : -10° C to +40° C
- e) Humidity Range : 50 ~ 60% RH (Product without taping)
- f) Heat Rated Current (I_{rms}) will cause the coil temperature rise approximately Δt of 40°C (keep 1min.)
- g) Saturation Current (I_{sat}) will cause L₀ to drop 20% typical. (keep quickly).
- h) Part Temperature (Ambient+Temp. Rise) : Should not exceed 125° C under worst case operating conditions.

LM1265HP Series

SMD Power Inductors (RoHS Compliant)



6. ELECTRICAL CHARACTERISTICS :

Part No.	Inductance L _o (μ H) \pm 20% @ 0 A	I _{rms} (A) Typ.	I _{sat} (A) Typ.	DCR (m Ω) Typ. @ 25° C	DCR (m Ω) Max. @ 25° C
LM1265HPR33MF	0.33	46	68	0.65	0.8
LM1265HPR40MF	0.40	44	64	0.7	1.0
LM1265HPR45MF	0.45	42	63	0.9	1.2
LM1265HPR47MF	0.47	41	63	0.9	1.2
LM1265HPR50MF	0.50	40	60	0.92	1.25
LM1265HPR82MF	0.82	33	50	1.5	1.9
LM1265HP1R5MF	1.50	27	45	2.5	3.0
LM1265HP2R2MF	2.20	22	37	3.8	4.2
LM1265HP3R3MF	3.30	18	30	5.7	6.8
LM1265HP4R7MF	4.70	13.5	28	7.0	8.4
LM1265HP5R6MF	5.60	12.5	23	8.5	10
LM1265HP6R8MF	6.80	11.5	18	9.5	11.5
LM1265HP8R2MF	8.20	10.5	16	12	15.5
LM1265HP330MF	33.0	8	11	48	58
LM1265HP101MF	100	2.5	3.5	180	200

Dwg No. : D:\TLDR-S12015C\PIC1265HP SERIES.DWG



LM1265HP Series SMD Power Inductors (RoHS Compliant)



7. CHARACTERISTICS CURVES :

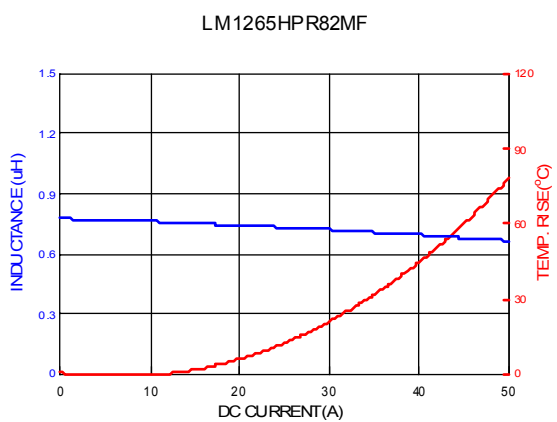
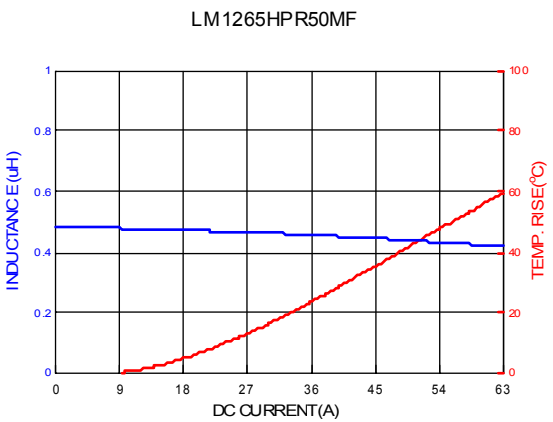
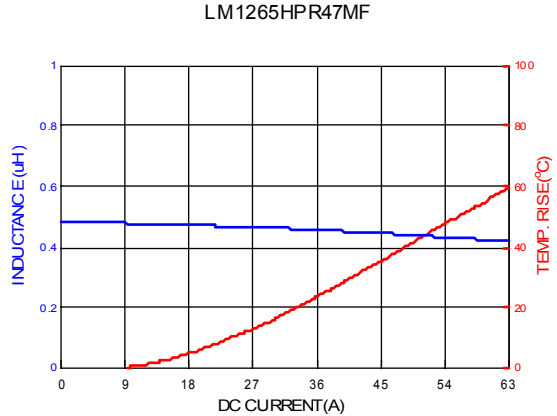
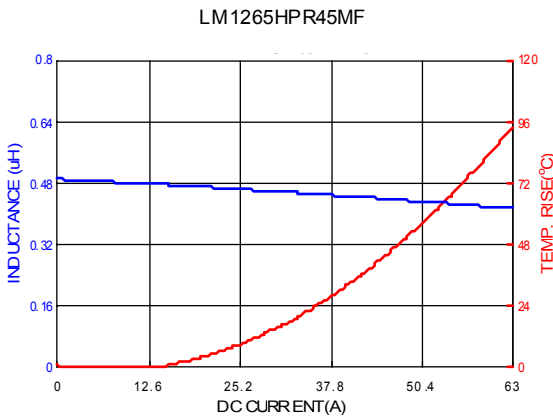
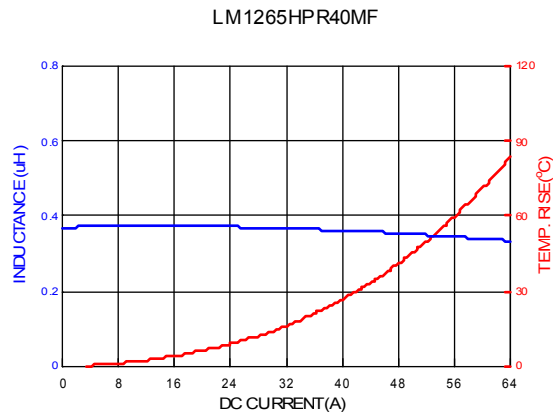
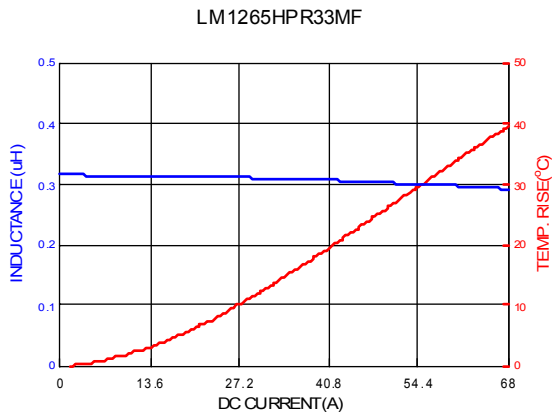

RoHS

LM1265HP Series SMD Power Inductors (RoHS Compliant)



7. CHARACTERISTICS CURVES :

LM1265HP1R5MF

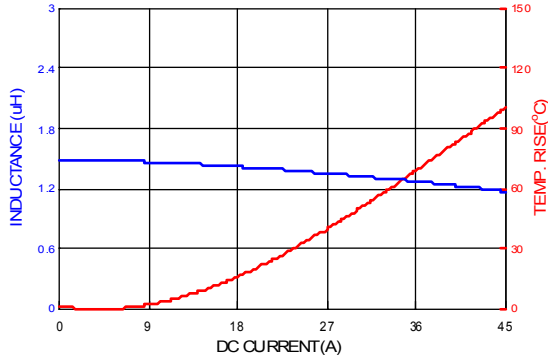

LM1265HP2R2MF

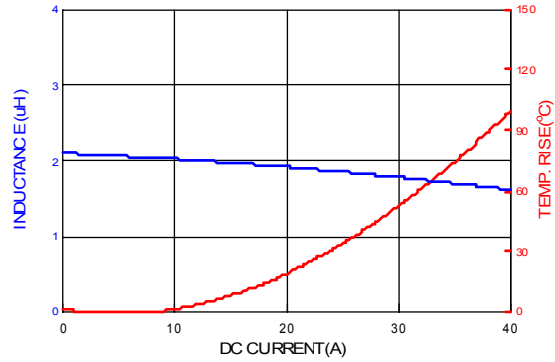

LM1265HP3R3MF

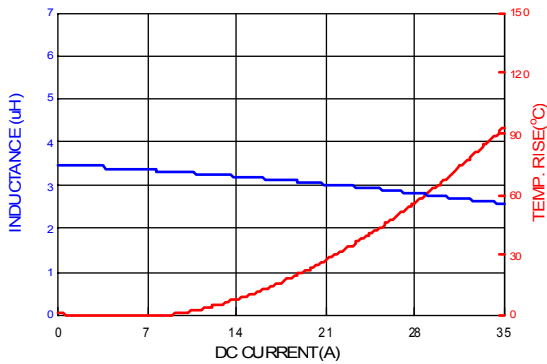

LM1265HP4R7MF

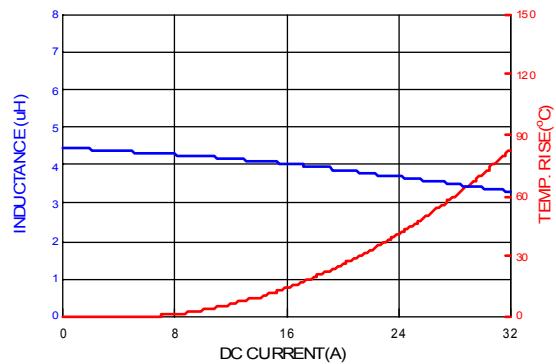

LM1265HP5R6MF

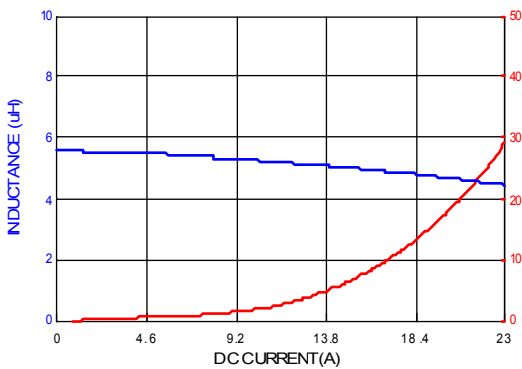

LM1265HP6R8MF

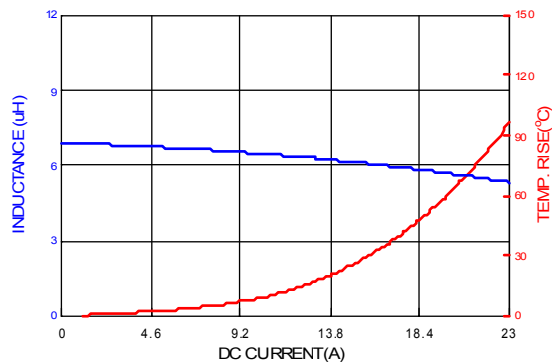

Dwg No. : D:\TLDR-S12015C\PIC1265HP SERIES.DWG

LM1265HP Series SMD Power Inductors (RoHS Compliant)



7. CHARACTERISTICS CURVES :

LM1265HP8R2MF

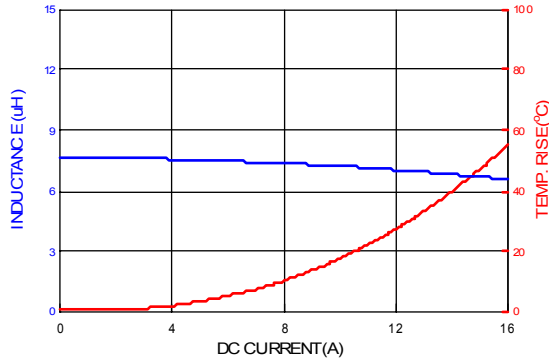

LM1265HP330MF

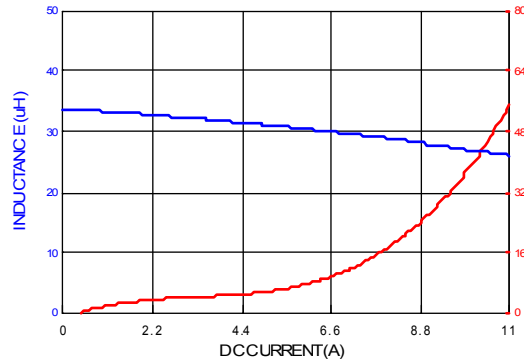

LM1265HP101MF

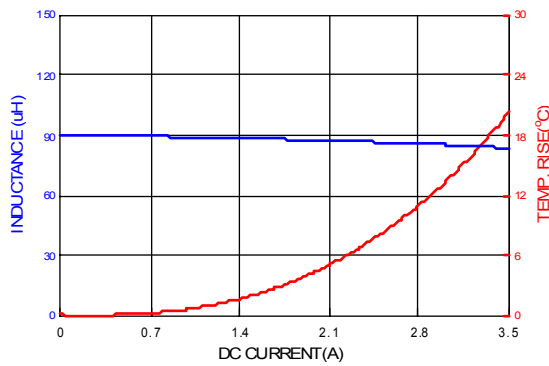

LM1265HP Series

SMD Power Inductors (RoHS Compliant)



8. RELIABILITY AND TEST CONDITION

ITEM	PERFORMANCE	TEST CONDITION												
Electrical Characteristics Test														
Inductance	Refer to standard electrical characteristics list	HP4284A, CH11025, CH3302, CH1320, CH1320S LCR meter.												
DCR		CH16502, Agilent33420A Micro-Ohm Meter.												
Heat Rated Current (I _{rms})	Approximately $\Delta T \leq 40^{\circ}\text{C}$	I _{rms} (A) will cause the coil temperature rise approximately $\Delta T(^{\circ}\text{C})$ without core loss 1. Applied the allowed DC current(keep 1min). 2. Temperature measured by digital surface thermometer												
Saturation Current (I _{sat})	$\Delta L 20\%$ typical.	I _{sat} (A) will cause L _o to drop $\Delta L(\%)$ (keep quickly).												
Reliability Test														
High Temperature Exposure Test	Electric specification should be satisfied	Temperature : $125 \pm 2^{\circ}\text{C}$ Time : 1000 ± 12 hours Measured at room temperature after placing for 2 to 3hrs (MIL-PRF-27)												
Low Temperature Life Test		Temperature : $-40 \pm 2^{\circ}\text{C}$ Time : 500 ± 12 hours Measured at room temperature after placing for 2 to 3hrs												
Thermal Shock Test		Conditions of 1 cycle. <table border="1"> <thead> <tr> <th>Step</th> <th>Temperature ($^{\circ}\text{C}$)</th> <th>Times (min.)</th> </tr> </thead> <tbody> <tr> <td>1</td> <td>$-40 \pm 0/-2$</td> <td>15 ± 1</td> </tr> <tr> <td>2</td> <td>Room Temperature</td> <td>Within ≤ 0.2</td> </tr> <tr> <td>3</td> <td>$+125 \pm 2/-0$</td> <td>15 ± 1</td> </tr> </tbody> </table> Total : 300 cycles Measure at room temperature after placing for 2 to 3hrs. (AEC-Q200-REV C)	Step	Temperature ($^{\circ}\text{C}$)	Times (min.)	1	$-40 \pm 0/-2$	15 ± 1	2	Room Temperature	Within ≤ 0.2	3	$+125 \pm 2/-0$	15 ± 1
Step		Temperature ($^{\circ}\text{C}$)	Times (min.)											
1		$-40 \pm 0/-2$	15 ± 1											
2		Room Temperature	Within ≤ 0.2											
3		$+125 \pm 2/-0$	15 ± 1											
Humidity Resistance	Temperature : $85 \pm 2^{\circ}\text{C}$ Humidity : $85 \pm 3\%$ RH Time : 1000 ± 12 hours Measured at room temperature after placing for 2 to 3hrs (AEC-Q200-REV C)													
Vibration Test	Frequency : 10-2000-10Hz for 20min. Amplitude: Parts mounted within 2" from any secure point. Directions and times : X, Y, Z directions for 20 min. This cycle shall be performed 12 times in each of three mutually perpendicular directions. (Total 12 hours) (MIL-STD-202 Method 204 D Test condition B)													
Reflow Test	Preheat : $150 \pm 5^{\circ}\text{C}$ Duration : 5 minutes Temperature : $260 \pm 5^{\circ}\text{C}$, 20-40 seconds (IPC/JEDEC J-STD-020C)													
Solder test	Terminals should be covered by over 95% solder on visual inspection.	After dip into flux, dip into solder $235 \pm 5^{\circ}\text{C}$, 4 ± 1 seconds Flux, solder for lead free (ANSI/J-STD-002C Method B)												



LM1265HP Series SMD Power Inductors (RoHS Compliant)



9. SOLDERING AND MOUNTING :

9-1. Recommended PC Board Pattern

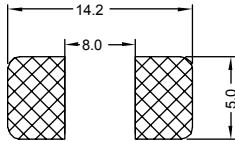

9-2. Soldering

Mildly activated rosin fluxes are preferred. The minimum amount of solder can lead to damage from the stresses caused by the difference in coefficients of expansion between solder, chip and substrate. Our terminations are suitable for all wave and re-flow soldering systems. If hand soldering cannot be avoided, the preferred technique is the utilization of hot air soldering tools.

9-2.1 Solder Re-flow :

Recommended temperature profiles for re-flow soldering in Figure 1.

9-2.2 Soldering Iron (Figure 2) :

Products attachment with soldering iron is discouraged due to the inherent process control limitations. In the event that a soldering iron must be employed the following precautions are recommended.

Note :

- Preheat circuit and products to 150° C.
- 355° C tip temperature (max)
- Never contact the ceramic with the iron tip
- 1.0mm tip diameter (max)
- Use a 20 watt soldering iron with tip diameter of 1.0mm
- Limit soldering time to 4~5 secs.

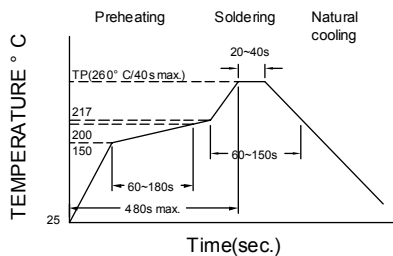

Figure 1. Re-flow Soldering: 3 times max.

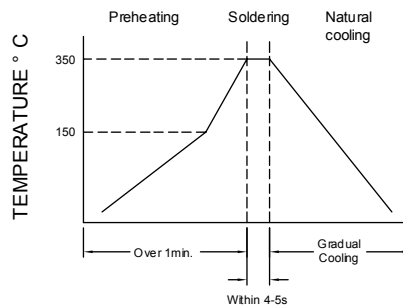

Figure 2. Hand Soldering: 1 times max.



LM1265HP Series SMD Power Inductors (RoHS Compliant)

10. PACKAGING INFORMATION :

10-1. Reel Dimension

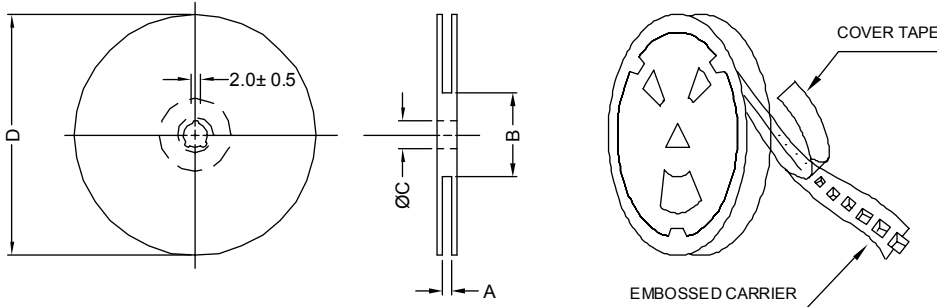

Type	A(mm)	B(mm)	C(mm)	D(mm)
13" x 24mm	24.0 ± 0.5	100 ± 2.0	13.5 ± 0.5	330

10-2 Tape Dimension

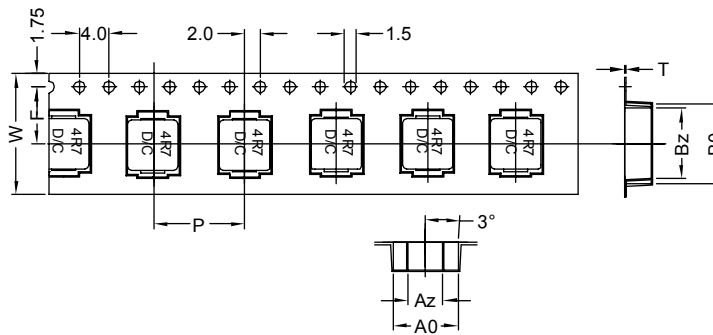

Series	Ao(mm)	Az(mm)	Bo(mm)	Bz(mm)	Ko(mm)	P(mm)	W(mm)	F(mm)	t(mm)
LM1265	12.9 ± 0.1	7.0 ± 0.1	14.1 ± 0.1	13.0 ± 0.1	7.0 ± 0.1	16.0 ± 0.1	24 ± 0.3	11.5 ± 0.1	0.35 ± 0.05

10-3. Packaging Quantity

Size	LM1265
Chip / Reel	500
Inner Box	1000
Carton	4000

LM1265HP Series SMD Power Inductors (RoHS Compliant)



10-4. Tearing Off Force

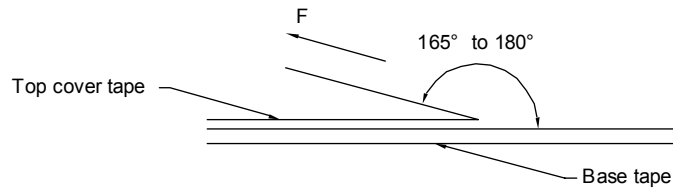

The force for tearing off cover tape is 10 to 130 grams in the arrow direction under the following conditions. (referenced ANSI/EIA-481-C-2003 of 4.11 standard)

Room Temp. (° C)	Room Humidity (%)	Room atm (hPa)	Tearing Speed (mm/min)
5~35	45~85	860~1060	300

Application Notice

1. Storage Conditions :

To maintain the solderability of terminal electrodes :

- Temperature and humidity conditions : Less than 30° C and 70% RH.
- Recommended products should be used within 6 months from the time of delivery.
- The packaging material should be kept where no chlorine or sulfur exists in the air.

2. Transportation :

- Products should be handled with care to avoid damage or contamination from perspiration and skin oils.
- The use of tweezers or vacuum pick up is strongly recommended for individual components.
- Bulk handling should ensure that abrasion and mechanical shock are minimized.

