

## HEQB-25A-48V-1.8V

### 48V<sub>in</sub> 25A<sub>out</sub> 1.8V<sub>out</sub> High Efficiency, Isolated Quarter Brick DC-DC Converter



#### Features

- Very high efficiency: 88.5%
- Wide input voltage range (36 to 75Vdc)
- Low profile, industry standard footprint and pin out:  
2.3" x 1.45" x 0.36" (58.4mm x 36.8mm x 9.35mm)
- Total weight: 34g. (1.2oz.)
- Remote ON/OFF
- Output voltage trim
- Remote sense
- Fixed Frequency (Input-Output ripple 400 KHz)
- Under voltage lockout (UVLO) – auto recover
- Over voltage protection – auto recover
- Over current protection – auto recover
- Over temperature protection – auto recover
- Operating temperature -40/+100°C
- Input to Output Isolation at 2000Vdc, 10MΩ
- CSA/US, CSA, TUV and KEMA Certified
- ISO 9001 Certified manufacturing processes

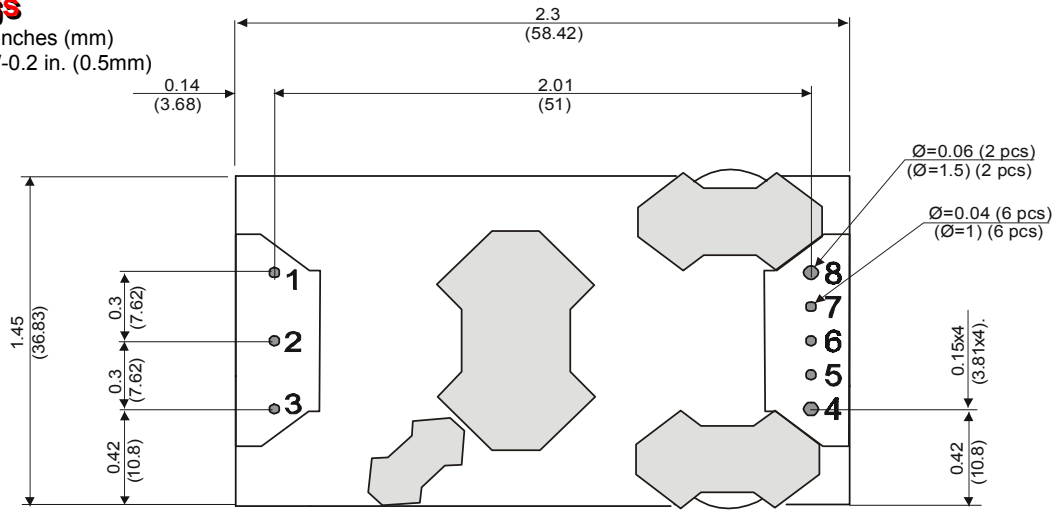


#### Product Highlights

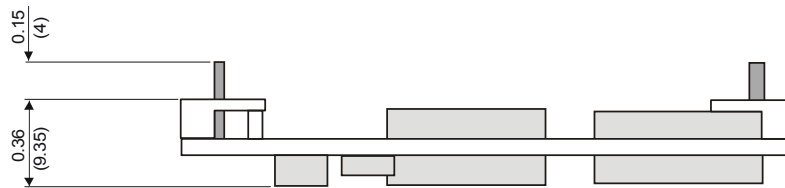
- HEQB Family of dc-dc converters is Magnetek's solution for next generation, cutting-edge board applications.
- Synchronous rectification uses MOSFET instead of Schottky diodes providing extreme reduction in heat generation, boosting efficiency, eliminating the need for a heat sink and increased reliability.
- Low profile (0.36"), open frame construction allows smaller card pitch and improves system ventilation.
- Fixed switching frequency provides predictable EMI characteristics.

## Mechanical Drawings

- All dimensions are in inches (mm)
- Tolerances: x.xx in. +/-0.2 in. (0.5mm)



**Bottom View**



PINOUT Description		
Pin	Name	Function
1	Vin (-)	Negative terminal for the input bus
2	ON/OFF	External input signal, TTL. Output voltage ON or OFF
3	Vin (+)	Positive terminal for the input bus
4	Vout (+)	Positive terminal for output voltage
5	Sense (+)	Positive remote sense
6	TRIM	Output voltage TRIM
7	Sense (-)	Negative remote sense
8	Vout (-)	Return terminal for output voltage

## Specifications

(Typical value standard at nominal input line, full load, airflow 300 LFM, 25°C ambient temperature unless otherwise specified)

Input Characteristics	Notes & Conditions	Min	Typ	Max	Units
Operating Input Voltage Range	Note 1	36	48	75	V
Input Under-Voltage Lockout					
<i>Turn-On Voltage Threshold</i>		34.3	34.8	35.4	V
<i>Turn-Off Voltage Threshold</i>		33.8	34.3	34.8	V
<i>Lockout Hysteresis Voltage</i>		0.4	0.5	0.6	V
Maximum Input Current ( $I_{INmax}$ )	$V_{IN}=36V$ ; Full Load			1.45	A
No-load Input Current			40	60	mA
Off Converter Input Current			4	6	mA
Inrush Current Transient Rating			0.01		A <sup>2</sup> s
Input Reflected-Ripple Current	RMS; See figures 1, 2		3		mA

**NOTE 1:** Absolute max. input voltage 80V

Output Characteristics	Notes & Conditions	Min	Typ	Max	Units
Output Voltage Set Point	50% Load	1.757	1.8	1.803	V
Output Voltage Regulation					
<i>Load</i>	$V_{nom} = 48V$		± 2	± 5	mV
<i>Line</i>	$I = 15A$		± 2	± 5	mV
<i>Temperature</i>			± 10	± 20	mV
Total Output Voltage Range		1.775		1.825	V
Output Voltage Ripple and Noise	20 MHz bandwidth				
<i>Peak to Peak</i>	Full load;		48	100	mV
<i>RMS</i>	see figure 1, 4		13	20	mV
Operating Output Current Range		0	-	25	A
Output DC Current Limit Inception		26	27	29	A
Output DC Current Limit Shutdown Voltage	See figure 5	1.44	1.47	1.53	V
Admissible Output Capacitance	Full load, resistive	0		20.000	μF

Dynamic Characteristics	Notes & Conditions	Min	Typ	Max	Units
Output Voltage Current Transient	470μF load cap, 1A/μs; figures 8, 9				
<i>Positive Step Change</i>	50% $I_o$ to 75% $I_o$		150		mV
<i>Negative Step Change</i>	75% $I_o$ to 50% $I_o$		150		mV
<i>Settling Time to 1%</i>			200		μs
Turn-On Transient	Figures 6 and 7				
<i>Overshoot</i>			0		%
<i>Turn-On Time</i>	Full load		15	25	ms
<i>Start-Up Inhibit Period</i>			120		ms

Efficiency	Notes & Conditions	Min	Typ	Max	Units
100% Load	$V_{IN} = 48V$		88.5		%
80% Load	$V_{IN} = 48V$		89		%
56% Load	$V_{IN} = 48V$		89		%

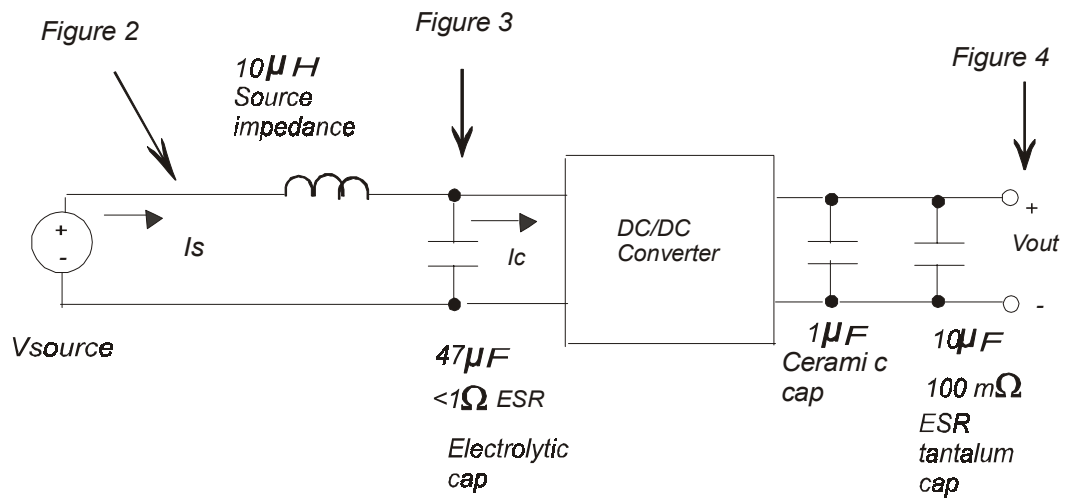
Isolation Characteristics	Notes & Conditions	Min	Typ	Max	Units
Isolation Voltage input - output	Basic Isolation		2000		V <sub>DC</sub>
Isolation Capacitance	Basic Isolation		2200		pF
Isolation Resistance		10			MΩ

Feature Characteristics		Notes & Conditions	Min.	Typ.	Max	Units
Switching frequency		Double Frequency for Input-Output Ripple	190	200	210	kHz
ON/OFF Control						
Off-State Voltage			2.7		10	V
On-State Voltage			0		0.8	V
Output Voltage Trim Range			-10		+10	%
Output Voltage Remote Sense Range					+10	%
Output Over-Voltage Protection			115	119	123	%
Overcurrent Protection Threshold			26-35 A			
Over-Temperature shutdown		Average PCB temperature		125		°C

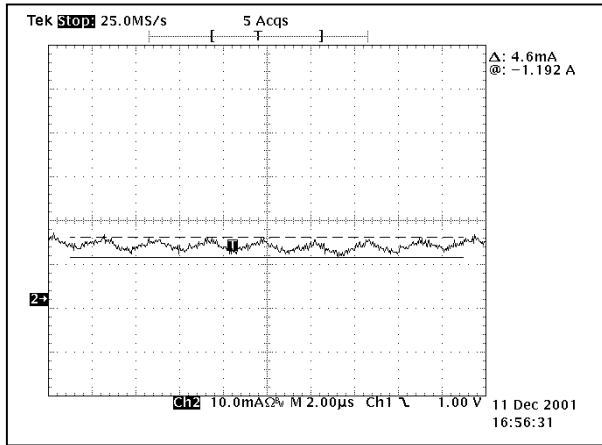
General Characteristics		Notes & Conditions	Min	Typ	Max	Units
Operating Range Temperature		Maximum Rating	-40		+100	°C
Storage Temperature		Maximum Rating	-50		+120	°C
Relative Humidity		Non condensing	5		95	%
Calculated MTBF		Bellcore Issue 4 RDF93 HRD Issue 5	Min. 1,500,000 hours			

Safety and Regulatory	
TUV and KEMA certified for compliance to EN06950 requirements	
CSA 22.2 No. 950-95(US and Canada) certified with basic insulation for compliance to UL 1950.	
Note : An external input fuse must always be used for compliance to listed safety requirements.	
CE compliant per 72/23/EEC (Low voltage directive) and 93/68/EEC to facilitate CE Mark at system level.	
Material flammability rating, UL94V-0	
NEBS compliant	

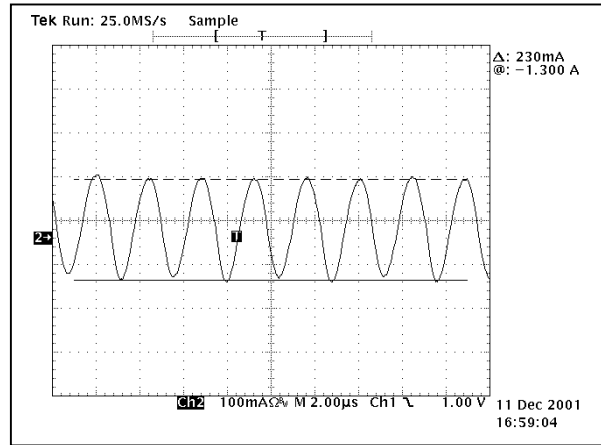
## Characteristic Curves



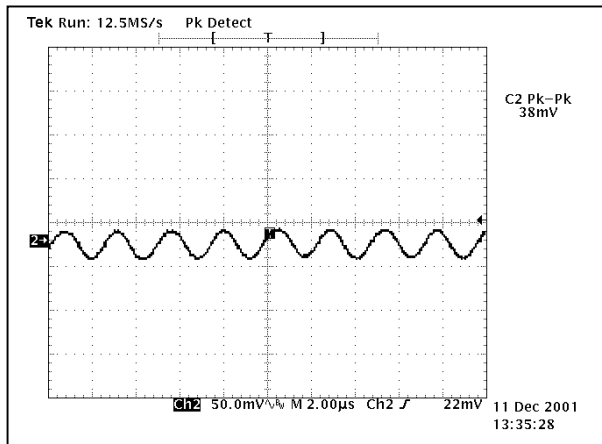
**FIGURE 1:** Set-up diagram showing measurement points for: Input Terminal Ripple Current, Input Reflected Ripple Current and Output Voltage Ripple



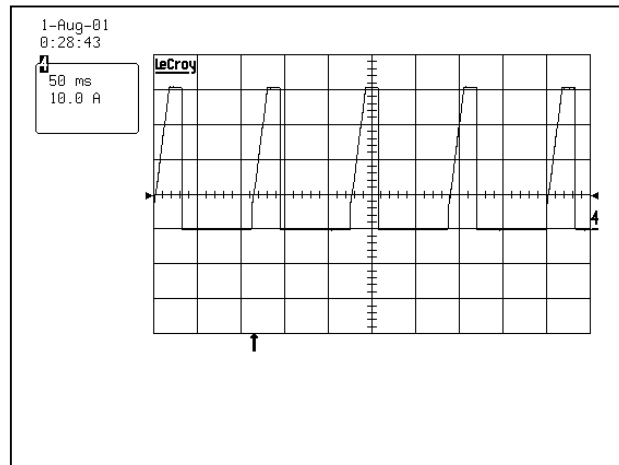
**FIGURE 2:** Input Reflected Ripple Current, set-up per figure 1; 10µH source impedance. Nominal input voltage at full rated load.



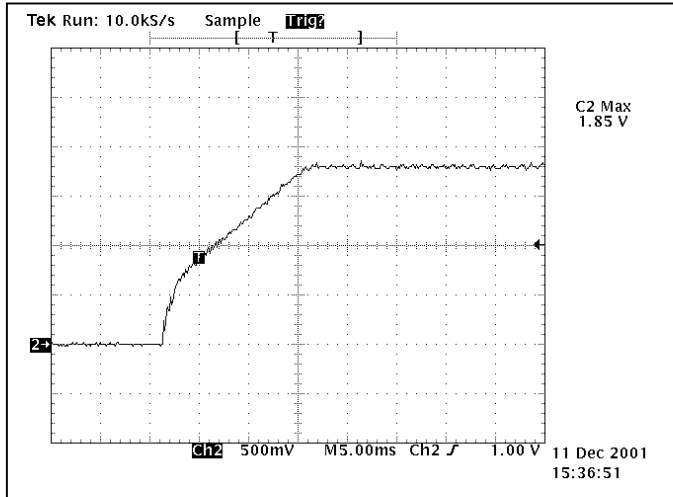
**FIGURE 3:** Input Terminal Ripple Current, set-up per figure 1; 10µH source impedance and 47µF electrolytic capacitor. Nominal input voltage at full rated load.



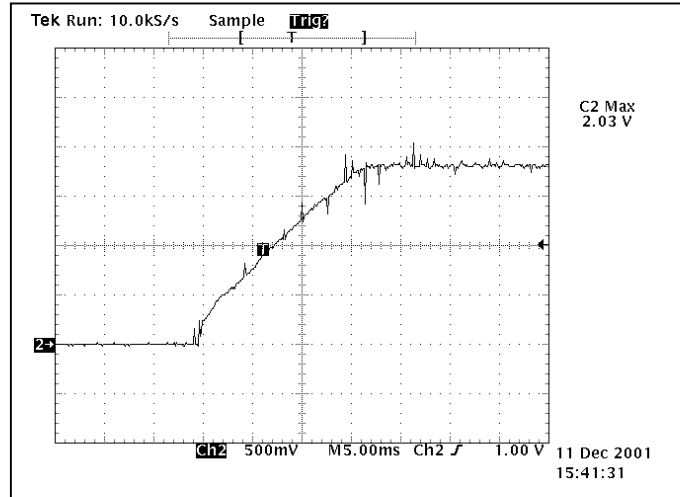
**FIGURE 4:** Output Voltage Ripple, set-up per figure 1; 1µF ceramic capacitor and 10µF tantalum capacitor. Nominal input voltage at full rated load



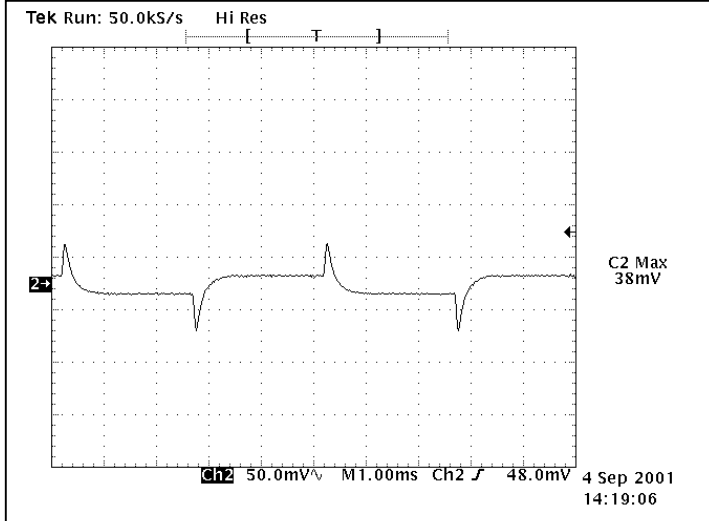
**FIGURE 5:** Load current as a function of time while attempting to enable into a short circuit, <10mΩ.



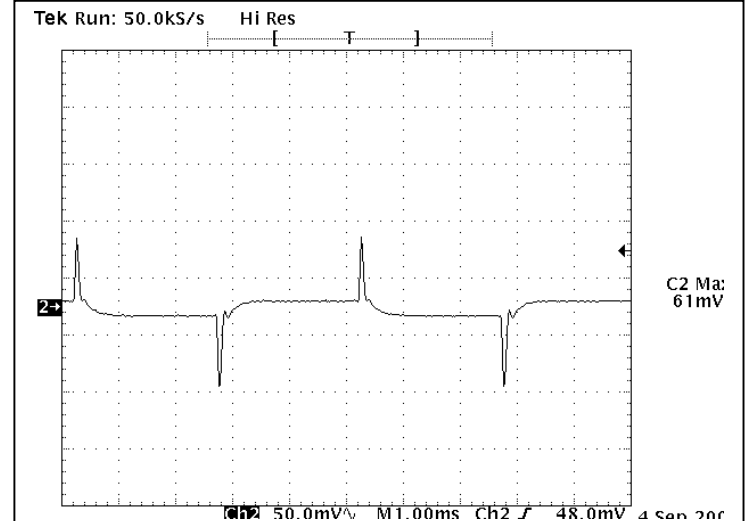
**FIGURE 6:** Turn-on transient at full rated load.



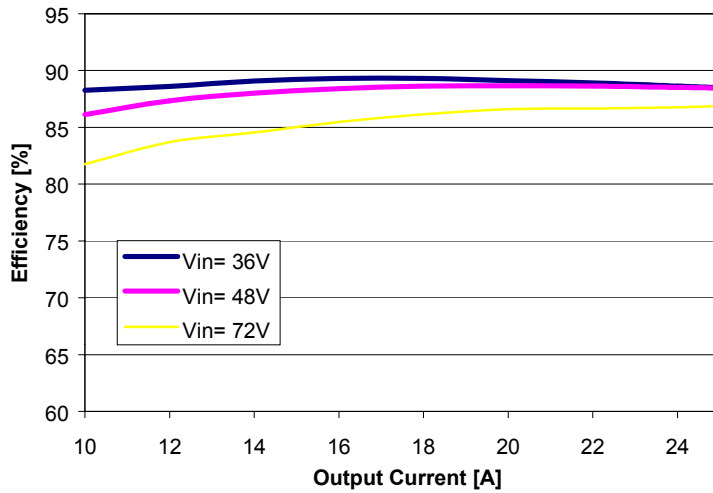
**FIGURE 7:** Turn-on transient at zero load.



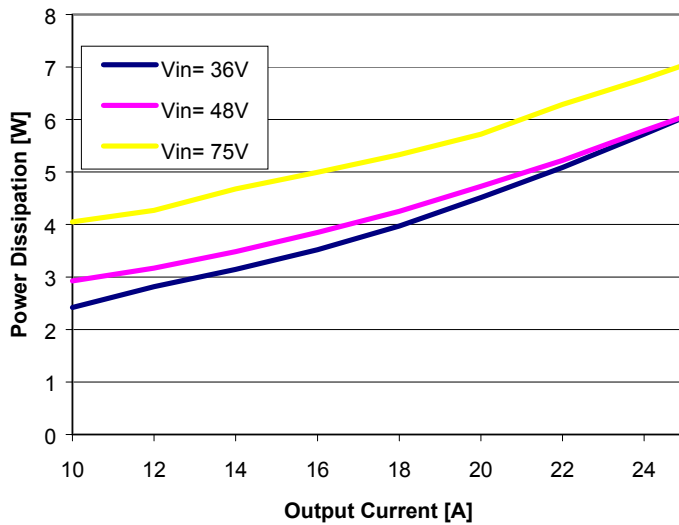
**FIGURE 8:** Output voltage response to dynamic change in load current:  $75\% I_o$  to  $50\% I_o$ , where  $di/dt = 0.1A/\mu s$   
 Load cap:  $10\mu F$ ,  $100\ m\Omega$  ESR tantalum capacitor and  $1\mu F$  ceramic capacitor



**FIGURE 9:** Output voltage response to step-change in load current.  $50\% I_o$  to  $75\% I_o$ , where  $di/dt = 1A/\mu s$   
 Load cap:  $470\mu F$ ,  $30\ m\Omega$  ESR tantalum capacitor and  $1\mu F$  ceramic capacitor

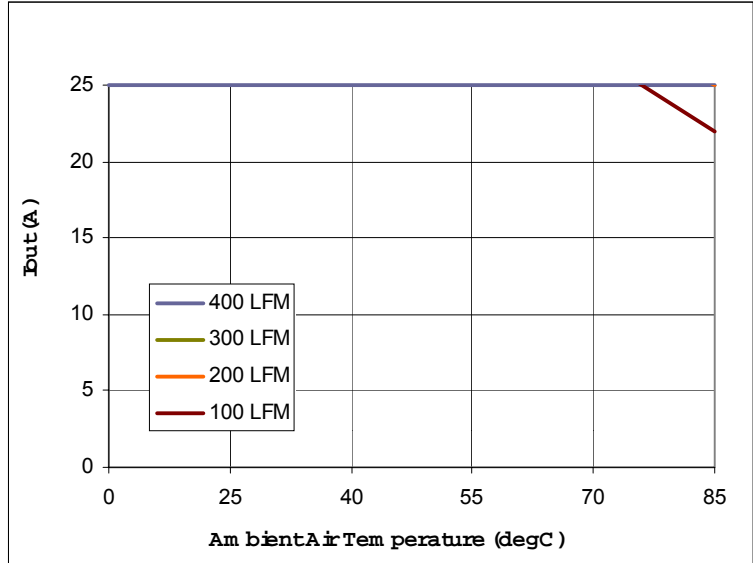


**FIGURE 10:** Efficiency vs. load current for different input voltages at 25°C

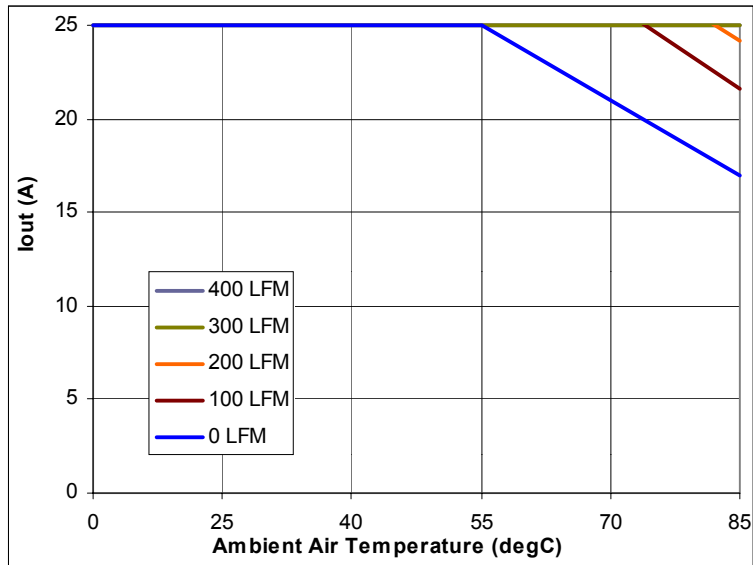


**FIGURE 11:** Power dissipation vs. load current for different input voltages at 25°C

**FIGURE 12:** Maximum output current derating curves vs. ambient air temperature. Airflow rates of 100 LFM through 400 LFM with air flowing across (Transversal) the converter from pin 1 to pin 3 at nominal input voltage.



**FIGURE 13:** Maximum output current derating curves vs. ambient air temperature. Airflow rates of 0 LFM through 400 LFM with air flowing across the converter from output to input at nominal input voltage.



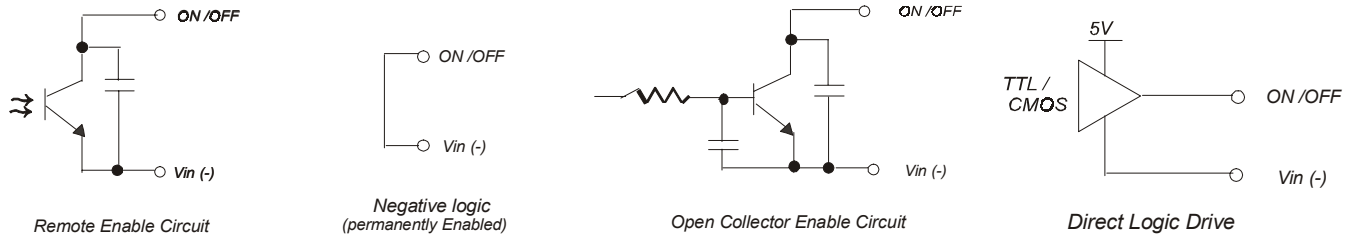


# HEQB-25A-48V-1.8V

## Features and Pins description

### REMOTE ON-OFF CONTROL

The default logic is negative, where the Remote On/Off (pin 2) input is referenced to -Vin (pin 1). The Remote On/Off signal must be lower than 0.8V to enable the output voltage, and higher than 2.7V to disable the output voltage. Positive logic is an available option, add “-P” to the end of the ordering code.

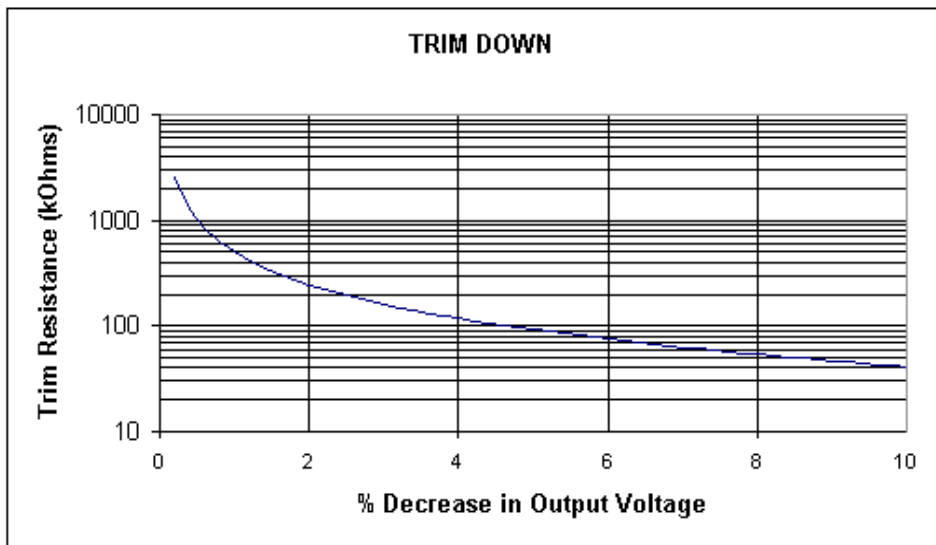


### TRIM

The output voltage can be trimmed by means of an external resistor connected between Trim (pin 6) and +Sense (pin 5) or -Sense (pin 7). The selection of the resistor follows the industry standard trim equation.

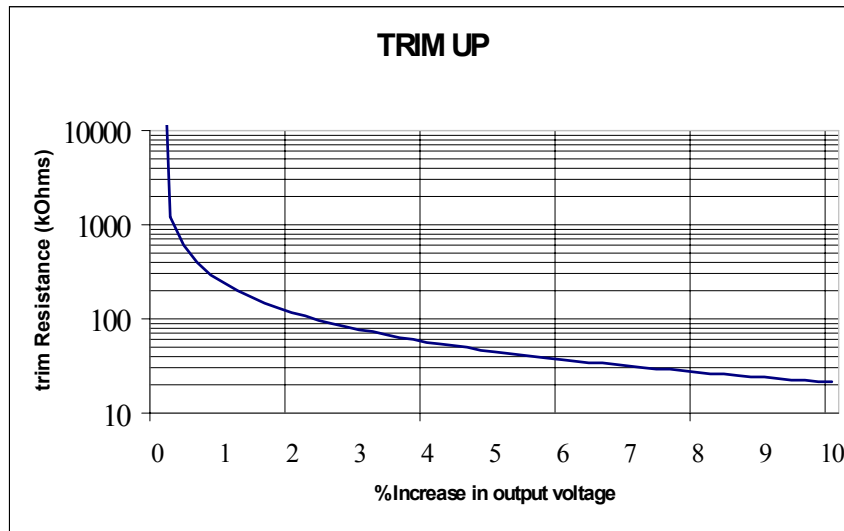
An external resistor connected between Trim and -Sense pins will decrease the output voltage. For a decrease of  $\Delta\%$  of the nominal output voltage, calculate the value of the external resistor using the following equation:

$$R_{\text{trim-down}} = \left( \frac{511}{\Delta\%} \right) - 10.22k\Omega \quad \text{where} \quad \Delta = \left( \frac{1.8 - V_{\text{target}}}{1.8} \right) \times 100\%$$



A resistor connected between Trim and + S pins will increase the output voltage. For a desired increase of  $\Delta\%$  of the nominal output voltage, the value of the resistor should be:

$$R_{\text{trim-up}} = \left( \frac{5.11 * 1.8 (100 + \Delta\%)}{1.225\Delta\%} - \frac{511}{\Delta\%} - 10.22 \right) K\Omega$$



### SENSE (+ or -)

The +Sense or -Sense pins must be connected to the load or output pins of the converter. To ensure tight regulation at the system critical load, then the remote sense pins should be connected to the system critical load. Reference applicable section of data sheet for maximum voltage compensation.

Ensure sufficient margin to the over voltage threshold, review applicable sections of the data sheet and system loading: output over-voltage protection -vs- system transient load condition(s).

# HEQB-25A-48V-1.8V

## THERMAL CONSIDERATIONS

The converter has internal thermal protection preventing hot spots on PCB from exceeding MFR’s recommended temperatures for reliable operation, reference over temperature protection threshold (Section: Feature Characteristics). Margin to the temperature protection limit should be verified in the application, and should not exceed 120°C on the thermal reference points as shown in Figure 14.

During an abnormal condition inducing an increase in the converter temperature, the converter output voltage will fold back when the over temperature protection threshold is reached. The converter will auto-recover when the fault condition is corrected and time allowed for the converter to cool down.

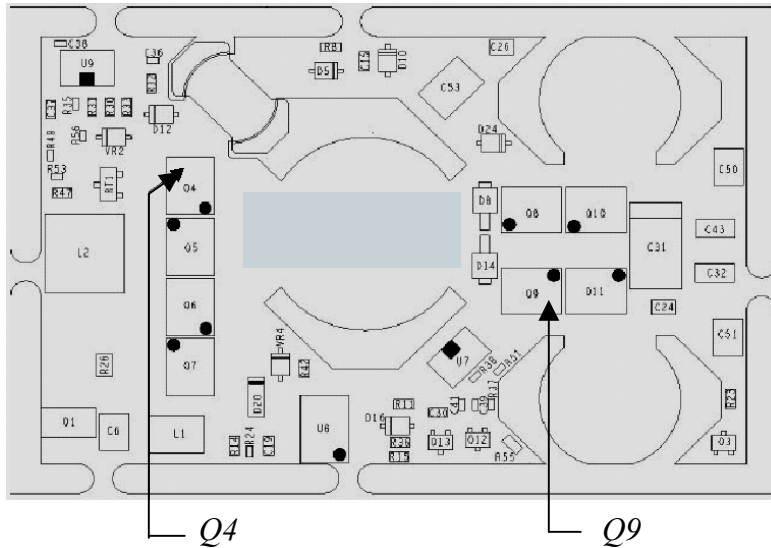


Figure 14, Thermal reference points

## OVERCURRENT PROTECTION

The overcurrent limit inception is typically 110% of the rated output current. When the overcurrent limit inception is exceeded the output voltage will decrease proportional to increase to the load current. Further increase in the load current will cause the output voltage to trip the under voltage protection threshold and enter fault protection, or hiccup reference Figure 5. The converter will enter fault protection typically at 125% of rated output current. When the fault is removed the converter will auto recover.

# HEQB-25A-48V-1.8V

Family Code	Rated Output Current	Input Voltage	Output Voltage	Option 1- Remote On/Off Logic	Option 2- Mechanical	Option 3- PIN Length
<i>HEQB</i>	<i>25A</i>	<i>48V</i>	<i>1.8V</i>	<i>Default → Negative Logic P → Positive Logic</i>	<i>Default → Open Frame PL → Cold Plate</i>	<i>Default → 0.15" 1 → 0.25" 2 → 0.11" 3 → 0.18"</i>

**Example:** HEQB-25A-48V-1.8V-PPL1, Standard quarter brick with Positive Logic, Cold Plate, and 0.25" PIN Length.

Europe  
**Magnetek PEG**  
 Via S. Giorgio 642  
 52028- Terranuova Bracciolini, Arezzo, Italy  
 Phone: (+39) 055.9195.1  
 Fax: (+39) 055.9195.248

US  
**Magnetek PEG**  
 8966 Mason Avenue  
 Chatsworth, CA 91311, USA  
 Phone: (+1) 818.727.2216  
 Fax: (+1) 818.727.2276  
 Toll-Free Number: (+1) 800.621.0733