

Zelio Analog Interface Modules

Catalog
February
06



CONTENTS

Description	Page
Product Description	3
Specifications and Characteristics	6
Selection	8
Dimensions, Mounting Instructions, Wiring Diagrams	10
Catalog Number Index	11



The Zelio Analog range of converters is designed to convert signals emitted by sensors or electrical measurement devices, into standard electrical signals that are compatible with automation platforms and controllers (thermal processes, speed, etc.). They also allow the connection distance between a sensor and a measurement acquisition device to be increased, for example, between a thermocouple and a programmable controller.

These converters are suitable for universal use, as they are UL listed, CSA certified, and conform to IEC standards.

Measurement Signals for Thermocouples and Pt100 Probes

The voltages induced by thermocouples vary between 10 and 80 $\mu\text{V}/^\circ\text{C}$. Pt100 probes (100 ohms at 0 $^\circ\text{C}$) produce about 0.5 $\text{mV}/^\circ\text{C}$, with measurement currents of 1 mA. Depending on the sensor, the signal to be measured ranges from a few μV (thermocouple) to 250 and 700 mV for a Pt100 probe.

Therefore, it is difficult to transmit these low level signals over long electric lines without encountering problems of interference, signal reduction, or errors.

Connecting Zelio Analog converters close to the sensors resolves these problems:

- 4–20 mA current loops transmitted over a long distance are less sensitive to interference than low level voltage signals from sensors,
- signal reductions during transmission (resistance) of voltages do not occur,
- the cables used to connect the converters to process equipment (programmable controllers) are standard cables, which are more cost effective than extension cables or compensation cables suitable for low level signals for Pt100 probes or thermocouples.

The Zelio Analog Range

The Zelio Analog range was developed to work with most common applications and to ensure simplicity of installation:

- pre-set input and output scales, requiring no adjustment
- outputs protected against reverse polarity, overvoltage, and short-circuits
- 24 Vdc power supply
- sealable protective cover
- DIN rail mounting and screw mounting options
- LED indicator on the front panel
- input and output selector switches on the front panel
- output with fallback value if no input signal is present (due to failure of a sensor, for example).

The Zelio Analog converter range is divided into four families:

- Converters for J and K type thermocouples: **RMTJ/K**
- Converters for Universal Pt100 probes: **RMPT●0**
- Converters for Optimum Pt100 probes: **RMPT●3**
- Universal voltage/current converters: **RMC**.

Zelio Analog Interface Modules

Product Description

Converters for J and K type thermocouples

Thermocouples, which consist of two metals with different thermoelectric characteristics, produce a voltage that varies according to temperature. This voltage is transmitted to the Zelio Analog converter, which converts it to a standard signal.

Converters for thermocouples have cold junction compensation to allow detection of measurement errors induced by the connection to the device itself.

Converters for J and K type thermocouples have:

- for inputs, a pre-set temperature range, depending on the model:
 - Type J: 32–302 °F (0–150 °C), 32–572 °F (0–300 °C), 32–1112 °F (0–600 °C)
 - Type K: 32–1112 °F (0–600 °C), 32–2192 °F (0–1200 °C).
- for outputs, a switchable signal:
 - 0–10 V, 0–20 mA, 4–20 mA.



Converters for Universal Pt100 Probes

Pt100 probes with platinum resistors are electrical conductors whose resistance varies according to the temperature. This ohmic resistance is transmitted to the Zelio Analog converter, which converts it to a standard signal.

Converters for Universal Pt100 probes have:

- for inputs, a pre-set temperature range, depending on the model:
 - -148–212 °F (-100 to 100 °C),
 - -40–104 °F (- 40 to 40 °C),
 - 32–212 °F (0 to 100 °C),
 - 32–482 °F (0 to 250 °C),
 - 32–932 °F (0 to 500 °C).
- for outputs, a switchable signal:
 - 0–10 V, 0–20 mA, 4–20 mA.

The products in the Universal Pt100 family allow wiring of Pt100 probes in 2, 3, and 4-wire mode.

Converters for Optimum Pt100 Probes

Derived from the above family, these converters have:

- for inputs, a pre-set temperature range identical to that of converters for Universal Pt100 probes.
- for outputs, 0–10V signal dedicated to Zelio Logic analog inputs.

They allow Pt100 probes to be wired in 2, 3, and 4-wire mode.



Universal Voltage/Current Converters

This family of converters allows the adaptation of electrical values (voltage/current). Four products are available:

- a cost effective converter which will convert a 0–10 V signal to a 4–20mA signal, or vice versa.
- a Universal voltage/current converter allowing the most common signals. They have:
 - for inputs, a voltage/current range: 0–10 V, ± 10 V, 0–20 mA, 4–20 mA.
 - for outputs, a switchable voltage/current range: 0–10 V, ± 10 V, 0–20 mA, 4–20 mA.
- two Universal voltage/current converters which allow conversion of electrical power signals, both AC and DC.

They have the following, depending on the model:

- **for voltage inputs**, a range of 0–500 V (AC or DC)
- for outputs, a switchable voltage/current range: 0–10 V, 0–20 mA, 4–20 mA.
- **for current inputs**, a range of 0–15 A (AC or DC)
- for outputs, a voltage/current range: 0–10 V, 0–20 mA, 4–20 mA.

Description

Zelio Analog converters have the following on their front panel, depending on the model:

1. Two terminals for 24 Vdc supply connection
2. A “Power ON” LED
3. Three input selector switches (depending on model)
4. An output selector switch (depending on model)
5. A sealable protective cover
6. A screw terminal block for inputs
7. A screw terminal block for outputs.



RMCA61BD

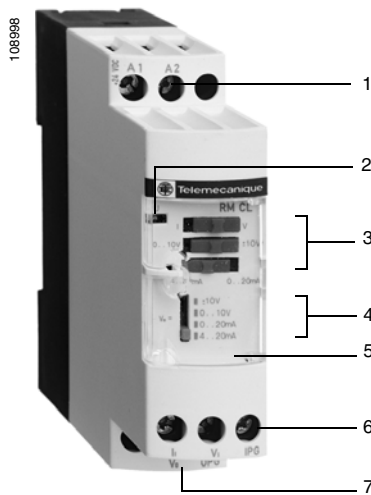

RMCL55BD

Zelio Analog Interface Modules Specifications and Characteristics

Environmental Characteristics

Converter Types	RMTJ/K●●●●●, RMP●●●●●, RMC●●●●●
Conforming to Standards	IEC 60947-1, IEC 60584-1 (IEC 60751, DIN 43760 for RMP●●●●●)
Product Certifications	UL Listed, File E164353 NKCR; CSA Certified, File 089150_S_000, Class 3211-07; C€; GL
Degree of Protection	
Housing	IP 50
Terminal block	IP 20
Flame Resistance	1562 °F (850 °C) conforming to UL, IEC 60695-2-1
Shock Resistance	50 gn/11 ms conforming to IEC 68-2-27
Vibration Resistance	5 gn (10–100 Hz) conforming to IEC 68-2-6
Immunity to EMC	
Resistance to electrostatic discharge	Level 3: 8 kV (air), 6 kV (contact) conforming to IEC 61000-4-2
Immunity to fast transient currents	On the power supply: 2 kV; on the input-output: 1 kV conforming to IEC 61004-4
Surge withstand	0.5 kV - waves 1.2/50 µs; 0.5 J conforming to IEC 61000-4-5
Disturbance	
Radiated/conducted	CISPR11 and CISPR22 Group 1- Class B
Insulation Voltage	2
Ambient Air Temperature Around the Device	
Storage	-40–185 °F (-40–85 °C)
Operation	Mounted side-by-side: 32–122 °F (0–50 °C); 2 cm spacing: 32–140 °F (0–60 °C)
Degree of Pollution	2 conforming to IEC 60664-1
Mounting	35 mm DIN rail, clip-on, or mounted directly to a panel
Connection	2-16 AWG or 1-14 AWG wire (2 x 1.5 mm ² or 1 x 2.5 mm ² cable)
Tightening Torque	5.3–9.8 lbf-in (0.6–1.1 N●m)

Specific Characteristics

Types of converter for thermocouples		RMTJ40BD	RMTJ60BD	RMTJ80BD	RMTK80BD	RMTK90BD
Input Types	Thermocouple type to IEC 60584	J (Fe-CuNi)			K (Ni-CrNi)	
	Temperature range	32–302 °F 0–150 °C	32–572 °F 0–300 °C	32–1112 °F 0–600 °C	32–1112 °F 0–600 °C	32–2192 °F 0–1200 °C
Analog Output (switchable to voltage or current)						
Voltage	Range	0–10 V				
	Minimum impedance of load	100 kΩ				
Current	Range	0–20 mA; 4–20 mA				
	Maximum impedance of load	500 Ω				
Built-in protection		Reverse polarity, Overvoltage (± 30 V), and Short-circuit				
Safety	Output state when no inputs are wired or when input wire broken	Output predetermined according to type of output selected: voltage = - 13 V current = 0 mA				
Supply						
Voltage	Rated	24 Vdc ± 20 %, non-isolated				
Maximum current consumption	For voltage output	40 mA				
	For current output	60 mA				
Built-in protection		Reverse polarity				
Signalling		Green LED (power on)				
Measurements						
Accuracy	At 68 °F (20 °C)	± 1% of the full scale value ± 10 % of the full-scale value (in an environment subject to electromagnetic interference of 10 V/m)				
Repeat accuracy	At 68 °F (20 °C)	± 0.25 % of the full scale value				
	At 140 °F (60 °C)	± 0.8 % of the full scale value				
Temperature coefficient		200 ppm/°C (0.02 %)				
Cold junction compensation		Built-in, cold junction measurement: 0–140 °F (0 to 60 °C)				

Zelio Analog Interface Modules Specifications and Characteristics

Specific characteristics (continued)

Converter for Pt100 Probes		RMPT10/13BD	RMPT20/23BD	RMPT30/33BD	RMPT50/53BD	RMPT70/73BD
Input Types	Probe type	Pt100 - IEC 60751; DIN 43760 (2, 3, 4-wire)				
	Temperature range	- 40–104 °F - 40–40 °C	- 148–212 °F - 100–100 °C	32–212 °F 0–100 °C	32–482 °F 0–250 °C	32–932 °F 0–500 °C
Analog Output						
Output selection		0–10 V/0–20 mA, 4–20 mA switchable for RMPT●0BD 0–10 V or 4–20 mA for RMPT●3BD				
Voltage	Minimum impedance of load	100 kΩ				
Current	Maximum impedance of load	500 Ω				
Built-in protection		Reverse polarity, Overvoltage (± 30 V), and Short-circuit				
Safety	Output state when no inputs are wired or when input wire broken	Output predetermined according to type of output selected: voltage = - 13 V current = 0 mA				
Supply						
Voltage	Rated	24 Vdc ± 20 %, non-isolated				
Maximum current consumption	For voltage output	40 mA				
	For current output	60 mA				
Built-in protection		Reverse polarity				
Signalling		Green LED (power on)				
Measurements						
Accuracy	At 68 °F (20 °C)	± 0.5 % (3 and 4-wire connection) of the full scale value ± 1 % (2-wire connection) of the full scale value ± 10 % of the full-scale value (in an environment subject to electromagnetic interference of 10 V/m)				
	At 140 °F (60 °C)	± 0.6 % of the full scale value				
Repeat accuracy	At 68 °F (20 °C)	± 0.2 % of the full scale value				
	At 140 °F (60 °C)	± 0.6 % of the full scale value				
Temperature coefficient		150 ppm/°C (0.015 %)				
Connection in 2-wire mode						
Maximum resistance of cable		200 mΩ				
Voltage/Current Converters		RMCN22BD	RMCL55BD	RMCV60BD	RMCA61BD	
Input Types	Voltage	0–10 Vdc	0–10, ±10 Vdc	0–50; 0–300; 0–500 DC or AC 50/60 Hz	–	
	Current	4–20 mA	0–20 mA ; 4–20 mA	–	–	
Analog Output						
Output selection		By wiring	Switchable	Switchable	By wiring	
Voltage	Range	0–10 V	0–10 V ; ± 10	0–10 V	0–10 V	
	Minimum impedance of load	100 kΩ				
Current	Range	4–20 mA	0–20 mA ; 4–20 mA	0–20 mA ; 4–20 mA	0–20 mA ; 4–20 mA	
	Maximum impedance of load	500 Ω				
Built-in protection		Reverse polarity, overvoltage (± 30 V) and short-circuit				
Safety	Output state when no inputs are wired or when input wire broken	Output predetermined according to type of output selected: voltage: < 0 V current: < 4 mA				
Supply						
Voltage	Rated	24 Vdc ± 20 % non-isolated	24 Vdc ± 20 % isolated (1.5 kV)			
Maximum current consumption	For voltage output	40 mA	70 mA			
	For current output	60 mA	90 mA			
Built-in protection		Reverse polarity				
Signalling		Green LED (power on)				
Measurements						
Accuracy	At 68 °F (20 °C)	± 1 % of the full scale value ± 10 % of the full-scale value (in an environment subject to electromagnetic interference of 10 V/m)			± 5 % of the full scale value ± 10 % of the full-scale value (in an environment subject to electromagnetic interference of 10 V/m)	
	At 140 °F (60 °C)	± 0.6 % of the full scale value				
Repeat accuracy	At 68 °F (20 °C)	± 0.2 % of the full scale value				
	At 140 °F (60 °C)	± 0.6 % of the full scale value				
Temperature coefficient		200 ppm/°C (0.02 %)			0–1.5 A: 500 ppm/°C (0.05 %) 0–5 A: 1000 ppm/°C (0.1 %) 0–15 A: 2000 ppm/°C (0.2 %)	

Zelio Analog Interface Modules Selection

Converters for J and K type thermocouples—Supply voltage 24 Vdc ± 20 %, non-isolated

Type	Temperature Range		Switchable Output Signals	Catalog Number	Weight	
	°F	°C			lb	kg
Type J	32–302	0–150	0–10 V, 0–20 mA, 4–20 mA	RMTJ40BD	0.264	0.120
	32–572	0–300	0–10 V, 0–20 mA, 4–20 mA	RMTJ60BD	0.264	0.120
	32–1112	0–600	0–10 V, 0–20 mA, 4–20 mA	RMTJ80BD	0.264	0.120
Type K	32–1112	0–600	0–10 V, 0–20 mA, 4–20 mA	RMTK80BD	0.264	0.120
	32–2192	0–1200	0–10 V, 0–20 mA, 4–20 mA	RMTK90BD	0.264	0.120



RMTJ40BD



RMTK90BD

Converters for Universal Pt100 probes—Supply voltage 24 Vdc ± 20 %, non-isolated

Type	Temperature Range		Switchable Output Signals	Catalog Number	Weight	
	°F	°C			lb	kg
Pt100 2-wire, 3-wire, and 4-wire	- 40–104	- 40–40	0–10 V, 0–20 mA, 4–20 mA	RMPT10BD	0.264	0.120
	- 148–212	- 100–100	0–10 V, 0–20 mA, 4–20 mA	RMPT20BD	0.264	0.120
	32–212	0–100	0–10 V, 0–20 mA, 4–20 mA	RMPT30BD	0.264	0.120
	32–482	0–250	0–10 V, 0–20 mA, 4–20 mA	RMPT50BD	0.264	0.120
	32–932	0–500	0–10 V, 0–20 mA, 4–20 mA	RMPT70BD	0.264	0.120



RMPT70BD

Converters for Optimum Pt100 probes (1)—Supply voltage 24 Vdc ± 20 %, non-isolated

Type	Temperature Range		Switchable Output Signals	Catalog Number	Weight	
	°F	°C			lb	kg
Pt100 2-wire, 3-wire, and 4-wire	- 40–104	- 40–40	0–10 V or 4–20 mA	RMPT13BD	0.264	0.120
	- 148–212	- 100–100	0–10 V or 4–20 mA	RMPT23BD	0.264	0.120
	32–212	0–100	0–10 V or 4–20 mA	RMPT33BD	0.264	0.120
	32–482	0–250	0–10 V or 4–20 mA	RMPT53BD	0.264	0.120
	32–932	0–500	0–10 V or 4–20 mA	RMPT73BD	0.264	0.120



RMPT13BD

(1) Converters dedicated to Zelio Logic smart relays.

Zelio Analog Interface Modules Selection

Universal Voltage/Current Converters

Type	Input signal	Output signal	Catalog Number	Weight	
				lb	kg
Supply voltage 24 Vdc \pm 20 %, non-isolated	0–10 V or 4–20 mA	0–10 V or 4–20 mA	RMCN22BD	0.264	0.120
Supply voltage 24 Vdc \pm 20 %, isolated	0–10 V, \pm 10 V, 0–20 mA, 4–20 mA	Switchable: 0–10 V, \pm 10 V, 0–20 mA, 4–20 mA	RMCL55BD	0.264	0.120
	0–50 V, 0–300 V, 0–500 V DC or AC, 50/60 Hz	Switchable: 0–10 V, 0–20 mA, 4–20 mA	RMCV60BD	0.264	0.120
	0–1.5 A, 0–5 A, 0–15 A DC or AC, 50/60 Hz	0–10 V, 0–20 mA, 4–20 mA	RMCA61BD	0.264	0.120



RMCN22BD



RMCL55BD



RMCA61BD

Connection Accessories

Description	Type	Sold in lots of	Catalog Number	Weight	
				oz	g
Terminal blocks for connection of protective ground conductor	Screw	100	AB1TP435U	0.88	25.0
	Spring	100	AB1RRTP435U2	0.52	14.7

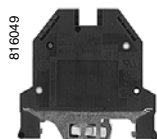

AB1TP435U

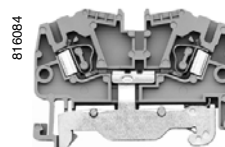

AB1RRTP435U2

Zelio Analog Interface Modules

Dimensions, Mounting Instructions, Wiring Diagrams

Dimensions, Mounting Instructions

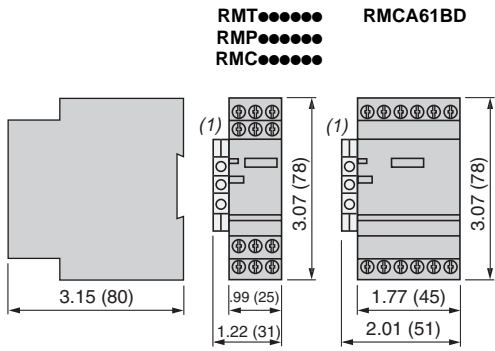

(1) Terminal block AB1 R RTP435U or AB1 R RTP435U2.

DIN Rail Mounting AM1

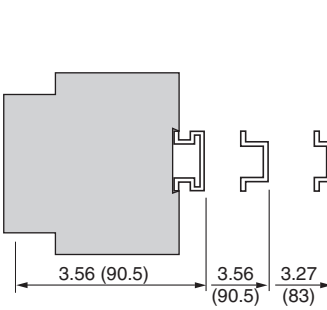

Panel mounting

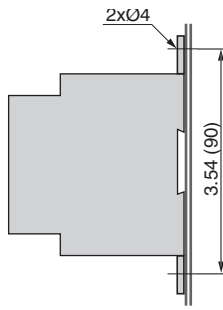

Dimensions = In. (mm)

Wiring Diagrams

RMTJ, RMTK

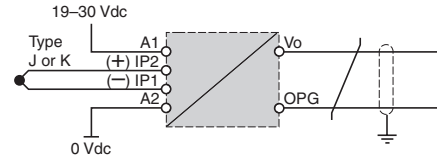

RMPT0BD

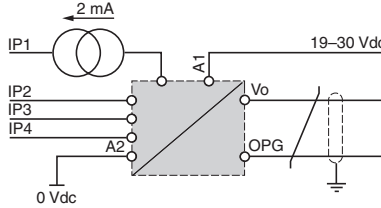

RMPT3BD

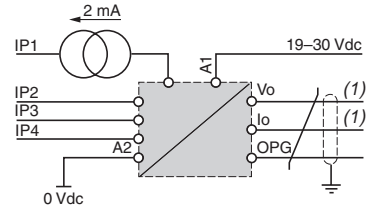

(1) Use one output only.

Input connections on RMPT

2-wire type

$$RL1 + RL2 \leq 200 \text{ m}\Omega$$

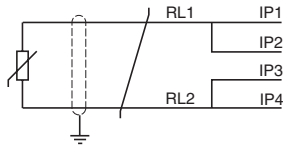

3-wire type

$$RL1 = RL2 = RL3; RL1 + RL2 \leq 200 \text{ }\Omega$$

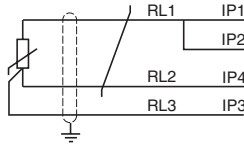

4-wire type

$$RL1 + RL2 \leq 200 \text{ }\Omega$$

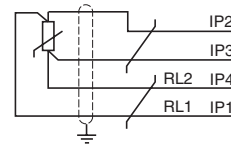

RMCN22BD

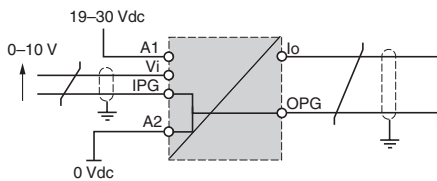
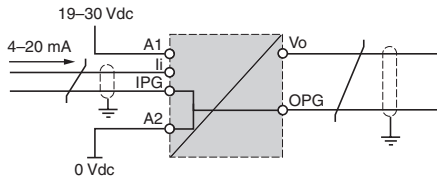

RMCL55BD

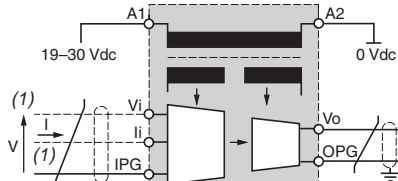

(1) Use one input only.

RMCV60BD

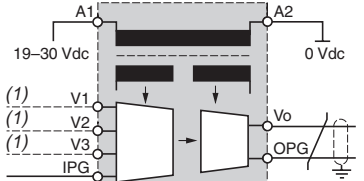

(1) Use one input only.

RMCA61BD

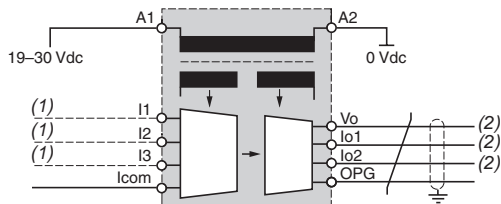

(1) Use one input only.
(2) Use one output only.

⚠ The input, output, and power supply lines must be kept away from the power cables to avoid effects due to induced interference.

The input and output cables must be shielded as indicated in the wiring diagram,s and must be kept away from each other.

Zelio Analog Interface Modules Catalog Number Index

Module	Page
RMTJ40BD	8
RMTJ60BD	8
RMTJ80BD	8
RMTK80BD	8
RMTK90BD	8
RMPT10BD	8
RMPT20BD	8
RMPT30BD	8
RMPT50BD	8
RMPT70BD	8
RMPT13BD	8
RMPT23BD	8
RMPT33BD	8
RMPT53BD	8
RMPT73BD	8
RMCL55BD	9
RMCN22BD	9
RMCV60BD	9
RMCA61BD	9
AB1TP435U	9
AB1RRTP435U2	9

Schneider Electric USA

8001 Highway 64 East
Knightdale, NC 27545
1-888-Square D
(1-888-778-2733)
www.us.SquareD.com

8501CT0502 © 2006 Schneider Electric All Rights Reserved

02/2006