

Abdeckung vorverrastet
cover loose mounted

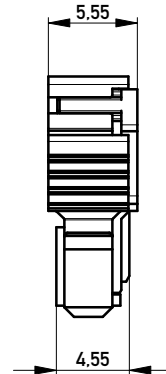

Abdeckung verpresst
cover pressed on

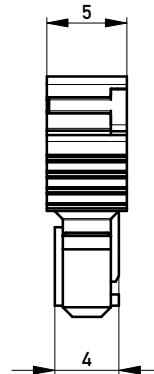

Verpackt in Tray - tray packaging
Verpackungseinheit 126 Stück - packaging unit 126

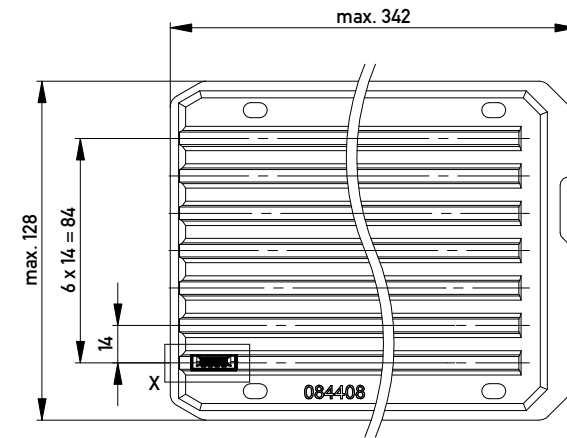

Einzelheit X
detail X

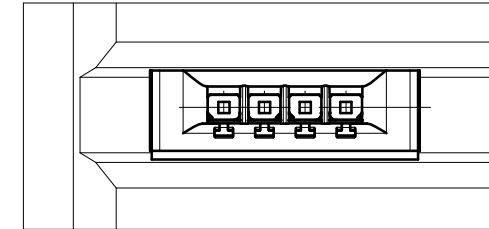

Copyright by ERNI GmbH
Proprietary notice pursuant to ISO 16949 to be observed.

Information: Codierung grün - coding green		Tolerances		Scale	3:1
All rights reserved. Only for Information. To ensure that this is the latest version of this drawing, please contact one of the ERNI companies before using.		Subject to modification without prior notice. Drawing will not be updated.		Designation F 2,54 SRC-A, 4-polig BA 2	
		www.ERNI.com		104302000001	
c	14.05.2014			K	
Index	Date			A3	
				Class	SRCBUG