

Sensitive SCRs

(0.8 – 10 Amps)

General Description

The Teccor Electronics, Inc. line of sensitive SCR semiconductors are half-wave unidirectional gate-controlled rectifiers (SCR-thyristor) which complement Teccor's line of power SCRs. This group of packages offers ratings of 0.8-10 amps, and 50-600 volts with gate sensitivities of 12-500 microamps. If gate currents in the 10-50 milliamp ranges are required, please consult Teccor's non-sensitive SCR technical data sheets.

Electrically Isolated Packages

This group of Teccor sensitive SCRs is available in a choice of three different product packages. The TO-220AB and TO-92 are electrically isolated where the case or tab is internally isolated to allow the use of low cost assembly and convenient packaging techniques.

Glass Passivation

Teccor's line of SCRs features glass-passivated junctions to ensure long term device reliability and parameter stability. Teccor's glass offers a rugged, reliable barrier against junction contamination.

Tape-and-reel packaging is available for the TO-92 package. Please consult factory for more information.

Variations of devices covered in this data sheet are available for custom design applications. Please consult the factory for more information.

Features

- Electrically-isolated To-220AB package
- High Voltage Capability up to 600 Volts
- High Surge Capability — up to 100 Amps
- Glass Chip Passivation

Electrical Specifications

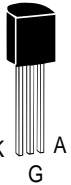
TYPE	Part Number	I_T		V_{DRM} & V_{RRM}	I_{GT}	I_{DRM} & I_{RRM}			V_{TM}	V_{GT}			I_H			
	 TO-92	Maximum On-state Current (1)		Repetitive Peak Off-state Forward & Reverse Voltage	DC Gate Trigger Current (2) (11) (17)	Peak Off-state Current at V_{DRM} & V_{RRM} (19)			Peak On-state Voltage $T_C = 25^\circ C$ (3) (10)	DC Gate Trigger Voltage (4) (11)			DC Holding Current Initial On-state Current =20mAmps (5) (14) (18)			
		Amps				Volts	μ Amps	μ Amps			Volts	Volts				
		RMS	AV					$T_C = 25^\circ C$		$T_C = 100^\circ C$		$T_C = 125^\circ C$		$T_C = -65^\circ C$	$T_C = 25^\circ C$	$T_C = 100^\circ C$
See "Package Dimensions" section for variations.	MAX		MIN	MAX	MAX			MAX	MAX		MIN	MAX				
0.8 Amp	EC103A	0.8	0.51	100	200	1.0	50		1.7	1.2	0.8	.25	5.0			
	EC103B	0.8	0.51	200	200	1.0	50		1.7	1.2	0.8	.25	5.0			
	EC103C	0.8	0.51	300	200	1.0	50		1.7	1.2	0.8	.25	5.0			
	EC103D	0.8	0.51	400	200	1.0	50		1.7	1.2	0.8	.25	5.0			
	EC103E	0.8	0.51	500	200	1.0	50		1.7	1.2	0.8	.25	5.0			
	EC103M	0.8	0.51	600	200	2.0	100		1.7	1.2	0.8	.25	5.0			
	EC103A1	0.8	0.51	100	12	1.0	50		1.7	1.2	0.8	0.2	5.0			
	EC103B1	0.8	0.51	200	12	1.0	50		1.7	1.2	0.8	0.2	5.0			
	EC103C1	0.8	0.51	300	12	1.0	50		1.7	1.2	0.8	0.2	5.0			
	EC103D1	0.8	0.51	400	12	1.0	50		1.7	1.2	0.8	0.2	5.0			
	EC103E1	0.8	0.51	500	12	1.0	50		1.7	1.2	0.8	0.2	5.0			
	EC103M1	0.8	0.51	600	12	2.0	100		1.7	1.2	0.8	0.2	5.0			
	EC103A2	0.8	0.51	100	50	1.0	50		1.7	1.2	0.8	.25	5.0			
	EC103B2	0.8	0.51	200	50	1.0	50		1.7	1.2	0.8	.25	5.0			
	EC103C2	0.8	0.51	300	50	1.0	50		1.7	1.2	0.8	.25	5.0			
	EC103D2	0.8	0.51	400	50	1.0	50		1.7	1.2	0.8	.25	5.0			
	EC103E2	0.8	0.51	500	50	1.0	50		1.7	1.2	0.8	.25	5.0			
	EC103M2	0.8	0.51	600	50	2.0	100		1.7	1.2	0.8	.25	5.0			
	EC103A3	0.8	0.51	100	500	1.0	50		1.7	1.2	0.8	.25	8.0			
	EC103B3	0.8	0.51	200	500	1.0	50		1.7	1.2	0.8	.25	8.0			
	EC103C3	0.8	0.51	300	500	1.0	50		1.7	1.2	0.8	.25	8.0			
	EC103D3	0.8	0.51	400	500	1.0	50		1.7	1.2	0.8	.25	8.0			
	EC103E3	0.8	0.51	500	500	1.0	50		1.7	1.2	0.8	.25	8.0			
	EC103M3	0.8	0.51	600	500	2.0	100		1.7	1.2	0.8	.25	8.0			
	EC113A	0.8	0.51	100	200	2.0	100		1.7	1.2	0.8	.25	15.0			
	EC113B	0.8	0.51	200	200	2.0	100		1.7	1.2	0.8	.25	15.0			
	EC113C	0.8	0.51	300	200	2.0	100		1.7	1.2	0.8	.25	15.0			
	EC113D	0.8	0.51	400	200	2.0	100		1.7	1.2	0.8	.25	15.0			
	EC113E	0.8	0.51	500	200	2.0	100		1.7	1.2	0.8	.25	15.0			
	EC113M	0.8	0.51	600	200	2.0	100		1.7	1.2	0.8	.25	15.0			
	EC113A3	0.8	0.51	100	500	2.0	100		1.7	1.2	0.8	.25	15.0			
	EC113B3	0.8	0.51	200	500	2.0	100		1.7	1.2	0.8	.25	15.0			
EC113C3	0.8	0.51	300	500	2.0	100		1.7	1.2	0.8	.25	15.0				
EC113D3	0.8	0.51	400	500	2.0	100		1.7	1.2	0.8	.25	15.0				
EC113E3	0.8	0.51	500	500	2.0	100		1.7	1.2	0.8	.25	15.0				
EC113M3	0.8	0.51	600	500	2.0	100		1.7	1.2	0.8	.25	15.0				
2N5060	0.8	0.51	30	200	1.0		50	1.7	1.2	0.8	.25	5.0				
2N5061	0.8	0.51	60	200	1.0		50	1.7	1.2	0.8	.25	5.0				
2N5062	0.8	0.51	100	200	1.0		50	1.7	1.2	0.8	.25	5.0				
2N5063	0.8	0.51	150	200	1.0		50	1.7	1.2	0.8	.25	5.0				
2N5064	0.8	0.51	200	200	1.0		50	1.7	1.2	0.8	.25	5.0				
2N6564	0.8	0.51	300	200	1.0		100	1.7	1.2	0.8	.25	5.0				
2N6565	0.8	0.51	400	200	1.0		100	1.7	1.2	0.8	.25	5.0				
1.5 AMPS	TCR22-2	1.5	.95	50	200	1.0	50	100	1.5	1.0	0.8	.25	5.0			
	TCR22-3	1.5	.95	100	200	1.0	50	100	1.5	1.0	0.8	.25	5.0			
	TCR22-4	1.5	.95	200	200	1.0	50	100	1.5	1.0	0.8	.25	5.0			
	TCR22-6	1.5	.95	400	200	1.0	50	100	1.5	1.0	0.8	.25	5.0			
TCR22-8	1.5	.95	600	200	2.0	100	200	1.5	1.0	0.8	.25	5.0				

See General Notes and Electrical Specifications Notes on page 5-4.

Sensitive SCRs

I_{GM}	V_{GRM}	P_{GM}	$P_{G(AV)}$	I_{TSM}		dv/dt	di/dt	t_{gt}	t_q	I^2t
				Amps						
Peak Gate Current (16)	Peak Reverse Gate Voltage	Peak Gate Power Dissipation (16)	Average Gate Power Dissipation	Peak One Cycle Surge Forward Current (6) (7) (12)		Critical Rate-Of-Rise Of Forward Off-State Voltage	Maximum Rate-Of-Change Of On-State Current $I_{GT} = 50mA$ With 0.1 μs Rise Time	Gate Controlled Turn-On Time Gate Pulse = 10mA Min. Width = 15 μs With Rise Time $\leq 0.1 \mu s$ (8)	Circuit Commutated Turn-Off Time (9)	RMS Surge (Non-Repetitive) On-State Current For A Period Of 8.3ms For Fusing
Amps	Volts	Watts	Watts	60Hz	50Hz	Volts/ μ Sec	Amps/ μ Sec	μ Sec	μ Sec	Amps ² /Sec
	MIN					MIN		TYP	MAX	
1.0	5.0	1.0	0.1	20	16	30	50	3.5	50	1.6
1.0	5.0	1.0	0.1	20	16	30	50	3.5	50	1.6
1.0	5.0	1.0	0.1	20	16	30	50	3.5	50	1.6
1.0	5.0	1.0	0.1	20	16	30	50	3.5	50	1.6
1.0	5.0	1.0	0.1	20	16	20	50	3.5	50	1.6
1.0	5.0	1.0	0.1	20	16	15	50	3.5	50	1.6
1.0	5.0	1.0	0.1	20	16	20	50	2.0	60	1.6
1.0	5.0	1.0	0.1	20	16	20	50	2.0	60	1.6
1.0	5.0	1.0	0.1	20	16	20	50	2.0	60	1.6
1.0	5.0	1.0	0.1	20	16	20	50	2.0	60	1.6
1.0	5.0	1.0	0.1	20	16	15	50	2.0	60	1.6
1.0	5.0	1.0	0.1	20	16	10	50	2.0	60	1.6
1.0	5.0	1.0	0.1	20	16	25	50	3.0	60	1.6
1.0	5.0	1.0	0.1	20	16	25	50	3.0	60	1.6
1.0	5.0	1.0	0.1	20	16	25	50	3.0	60	1.6
1.0	5.0	1.0	0.1	20	16	25	50	3.0	60	1.6
1.0	5.0	1.0	0.1	20	16	20	50	3.0	60	1.6
1.0	5.0	1.0	0.1	20	16	10	50	3.0	60	1.6
1.0	5.0	1.0	0.1	20	16	40	50	5.0	45	1.6
1.0	5.0	1.0	0.1	20	16	40	50	5.0	45	1.6
1.0	5.0	1.0	0.1	20	16	40	50	5.0	45	1.6
1.0	5.0	1.0	0.1	20	16	40	50	5.0	45	1.6
1.0	5.0	1.0	0.1	20	16	30	50	5.0	45	1.6
1.0	5.0	1.0	0.1	20	16	20	50	5.0	45	1.6
1.0	5.0	1.0	0.1	20	16	30	50	4.0	30	1.6
1.0	5.0	1.0	0.1	20	16	30	50	4.0	30	1.6
1.0	5.0	1.0	0.1	20	16	30	50	4.0	30	1.6
1.0	5.0	1.0	0.1	20	16	30	50	4.0	30	1.6
1.0	5.0	1.0	0.1	20	16	20	50	4.0	30	1.6
1.0	5.0	1.0	0.1	20	16	15	50	4.0	30	1.6
1.0	5.0	1.0	0.1	20	16	40	50	5.0	18	1.6
1.0	5.0	1.0	0.1	20	16	40	50	5.0	18	1.6
1.0	5.0	1.0	0.1	20	16	40	50	5.0	18	1.6
1.0	5.0	1.0	0.1	20	16	40	50	5.0	18	1.6
1.0	5.0	1.0	0.1	20	16	40	50	5.0	18	1.6
1.0	5.0	1.0	0.1	20	16	30	50	5.0	18	1.6
1.0	5.0	1.0	0.1	20	16	20	50	5.0	18	1.6
1.0	5.0	1.0	0.1	20	16	25	50	2.2	60	1.6
1.0	5.0	1.0	0.1	20	16	25	50	2.2	60	1.6
1.0	5.0	1.0	0.1	20	16	25	50	2.2	60	1.6
1.0	5.0	1.0	0.1	20	16	25	50	2.2	60	1.6
1.0	5.0	1.0	0.1	20	16	25	50	2.2	60	1.6
1.0	6.0	1.0	0.1	20	16	25	50	2.2	60	1.6
1.0	6.0	1.0	0.1	20	16	25	50	2.2	60	1.6
1.0	6.0	1.0	0.1	20	16	75	50	3.5	50	1.6
1.0	6.0	1.0	0.1	20	16	75	50	3.5	50	1.6
1.0	6.0	1.0	0.1	20	16	60	50	3.5	50	1.6
1.0	6.0	1.0	0.1	20	16	40	50	3.5	50	1.6
1.0	6.0	1.0	0.1	20	16	30	50	3.5	50	1.6

See General Notes and Electrical Specifications Notes on page 5-4.

Electrical Specifications

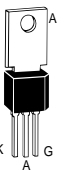
TYPE	Part Number	I_T		V_{DRM} & V_{RRM}	I_{GT}	I_{DRM} & I_{RRM}		V_{TM}	V_{GT}			I_H	I_{GM}
	Non-Isolated												
	 TO-202AB	Maximum On-State Current (1)		Repetitive Peak Off-State Forward & Reverse Voltage	DC Gate Trigger Current (2) (11) (13)	Peak Off-State Current at V_{DRM} & V_{RRM} (19)		Peak On-State Voltage $T_C = 25^\circ\text{C}$ (3) (10)	DC Gate Trigger Voltage (4) (11)			DC Holding Current Initial On-State Current = 20mA (5) (15) (18)	Peak Gate Current (16)
See "Package Dimensions" section for variations.	$I_{T(RMS)}$	$I_{T(AV)}$	Volts	μAmps	$T_C = 25^\circ\text{C}$	$T_C = 110^\circ\text{C}$	Volts	$T_C = -40^\circ\text{C}$	$T_C = 25^\circ\text{C}$	$T_C = 110^\circ\text{C}$	$T_C = 25^\circ\text{C}$	Amps	
	MAX	MAX	MIN	MAX	MAX	MAX	MAX	MAX	MAX	MIN	MAX		
4.0 Amps	T106F1	4.0	2.5	50	200	2.0	100	2.2	1.0	0.8	0.2	5.0	1.0
	T106A1	4.0	2.5	100	200	2.0	100	2.2	1.0	0.8	0.2	5.0	1.0
	T106B1	4.0	2.5	200	200	2.0	100	2.2	1.0	0.8	0.2	5.0	1.0
	T106C1	4.0	2.5	300	200	2.0	100	2.2	1.0	0.8	0.2	5.0	1.0
	T106D1	4.0	2.5	400	200	2.0	100	2.2	1.0	0.8	0.2	5.0	1.0
	T106E1	4.0	2.5	500	200	2.0	100	2.2	1.0	0.8	0.2	5.0	1.0
	T106M1	4.0	2.5	600	200	2.0	100	2.2	1.0	0.8	0.2	5.0	1.0
	T107F1	4.0	2.5	50	500	2.0	100	2.5	1.0	0.8	0.2	6.0	1.0
	T107A1	4.0	2.5	100	500	2.0	100	2.5	1.0	0.8	0.2	6.0	1.0
	T107B1	4.0	2.5	200	500	2.0	100	2.5	1.0	0.8	0.2	6.0	1.0
	T107C1	4.0	2.5	300	500	2.0	100	2.5	1.0	0.8	0.2	6.0	1.0
	T107D1	4.0	2.5	400	500	2.0	100	2.5	1.0	0.8	0.2	6.0	1.0
	T107E1	4.0	2.5	500	500	2.0	100	2.5	1.0	0.8	0.2	6.0	1.0
	T107M1	4.0	2.5	600	500	2.0	100	2.5	1.0	0.8	0.2	6.0	1.0

General Notes

- Teccor 2N5060 and 2N6564 Series devices conform to all JEDEC registered data. See specifications table on page 5-2.
- The case temperature (T_C) is measured as shown on dimensional outline drawings. See "Package Dimensions" section of this catalog.
- All measurements (except I_{GT}) are made with an external resistor $R_{GK} = 1\text{k}\Omega$ unless otherwise noted.
- All measurements are made at 60Hz with a resistive load at an ambient temperature of $+25^\circ\text{C}$ unless otherwise specified.
- Operating temperature (T_J) is -65°C to $+110^\circ\text{C}$ for "EC" Series devices; -65°C to $+125^\circ\text{C}$ for "2N" Series devices; -40°C to $+125^\circ\text{C}$ for "TCR" Series; and -40°C to $+110^\circ\text{C}$ for all others.
- Storage temperature range (T_S) is -65°C to $+150^\circ\text{C}$ for TO-92 devices; -40°C to $+150^\circ\text{C}$ for TO-202 devices; and -40°C to $+125^\circ\text{C}$ for all others.
- Lead solder temperature is a maximum of $+230^\circ\text{C}$ for 10 seconds maximum $\geq 1/16"$ (1.59mm) from case.

Electrical Specification Notes

- (1) See Figures 5.1 through 5.9 for current ratings at specified operating case temperatures.
- (2) See Figure 5.10 for I_{GT} vs T_C .
- (3) See Figure 5.11 for instantaneous on-state current (I_T) vs on-state voltage (V_T) - (typical).
- (4) See Figure 5.12 for V_{GT} vs T_C .
- (5) See Figure 5.13 for I_H vs T_C .
- (6) For more than one full cycle, see Figure 5.14.

- (7) 0.8 - 4.0A devices also have a pulse peak forward current on-state rating (repetitive) of 75A. This rating applies for operation at 60Hz, 75°C maximum tab (or anode) lead temperature, switching from 80V peak, sinusoidal current pulse width of $10\mu\text{s}$ minimum, $15\mu\text{s}$ maximum. See Figures 5.20 and 5.21.
- (8) See Figure 5.15 for t_{gt} vs I_{GT} .
- (9) Test conditions as follows:
 $T_C \leq 80^\circ\text{C}$, rectangular current waveform; rate-of-rise of current $\leq 10\text{A}/\mu\text{s}$. Rate-of-reversal of current $\leq 5\text{A}/\mu\text{s}$. $I_{TM} = 1\text{A}$ ($50\mu\text{s}$ pulse) Repetition Rate = 60pps. $V_{RRM} = \text{Rated}$. $V_R = 15\text{V}$ minimum, $V_{DRM} = \text{Rated}$. Rate-of-rise reapplied forward blocking voltage = $5\text{V}/\mu\text{s}$. Gate Bias = 0V, 100Ω (during turn-off time interval).
- (10) Test condition is maximum rated RMS current except TO-92 devices are 1.2A_{PK} ; T106/T107 devices are 4A_{PK} .
- (11) $V_D = 6\text{VDC}$, $R_L = 100\Omega$. See Figure 5.19 for simple test circuit for measuring gate trigger voltage and gate trigger current.
- (12) See Figures 5.1 through 5.9 for maximum allowable case temperature at maximum rated current.
- (13) $I_{GT} = 500\mu\text{A}$ maximum for $T_C = -40^\circ\text{C}$ for T106 devices.
- (14) $I_H = 10\text{mA}$ maximum for $T_C = -65^\circ\text{C}$ for 2N5060 Series and 2N6564 Series devices.
- (15) $I_H = 6\text{mA}$ maximum for $T_C = -40^\circ\text{C}$ for T106 devices.
- (16) Pulse Width $\leq 10\mu\text{s}$.
- (17) $I_{GT} = 350\mu\text{A}$ maximum at $T_C = -65^\circ\text{C}$ for 2N5060 Series and 2N6564 Series devices.
- (18) Latching current can be higher than 20mA for higher I_{GT} types. Also latching current can be much higher at -40°C . See Figure 5.18.
- (19) $T_C = T_J$ for test conditions in off-state.

V_{GRM}	P_{GM}	$P_{G(AV)}$	I_{TSM}		dv/dt	di/dt	t_{gt}	t_q	I^2t
Peak Reverse Gate Voltage	Peak Gate Power Dissipation (16)	Average Gate Power Dissipation	Peak One Cycle Surge Forward Current (6) (7) (12)		Critical Rate-Of-Rise Of Forward Off-State Voltage	Maximum Rate-Of-Change Of On-State Current $I_{GT} = 50mA$ with $0.1\mu s$ Rise Time	Gate Controlled Turn-On Time Gate Pulse = $10mA$ Min. Width = $15\mu s$ with Rise Time $\leq 0.1\mu s$ (8)	Circuit Commutated Turn-Off Time (9)	RMS Surge (Non-Repetitive) On-State Current For A Period Of 8.3 msec for Fusing
Volts	Watts	Watts	Amps		Volts/ μSec	Amps/ μSec	μSec	μSec	Amps ² Sec
MIN			60Hz	50Hz	$T_C = 110^\circ C$				
					TYP		TYP	MAX	
6.0	1.0	0.1	20	16	8	50	4.0	50	1.6
6.0	1.0	0.1	20	16	8	50	4.0	50	1.6
6.0	1.0	0.1	20	16	8	50	4.0	50	1.6
6.0	1.0	0.1	20	16	8	50	4.0	50	1.6
6.0	1.0	0.1	20	16	8	50	4.0	50	1.6
6.0	1.0	0.1	20	16	8	50	4.0	50	1.6
6.0	1.0	0.1	20	16	8	50	4.0	50	1.6
6.0	1.0	0.1	20	16	8	50	4.0	50	1.6
6.0	1.0	0.1	20	16	8	50	5.0	45	1.6
6.0	1.0	0.1	20	16	8	50	5.0	45	1.6
6.0	1.0	0.1	20	16	8	50	5.0	45	1.6
6.0	1.0	0.1	20	16	8	50	5.0	45	1.6
6.0	1.0	0.1	20	16	8	50	5.0	45	1.6
6.0	1.0	0.1	20	16	8	50	5.0	45	1.6
6.0	1.0	0.1	20	16	8	50	5.0	45	1.6
6.0	1.0	0.1	20	16	8	50	5.0	45	1.6
6.0	1.0	0.1	20	16	8	50	5.0	45	1.6

Electrical Specifications

TYPE	Part Number		I_T		V_{DRM} & V_{RRM}	I_{GT}	I_{DRM} & I_{RRM}		V_{TM}	V_{GT}			I_H
	Isolated	Non-Isolated											
	See "Package Dimensions" section for variations.		$I_{T(RMS)}$ MAX	$I_{T(AV)}$ MAX	Volts MIN	μ Amps MAX	$T_C = 25^\circ\text{C}$ MAX	$T_C = 110^\circ\text{C}$ MAX	Volts MAX	$T_C = -40^\circ\text{C}$ MAX	$T_C = 25^\circ\text{C}$ MAX	$T_C = 110^\circ\text{C}$ MIN	mAmps MAX
6.0 Amps	S0506LS2	S0506FS21	6.0	3.8	50	200	.005	0.25	1.6	1.0	0.8	.25	6.0
	S0506LS3	S0506FS31	6.0	3.8	50	500	.005	0.25	1.6	1.0	0.8	.25	8.0
	S1006LS2	S1006FS21	6.0	3.8	100	200	.005	0.25	1.6	1.0	0.8	.25	6.0
	S1006LS3	S1006FS31	6.0	3.8	100	500	.005	0.25	1.6	1.0	0.8	.25	8.0
	S2006LS2	S2006FS21	6.0	3.8	200	200	.005	0.25	1.6	1.0	0.8	.25	6.0
	S2006LS3	S2006FS31	6.0	3.8	200	500	.005	0.25	1.6	1.0	0.8	.25	8.0
	S4006LS2	S4006FS21	6.0	3.8	400	200	.005	0.25	1.6	1.0	0.8	.25	6.0
	S4006LS3	S4006FS31	6.0	3.8	400	500	.005	0.25	1.6	1.0	0.8	.25	8.0
8.0 Amps	S6006LS2	S6006FS21	6.0	3.8	600	200	.005	0.25	1.6	1.0	0.8	.25	6.0
	S6006LS3	S6006FS31	6.0	3.8	600	500	.005	0.25	1.6	1.0	0.8	.25	8.0
	S0508LS2	S0508FS21	8.0	5.1	50	200	.005	0.25	1.6	1.0	0.8	.25	6.0
	S0508LS3	S0508FS31	8.0	5.1	50	500	.005	0.25	1.6	1.0	0.8	.25	8.0
	S1008LS2	S1008FS21	8.0	5.1	100	200	.005	0.25	1.6	1.0	0.8	.25	6.0
	S1008LS3	S1008FS31	8.0	5.1	100	500	.005	0.25	1.6	1.0	0.8	.25	8.0
	S2008LS2	S2008FS21	8.0	5.1	200	200	.005	0.25	1.6	1.0	0.8	.25	6.0
	S2008LS3	S2008FS31	8.0	5.1	200	500	.005	0.25	1.6	1.0	0.8	.25	8.0
10.0 Amps	S4008LS2	S4008FS21	8.0	5.1	400	200	.005	0.25	1.6	1.0	0.8	.25	6.0
	S4008LS3	S4008FS31	8.0	5.1	400	500	.005	0.25	1.6	1.0	0.8	.25	8.0
	S6008LS2	S6008FS21	8.0	5.1	600	200	.005	0.25	1.6	1.0	0.8	.25	6.0
	S6008LS3	S6008FS31	8.0	5.1	600	500	.005	0.25	1.6	1.0	0.8	.25	8.0
	S0510LS2	S0510FS21	10.0	6.4	50	200	.005	0.25	1.6	1.0	0.8	.25	6.0
	S0510LS3	S0510FS31	10.0	6.4	50	500	.005	0.25	1.6	1.0	0.8	.25	8.0
	S1010LS2	S1010FS21	10.0	6.4	100	200	.005	0.25	1.6	1.0	0.8	.25	6.0
	S1010LS3	S1010FS31	10.0	6.4	100	500	.005	0.25	1.6	1.0	0.8	.25	8.0
	S2010LS2	S2010FS21	10.0	6.4	200	200	.005	0.25	1.6	1.0	0.8	.25	6.0
	S2010LS3	S2010FS31	10.0	6.4	200	500	.005	0.25	1.6	1.0	0.8	.25	8.0
S4010LS2	S4010FS21	10.0	6.4	400	200	.005	0.25	1.6	1.0	0.8	.25	6.0	
S4010LS3	S4010FS31	10.0	6.4	400	500	.005	0.25	1.6	1.0	0.8	.25	8.0	
S6010LS2	S6010FS21	10.0	6.4	600	200	.005	0.25	1.6	1.0	0.8	.25	6.0	
S6010LS3	S6010FS31	10.0	6.4	600	500	.005	0.25	1.6	1.0	0.8	.25	8.0	

General Notes



- Teccor 2N5060 and 2N6564 Series devices conform to all JEDEC registered data. See specifications table on page 5-2.
- The case temperature (T_C) is measured as shown on dimensional outline drawings. See "Package Dimensions" section of this catalog.
- All measurements (except I_{GT}) are made with an external resistor $R_{GK} = 1k\Omega$ unless otherwise noted.
- All measurements are made at 60Hz with a resistive load at an ambient temperature of $+25^\circ\text{C}$ unless otherwise specified.
- Operating temperature (T_J) is -65°C to $+110^\circ\text{C}$ for "EC" Series devices; -65°C to $+125^\circ\text{C}$ for "2N" Series devices; -40°C to $+125^\circ\text{C}$ for "TCR" Series; and -40°C to $+110^\circ\text{C}$ for all others.
- Storage temperature range (T_S) is -65°C to $+150^\circ\text{C}$ for TO-92 devices; -40°C to $+150^\circ\text{C}$ for TO-202 devices; and -40°C to $+125^\circ\text{C}$ for all others.
- Lead solder temperature is a maximum of $+230^\circ\text{C}$ for 10 seconds maximum $\geq 1/16"$ (1.59mm) from case.

I_{GM}	V_{GRM}	P_{GM}	$P_{G(AV)}$	I_{TSM}		dv/dt	di/dt	t_{gt}	t_q	I^2t
Amps	Volts	Watts	Watts	Amps		Volts/ μ Sec $T_C = 110^\circ C$	Amps/ μ Sec	μ Sec	μ Sec	Amps ² Sec
	MIN			60 Hz	50 Hz	TYP		TYP	MAX	
1.0	6.0	1.0	0.1	100	83	20	100	4.0	50	41
1.0	6.0	1.0	0.1	100	83	20	100	5.0	45	41
1.0	6.0	1.0	0.1	100	83	10	100	4.0	50	41
1.0	6.0	1.0	0.1	100	83	10	100	5.0	45	41
1.0	6.0	1.0	0.1	100	83	10	100	4.0	50	41
1.0	6.0	1.0	0.1	100	83	10	100	5.0	45	41
1.0	6.0	1.0	0.1	100	83	5	100	4.0	50	41
1.0	6.0	1.0	0.1	100	83	5	100	5.0	45	41
1.0	6.0	1.0	0.1	100	83	5	100	4.0	50	41
1.0	6.0	1.0	0.1	100	83	5	100	5.0	45	41
1.0	6.0	1.0	0.1	100	83	20	100	4.0	50	41
1.0	6.0	1.0	0.1	100	83	20	100	5.0	45	41
1.0	6.0	1.0	0.1	100	83	10	100	4.0	50	41
1.0	6.0	1.0	0.1	100	83	10	100	5.0	45	41
1.0	6.0	1.0	0.1	100	83	10	100	4.0	50	41
1.0	6.0	1.0	0.1	100	83	10	100	5.0	45	41
1.0	6.0	1.0	0.1	100	83	5	100	4.0	50	41
1.0	6.0	1.0	0.1	100	83	5	100	5.0	45	41
1.0	6.0	1.0	0.1	100	83	5	100	4.0	50	41
1.0	6.0	1.0	0.1	100	83	5	100	5.0	45	41
1.0	6.0	1.0	0.1	100	83	20	100	4.0	50	41
1.0	6.0	1.0	0.1	100	83	20	100	5.0	45	41
1.0	6.0	1.0	0.1	100	83	10	100	4.0	50	41
1.0	6.0	1.0	0.1	100	83	10	100	5.0	45	41
1.0	6.0	1.0	0.1	100	83	10	100	4.0	50	41
1.0	6.0	1.0	0.1	100	83	10	100	5.0	45	41
1.0	6.0	1.0	0.1	100	83	5	100	4.0	50	41
1.0	6.0	1.0	0.1	100	83	5	100	5.0	45	41
1.0	6.0	1.0	0.1	100	83	5	100	4.0	50	41
1.0	6.0	1.0	0.1	100	83	5	100	5.0	45	41

Electrical Specification Notes

- (1) See Figures 5.1 through 5.9 for current ratings at specified operating case temperatures.
- (2) See Figure 5.10 for I_{GT} vs T_C .
- (3) See Figure 5.11 for instantaneous on-state current (I_T) vs on-state voltage (V_T) - (typical).
- (4) See Figure 5.12 for V_{GT} vs T_C .
- (5) See Figure 5.13 for I_H vs T_C .
- (6) For more than one full cycle, see Figure 5.14.
- (7) 0.8 - 4.0A devices also have a pulse peak forward current on-state rating (repetitive) of 75A. This rating applies for operation at 60Hz, 75°C maximum tab (or anode) lead temperature, switching from 80V peak, sinusoidal current pulse width of 10 μs minimum, 15 μs maximum. See Figures 5.20 and 5.21.
- (8) See Figure 5.15 for t_{gt} vs I_{GT} .
- (9) Test conditions as follows:
 $T_C \leq 80^\circ C$, rectangular current waveform; rate-of-rise of current $\leq 10A/\mu s$. Rate-of-reversal of current $\leq 5A/\mu s$. $I_{TM} = 1A$ (50 μs pulse)
 Repetition Rate = 60pps. $V_{RRM} = \text{Rated}$.
 $V_R = 15V$ minimum, $V_{DRM} = \text{Rated}$. Rate-of-rise reapplied forward blocking voltage = 5V/ μs . Gate Bias = 0V, 100 Ω (during turn-off time interval).
- (10) Test condition is maximum rated RMS current except TO-92 devices are 1.2 A_{PK} ; T106/T107 devices are 4 A_{PK} .
- (11) $V_D = 6VDC$, $R_L = 100\Omega$. See Figure 5.19 for simple test circuit for measuring gate trigger voltage and gate trigger current.
- (12) See Figures 5.1 through 5.9 for maximum allowable case temperature at maximum rated current.
- (13) $I_{GT} = 500\mu A$ maximum for $T_C = -40^\circ C$ for T106 devices.
- (14) $I_H = 10mA$ maximum for $T_C = -65^\circ C$ for 2N5060 Series and 2N6564 Series devices.
- (15) $I_H = 6mA$ maximum for $T_C = -40^\circ C$ for T106 devices.
- (16) Pulse Width $\leq 10\mu s$.
- (17) $I_{GT} = 350\mu A$ maximum at $T_C = -65^\circ C$ for 2N5060 Series and 2N6564 Series devices.
- (18) Latching current can be higher than 20mA for higher I_{GT} types. Also latching current can be much higher at $-40^\circ C$. See Figure 5.18.
- (19) $T_C = T_J$ for test conditions in off-state.

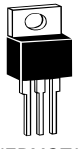
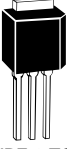
Electrical Specifications

THERMAL RESISTANCE (STEADY STATE) $R_{\theta JC}$ [$R_{\theta JA}$] °C/W (TYPICAL)				
	E	L	F2	F
				
	TO-92	THERMOTAB TO-220AB	TYPE 2 TO- 202AB	TYPE 1 & 3 TO-202AB
0.8 Amp	75 [160]			
1.5 Amps	50 [160]			
4.0 Amps			10 [100]	6.2 [80]
6.0 Amps		4.0 [65]		4.3
8.0 Amps		3.4		3.9
10.0 Amps		3.0		3.4

Electrical Isolation

Teccor's isolated sensitive SCRs will withstand a minimum high potential test of 2500 VAC RMS from leads to mounting tab over the device's operating temperature range. See table below for other standard and optional isolation ratings.

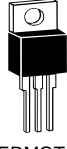
ELECTRICAL ISOLATION FROM LEADS TO MOUNTING TAB	
VAC(RMS)	
	THERMOTAB** TO-220AB
2500	Standard
4000	Optional*

*For 4000V Isolation use "V" Suffix in part number

**UL Recognized File #E71639

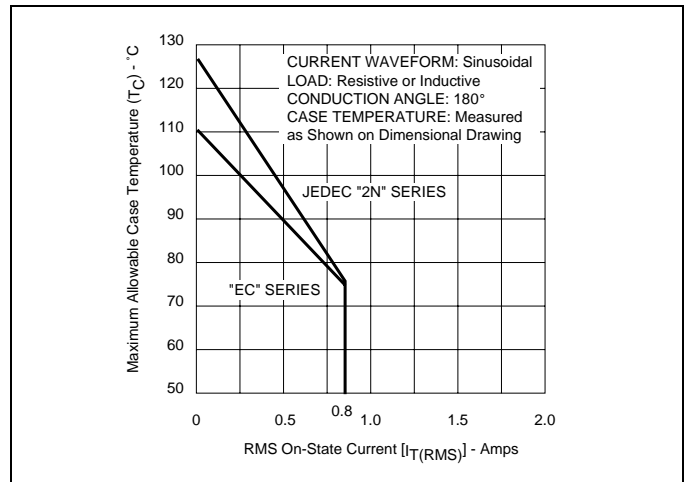

Figure 5.1 Maximum Allowable Case Temperature vs RMS On-State Current (JEDEC "2N" Series and "EC" Series)

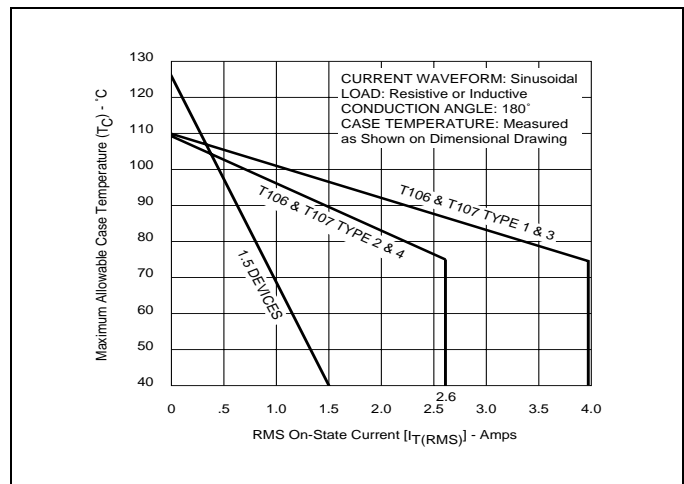

Figure 5.2 Maximum Allowable Case Temperature vs RMS On-State Current (T106 and T107)

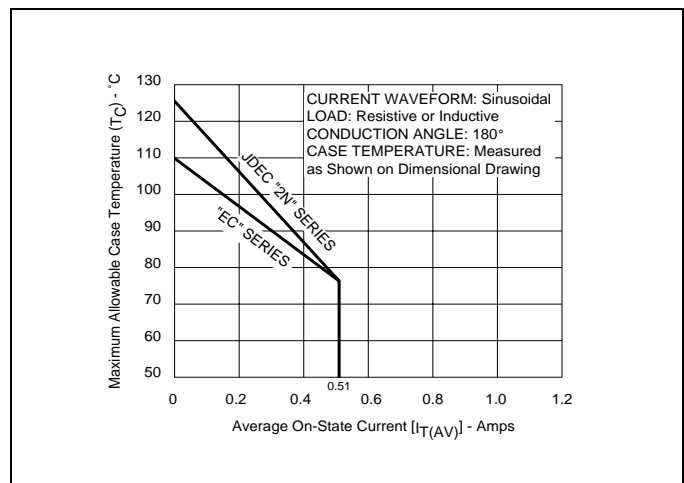

Figure 5.3 Maximum Allowable Case Temperature vs Average On-State Current (JEDEC "2N" Series and "EC" Series)

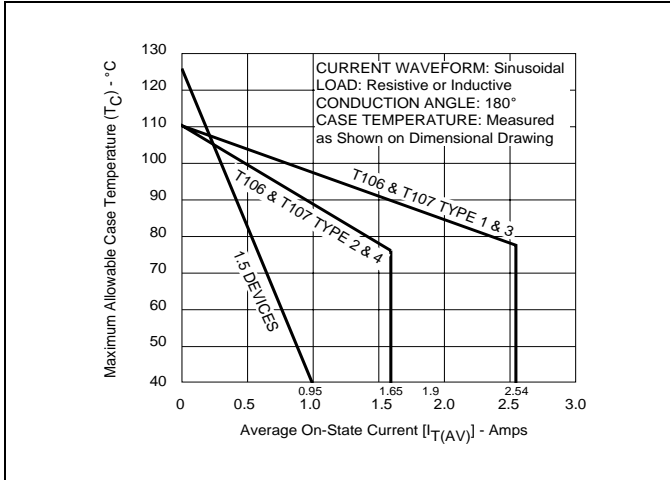

Figure 5.4 Maximum Allowable Case Temperature vs Average On-State Current (T106 and T107)

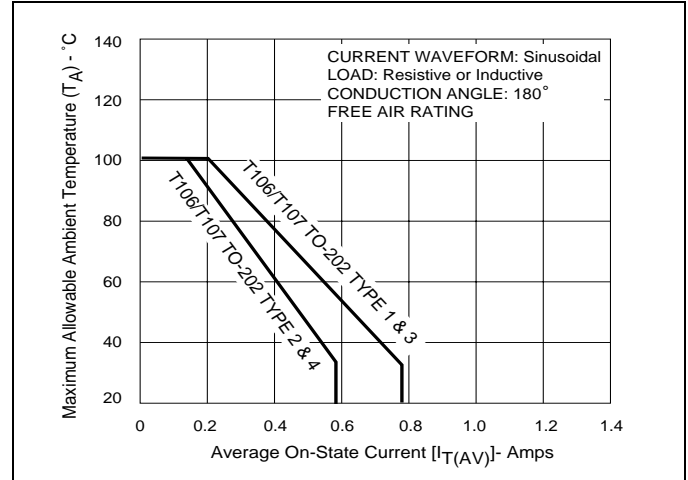

Figure 5.7 Maximum Allowable Ambient Temperature vs Average On-State Current

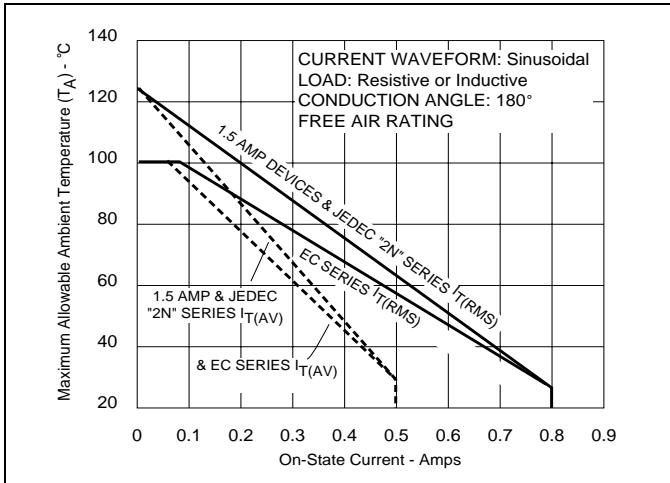

Figure 5.5 Maximum Allowable Ambient Temperature vs On-State Current (1.5 Amp, JEDEC "2N" Series and "EC" Series)

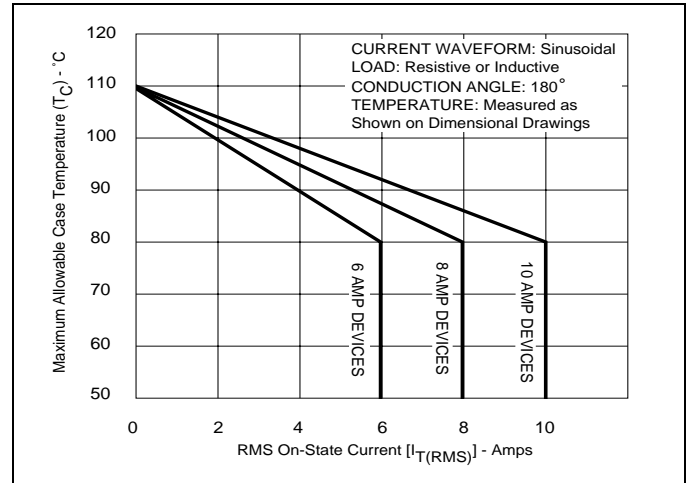

Figure 5.8 Maximum Allowable Case Temperature vs RMS On-State Current

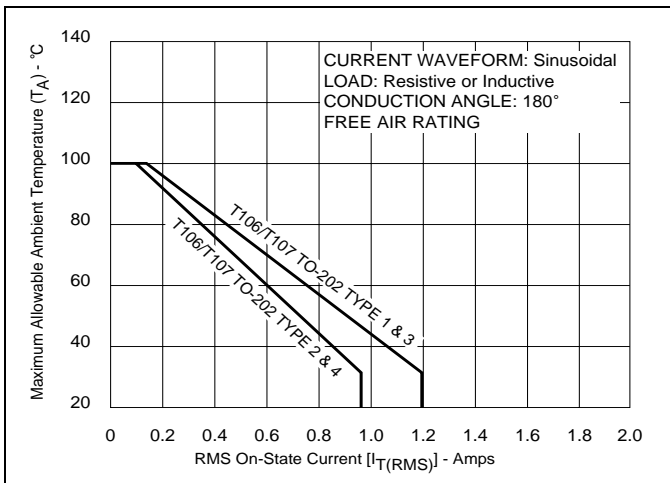

Figure 5.6 Maximum Allowable Ambient Temperature vs RMS On-State Current (T106 and T107)

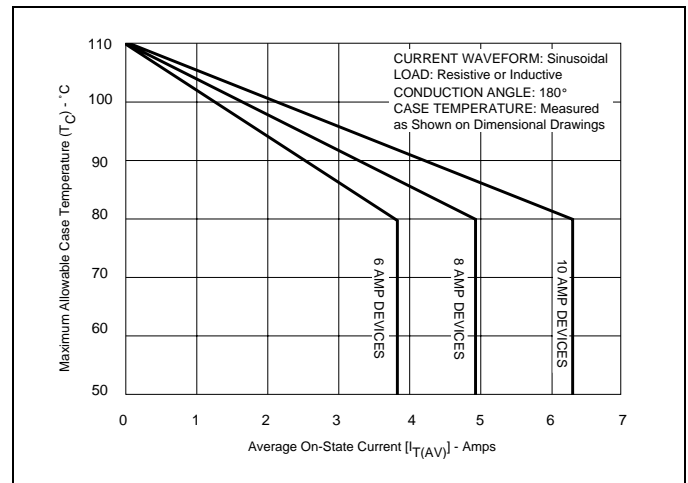

Figure 5.9 Maximum Allowable Case Temperature vs Average On-State Current

Electrical Specifications

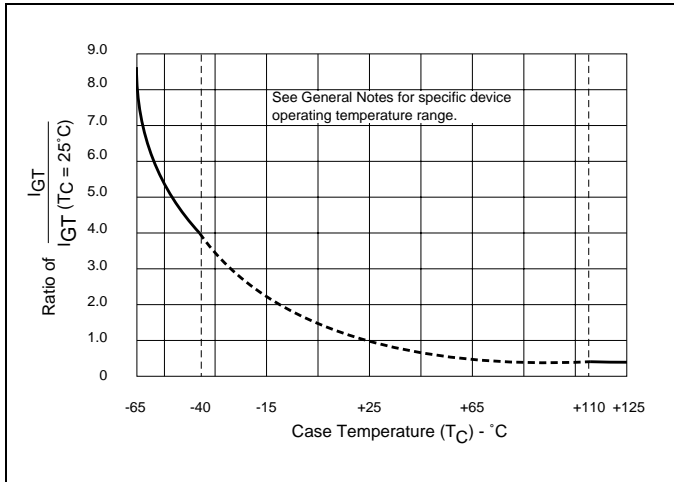

Figure 5.10 Normalized DC Gate-Trigger Current vs Case Temperature

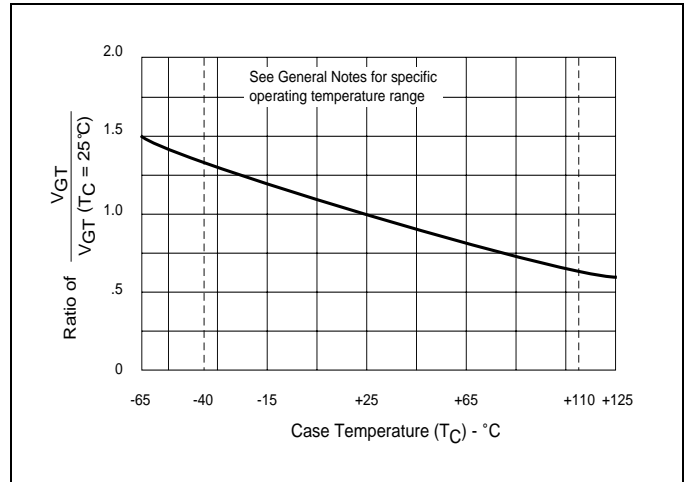

Figure 5.12 Normalized DC Gate-Trigger Voltage vs Case Temperature

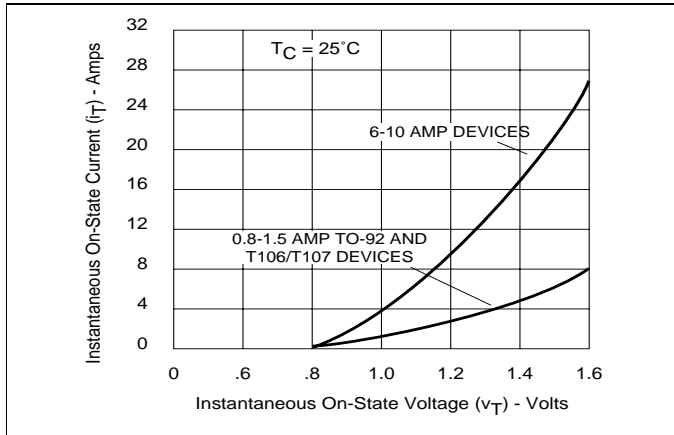

Figure 5.11 Instantaneous On-State Current vs On-State Voltage (Typical)

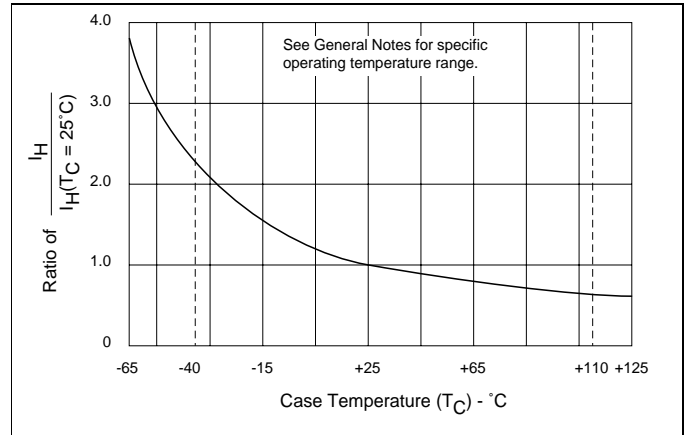

Figure 5.13 Normalized DC Holding Current vs Case Temperature

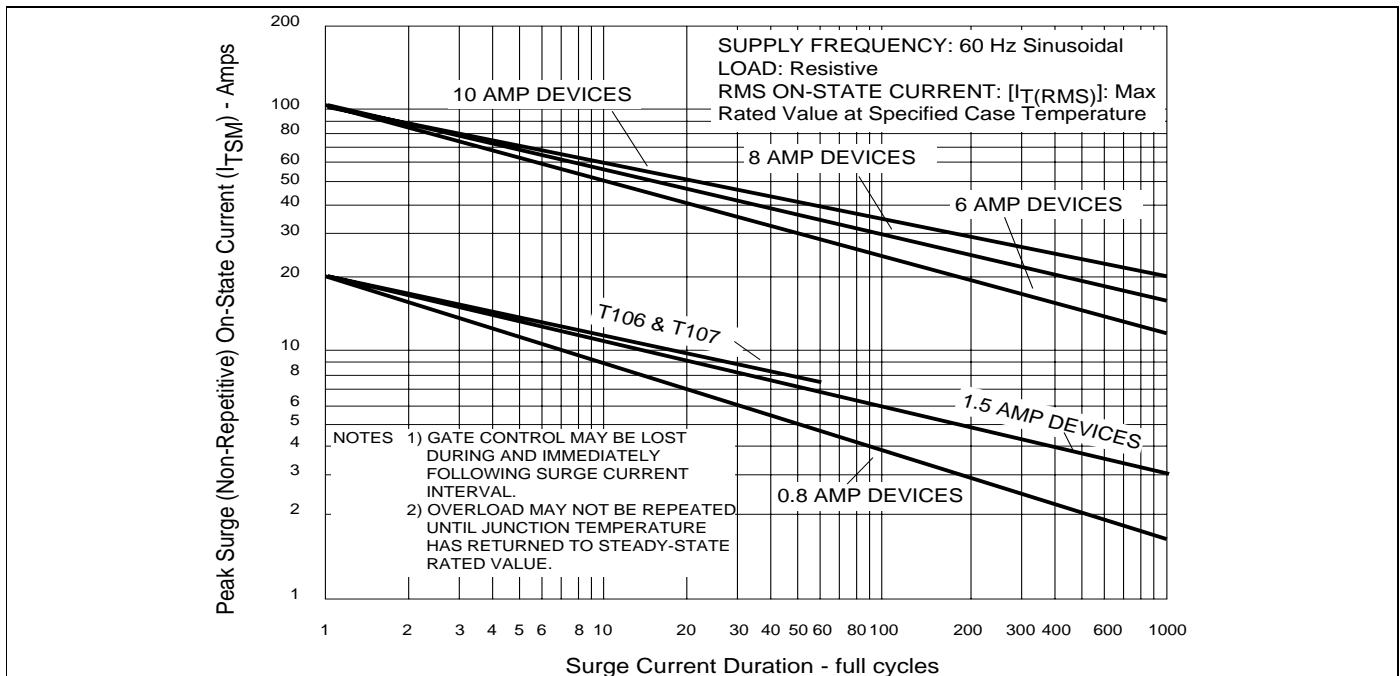

Figure 5.14 Peak Surge On-State Current vs Surge Current Duration

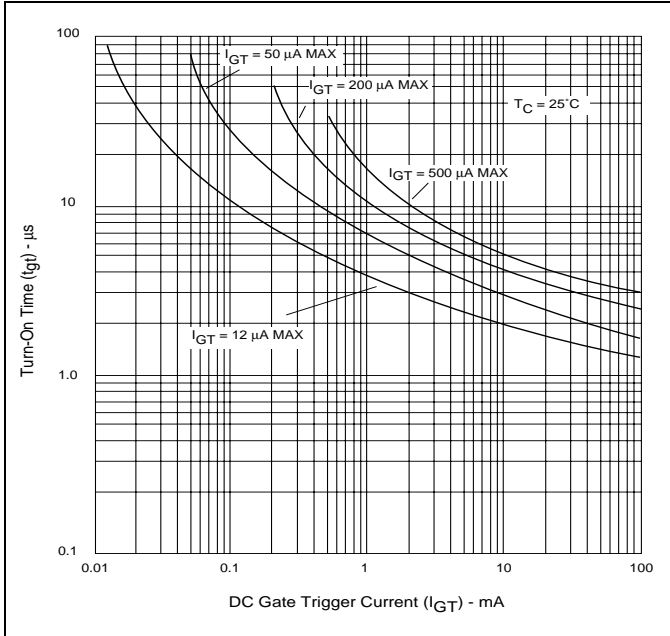

Figure 5.15 Typical Turn-On Time vs Gate Trigger Current

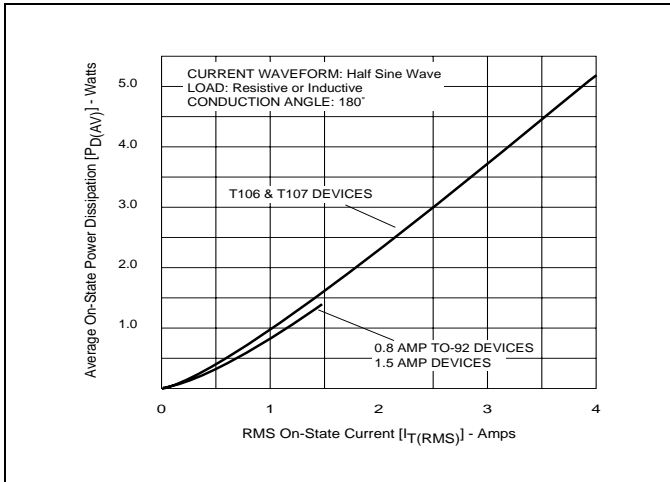

Figure 5.16 Power Dissipation (Typical) vs RMS On-State Current

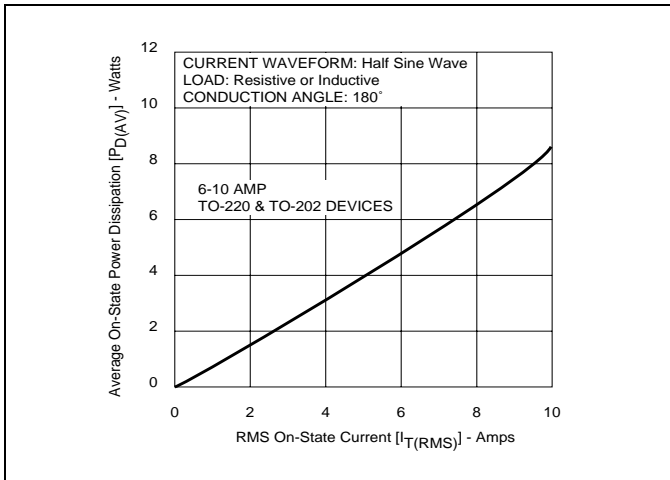

Figure 5.17 Power Dissipation (Typical) vs RMS On-State Current

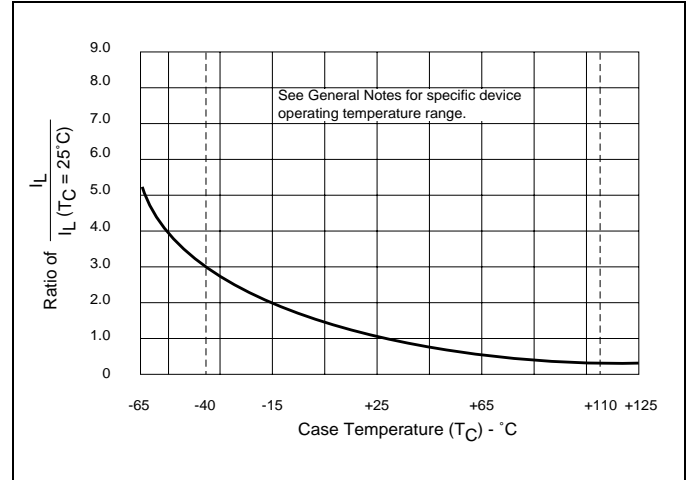

Figure 5.18 Normalized DC Latching Current vs Case Temperature

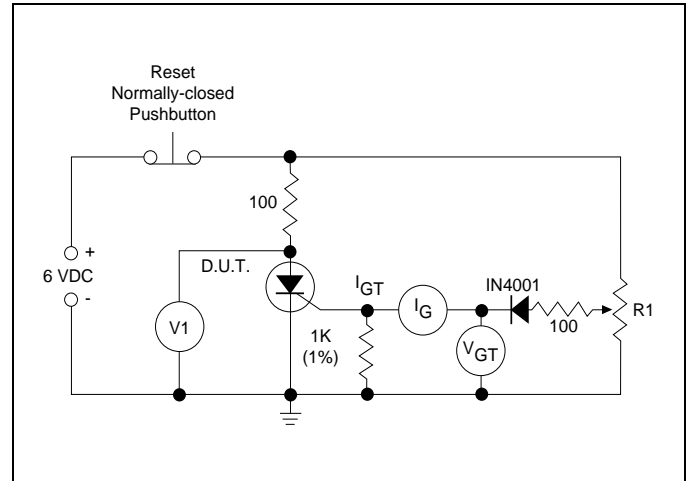

Figure 5.19 Simple Test Circuit For Gate Trigger Voltage and Current Measurement

Note: V1 — 0-10 volt DC meter
 V_{GT} — 0-1 volt DC meter
 I_G — 0-1mA DC millimeter
 R1 — 1K potentiometer

To measure gate trigger voltage and current, raise gate voltage (V_{GT}) until meter reading V1 drops from 6 volts to 1 volt. Gate trigger voltage is the reading on V_{GT} just prior to V1 dropping. Gate trigger current I_{GT} can be computed from the relationship:

$$I_{GT} = I_G - \frac{V_{GT}}{1000} \text{ Amps}$$

where I_G is reading (in amps) on meter just prior to V1 dropping.

Note: I_{GT} may turn out to be a negative quantity (trigger current flows out from gate lead).

Electrical Specifications

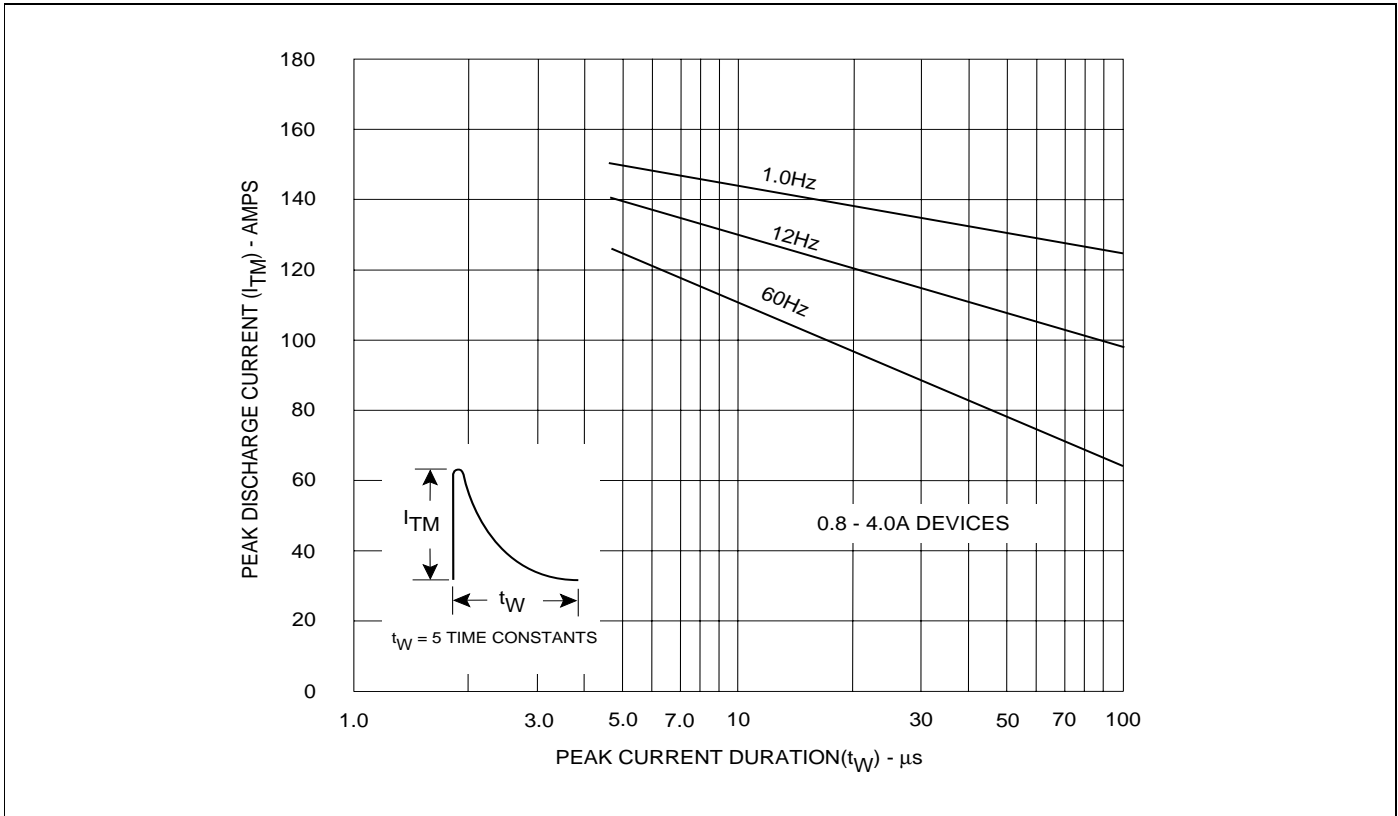

Figure 5.20 Peak Repetitive Capacitor Discharge Current

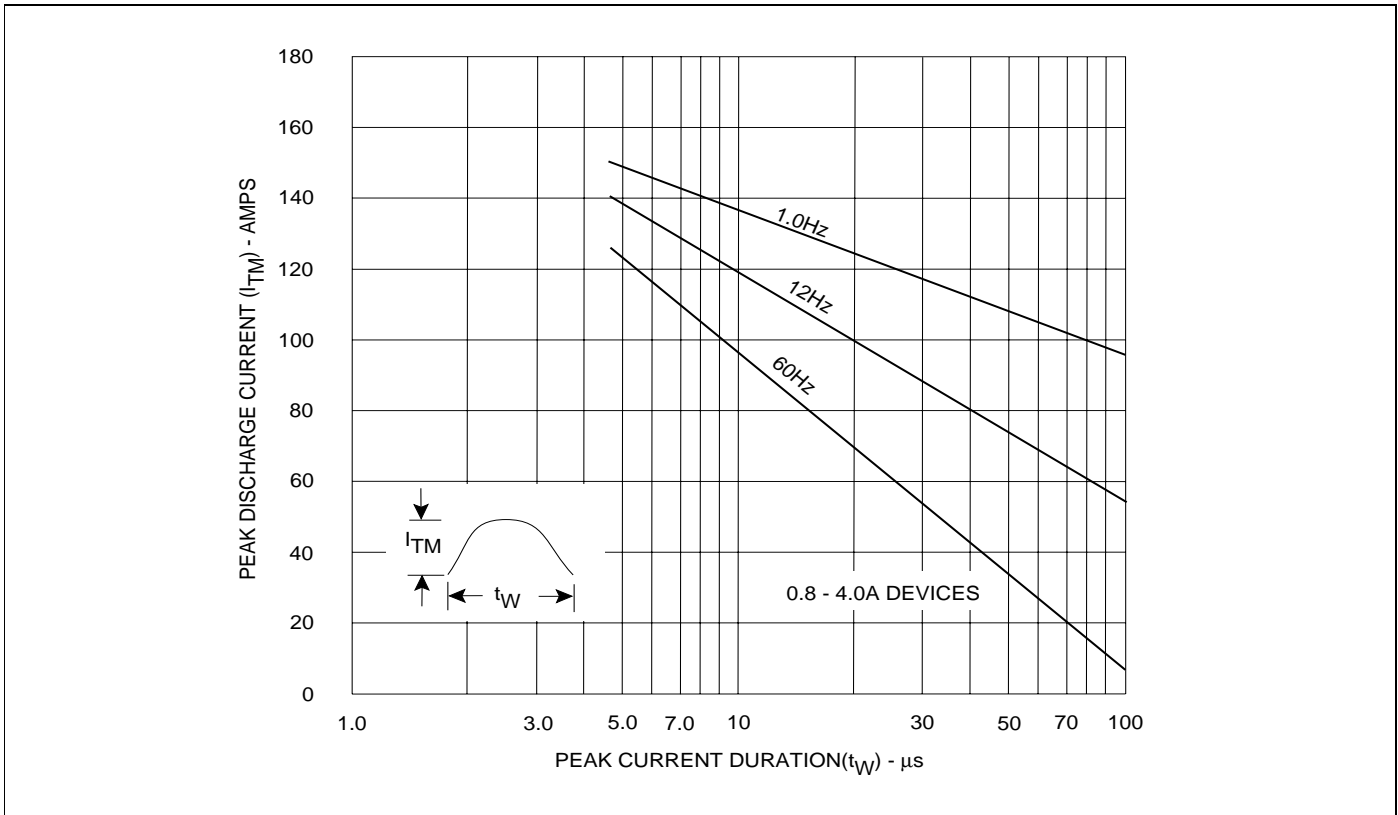

Figure 5.21 Peak Repetitive Sinusoidal Curve