

**50V P-CHANNEL Enhancement Mode MOSFET**

# MTP3J15N3

$BV_{DSS}$	-50V
$I_D$	-130mA
$R_{DS(on)}@V_{GS}=-10V, I_D=-100mA$	4.5 $\Omega$ (typ)
$R_{DS(on)}@V_{GS}=-5V, I_D=-100mA$	6 $\Omega$ (typ)

**Features**

- Low gate charge
- Excellent thermal and electrical capabilities
- Pb-free package

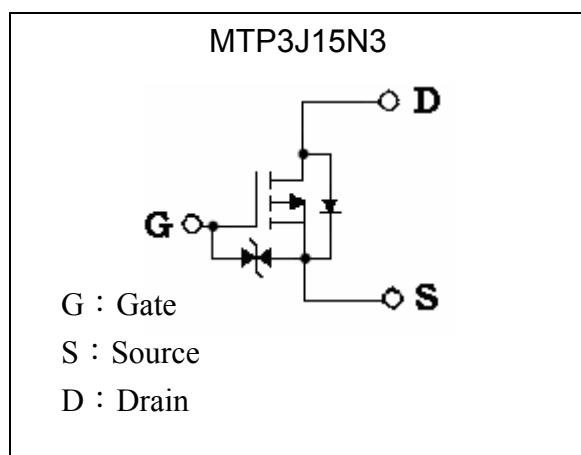
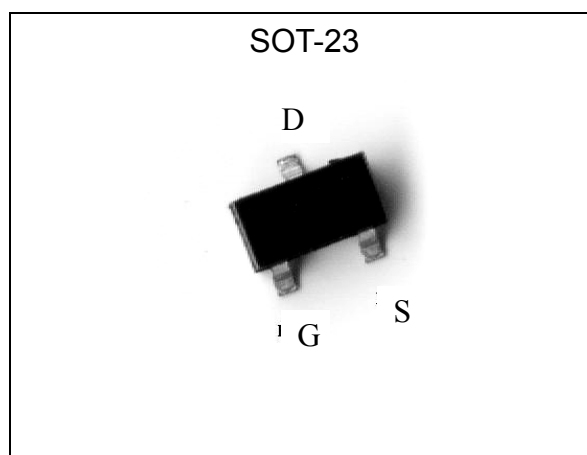
**Equivalent Circuit**

**Outline**

**Absolute Maximum Ratings** ( $T_j=25^\circ\text{C}$ , unless otherwise noted)

Parameter	Symbol	Limits	Unit
Drain-Source Voltage	$V_{DS}$	-50	V
Gate-Source Voltage	$V_{GS}$	$\pm 20$	V
Continuous Drain Current @ $T_A=25^\circ\text{C}$ , $V_{GS}=-5V$	$I_D$	-130	mA
Pulsed Drain Current (Note 1)	$I_{DM}$	-520	mA
Maximum Power Dissipation @ $T_A=25^\circ\text{C}$	$P_D$	225	mW
Thermal Resistance, Junction-to-Ambient	$R_{th,ja}$	556	$^\circ\text{C}/\text{W}$
Maximum Lead Temperature for Soldering Purpose, 10 s	$T_L$	260	$^\circ\text{C}$
Operating Junction and Storage Temperature	$T_j, T_{stg}$	-55~+150	$^\circ\text{C}$

 Note : 1. Pulse width  $\leq 10\mu\text{s}$ , duty cycle  $\leq 2\%$ .



**Electrical Characteristics** (Tj=25°C, unless otherwise specified)

Symbol	Min.	Typ.	Max.	Unit	Test Conditions
<b>Static</b>					
BV <sub>DSS</sub>	-50	-	-	V	V <sub>GS</sub> =0V, I <sub>D</sub> =-250μA
V <sub>GS(th)</sub>	-1	-1.4	-2	V	V <sub>DS</sub> =V <sub>GS</sub> , I <sub>D</sub> =-1mA
G <sub>FS</sub>	100	-	-	mS	V <sub>DS</sub> =-15V, I <sub>D</sub> =-100mA
I <sub>GSS</sub>	-	-	±10	μA	V <sub>GS</sub> =±20V, V <sub>DS</sub> =0
I <sub>DSS</sub>	-	-	-0.1	μA	V <sub>DS</sub> =-25V, V <sub>GS</sub> =0
	-	-	-1		V <sub>DS</sub> =-50V, V <sub>GS</sub> =0
	-	-	-25		V <sub>DS</sub> =-50V, V <sub>GS</sub> =0, Tj=125°C
*R <sub>DS(ON)</sub>	-	6	10	Ω	V <sub>GS</sub> =-5V, I <sub>D</sub> =-100mA
	-	5	8		V <sub>GS</sub> =-10V, I <sub>D</sub> =-100mA
<b>Dynamic</b>					
C <sub>iSS</sub>	-	25	-	pF	V <sub>DS</sub> =-5V, V <sub>GS</sub> =0, f=1MHz
C <sub>oSS</sub>	-	7	-		
C <sub>rSS</sub>	-	2	-		
*t <sub>d(ON)</sub>	-	2.5	-	ns	V <sub>DS</sub> =-15V, I <sub>D</sub> =-100mA, V <sub>GS</sub> =-5V, R <sub>G</sub> =3.3Ω
*t <sub>r</sub>	-	2	-		
*t <sub>d(OFF)</sub>	-	7.3	-		
*t <sub>f</sub>	-	3	-		
*Q <sub>g</sub>	-	1.2	-	nC	V <sub>DS</sub> =-40V, I <sub>D</sub> =-500mA, V <sub>GS</sub> =-5V
<b>Source-Drain Diode</b>					
*I <sub>S</sub>	-	-	-130	mA	
*I <sub>SM</sub>	-	-	-520		
*V <sub>SD</sub>	-	-0.85	-1.2	V	V <sub>GS</sub> =0V, I <sub>S</sub> =-130mA

\*Pulse Test : Pulse Width ≤300μs, Duty Cycle≤2%

**Ordering Information**

Device	Package	Shipping	Marking
MTP3J15N3	SOT-23 (Pb-free)	3000 pcs / Tape & Reel	PD

**Typical Characteristics**

Typical Output Characteristics

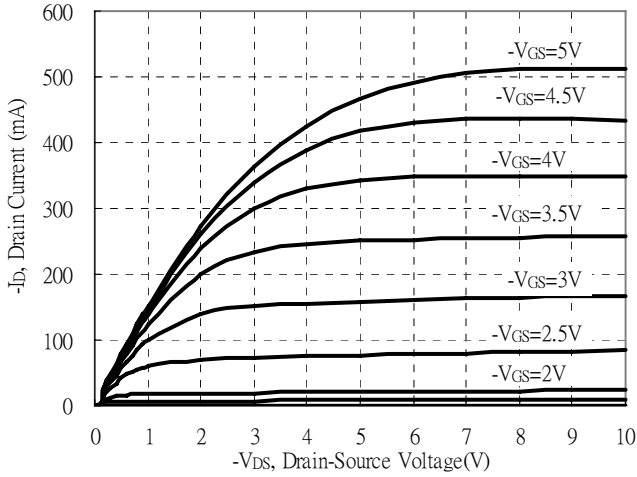

Breakdown Voltage vs Ambient Temperature

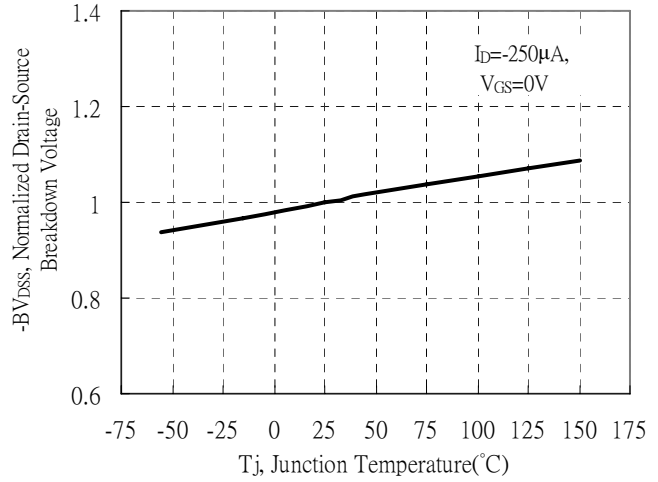

Static Drain-Source On-State resistance vs Drain Current

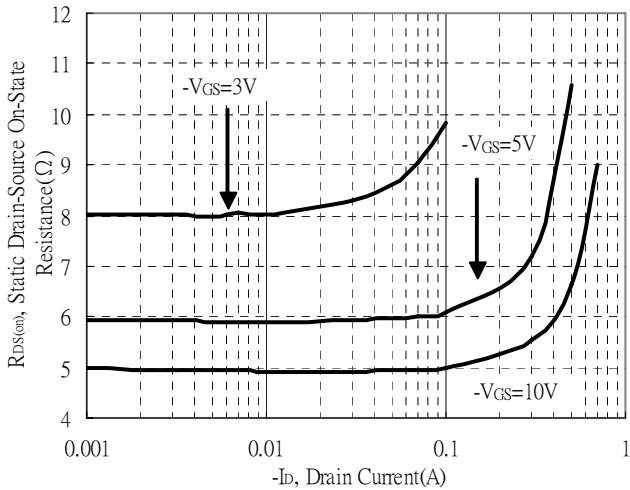

Reverse Drain Current vs Source-Drain Voltage

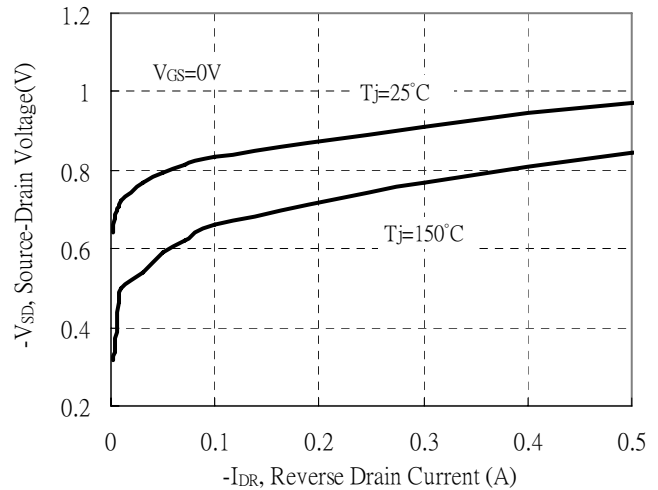

Static Drain-Source On-State Resistance vs Gate-Source Voltage

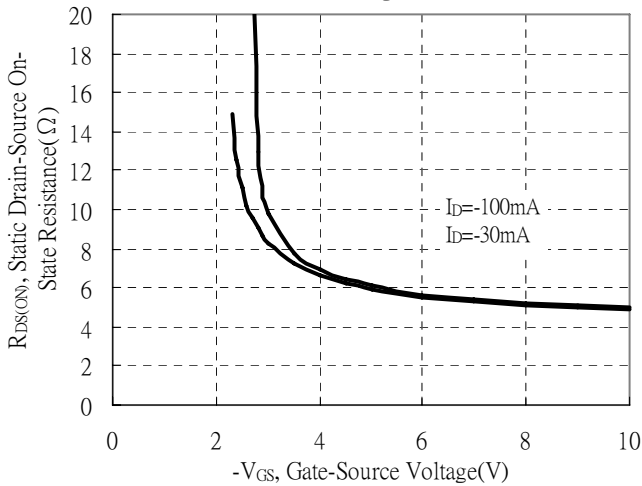

Drain-Source On-State Resistance vs Junction Temperature

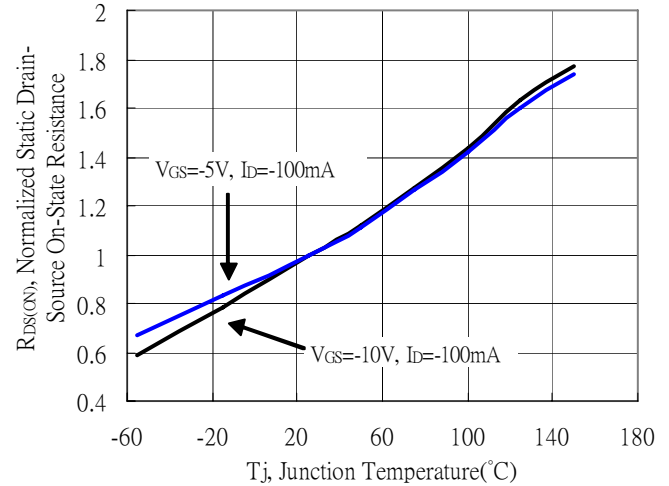

**Typical Characteristics(Cont.)**

Capacitance vs Drain-to-Source Voltage

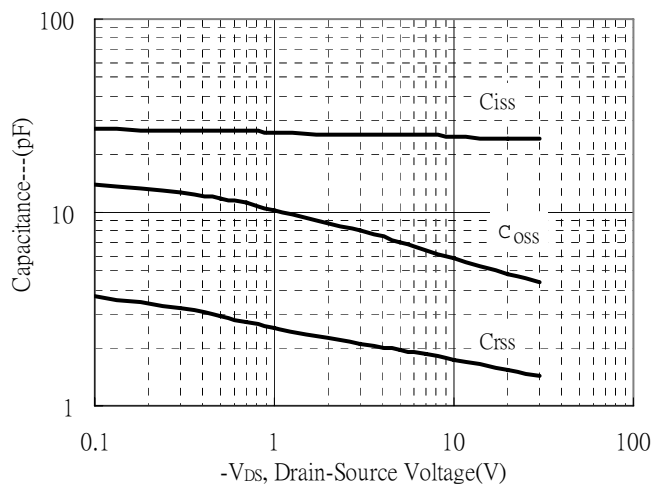

Threshold Voltage vs Junction Temperature

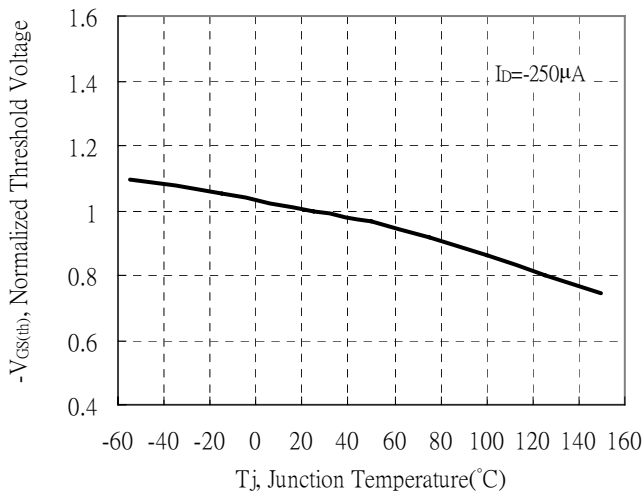

Single Pulse Power Rating, Junction to Ambient  
 (Note on page 2)

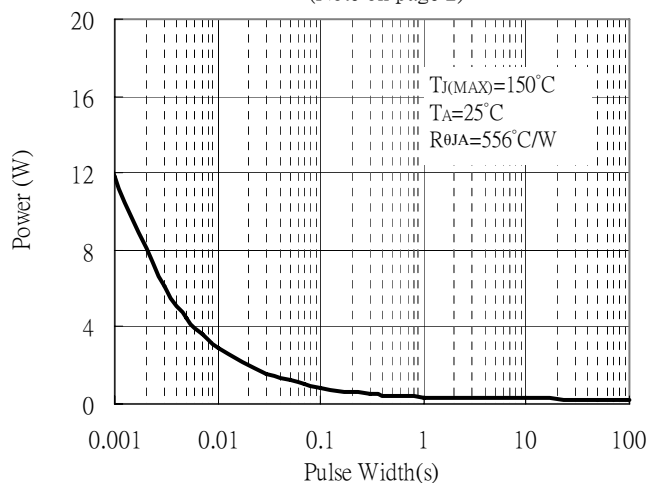

Gate Charge Characteristics

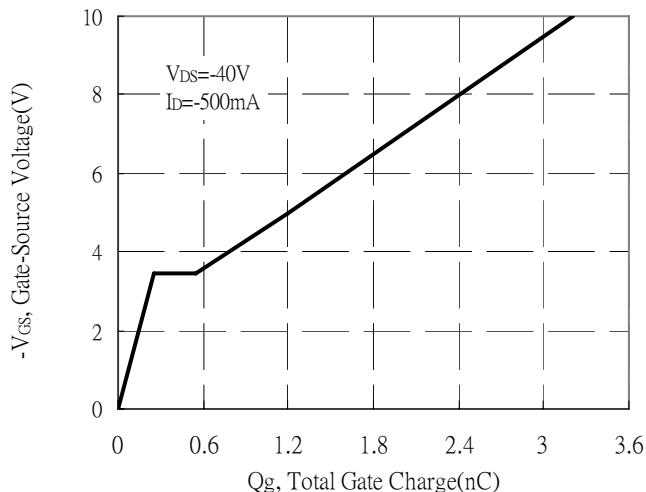

Maximum Safe Operating Area

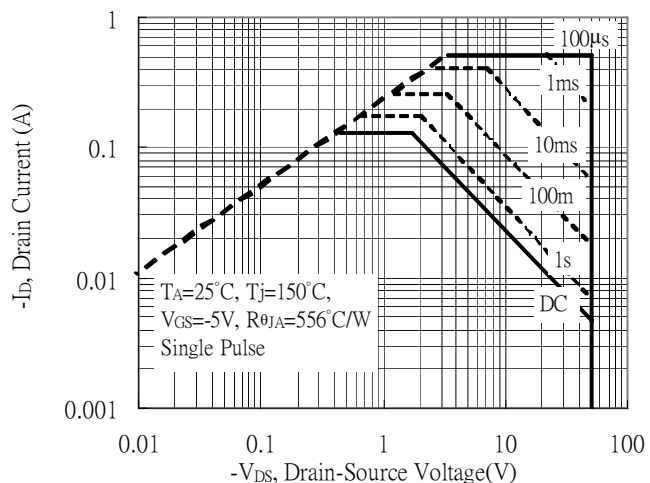

Maximum Drain Current vs Junction Temperature

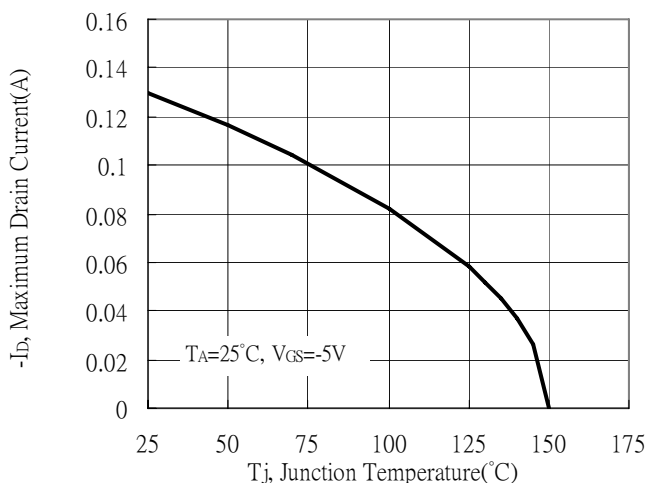

**Typical Characteristics(Cont.)**

Typical Transfer Characteristics

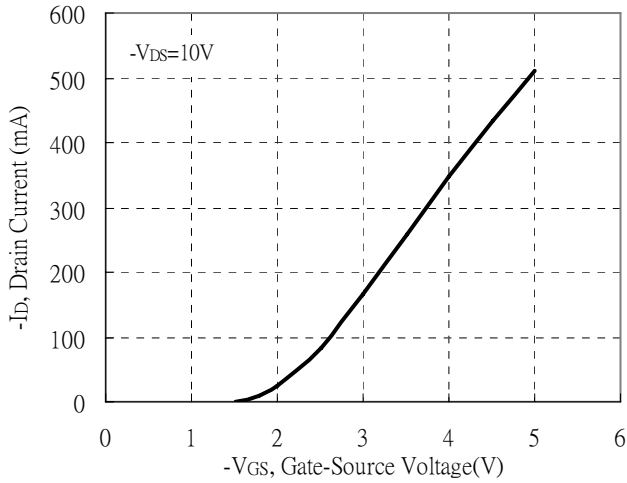

Power Derating Curve

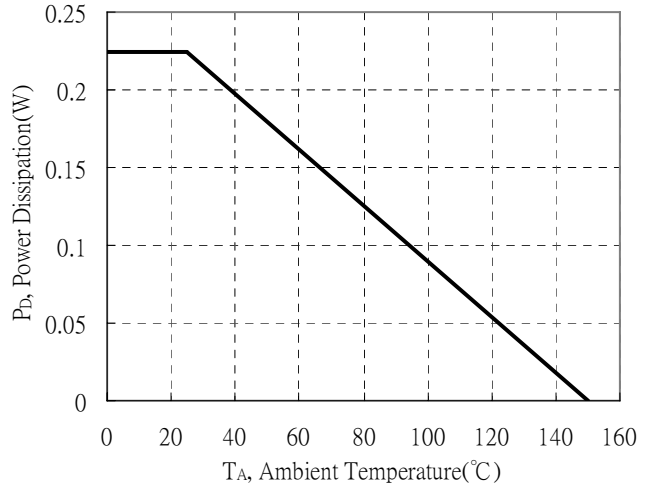

Transient Thermal Response Curves

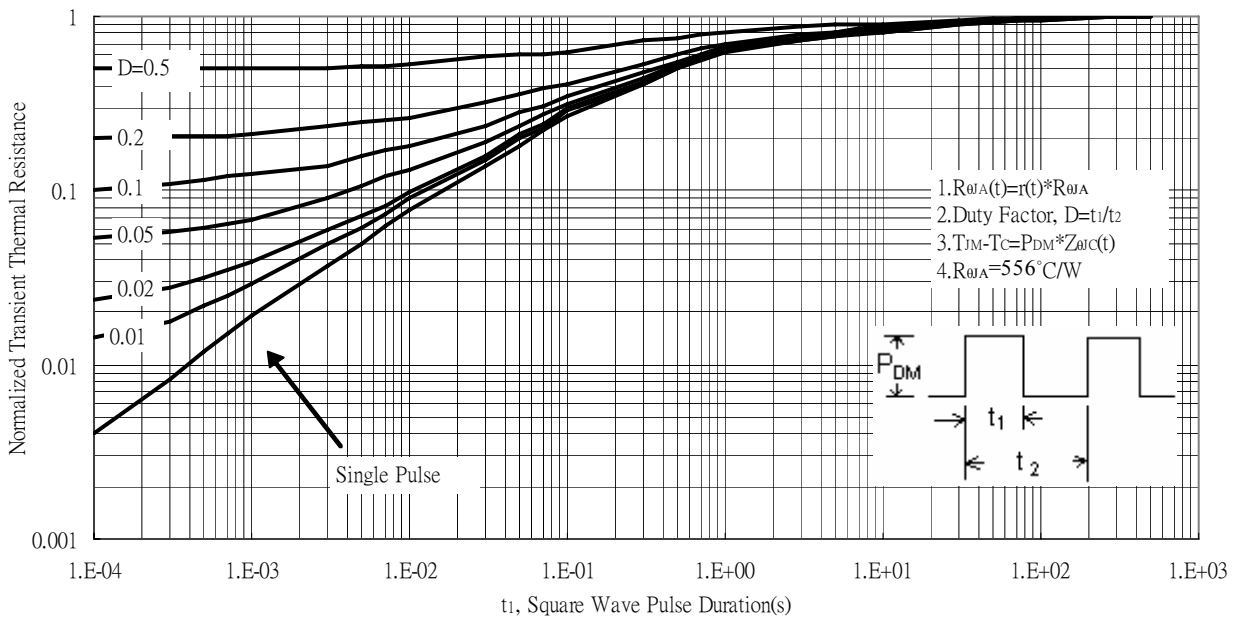

### Reel Dimension

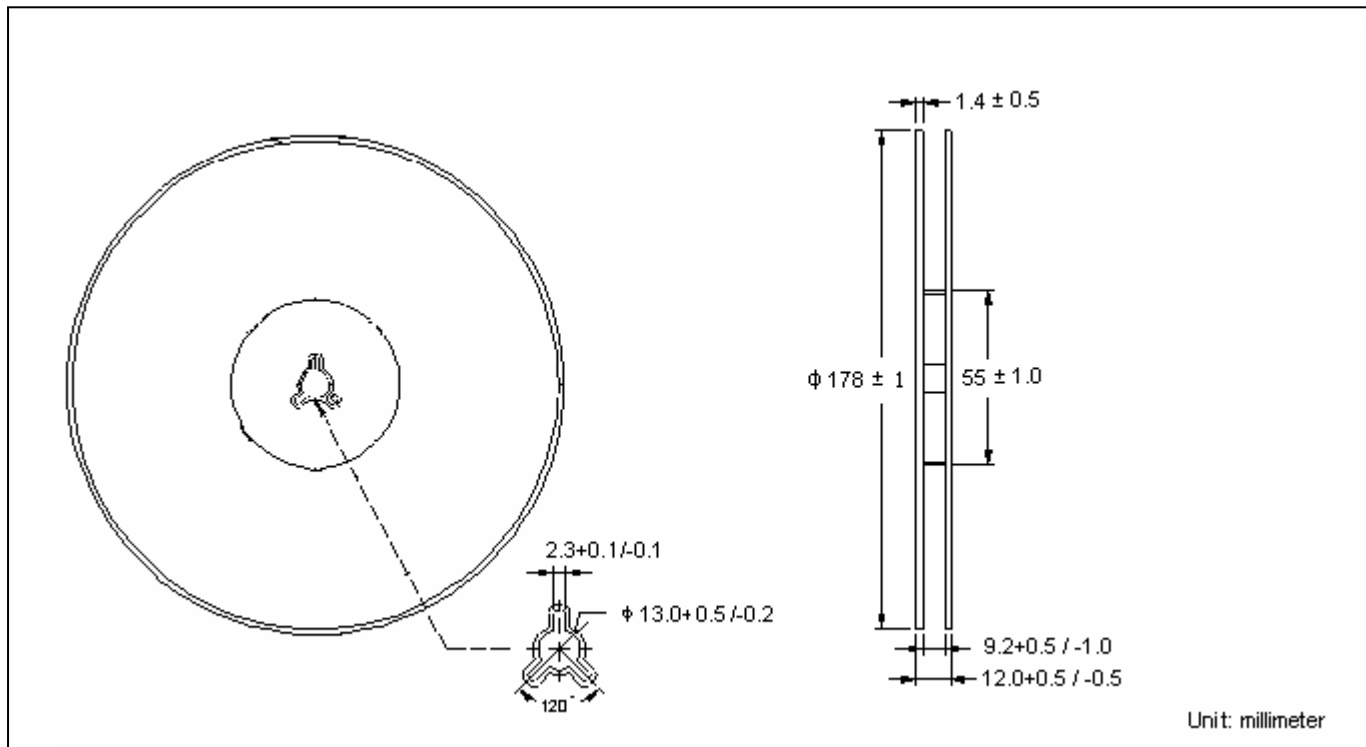

### Carrier Tape Dimension

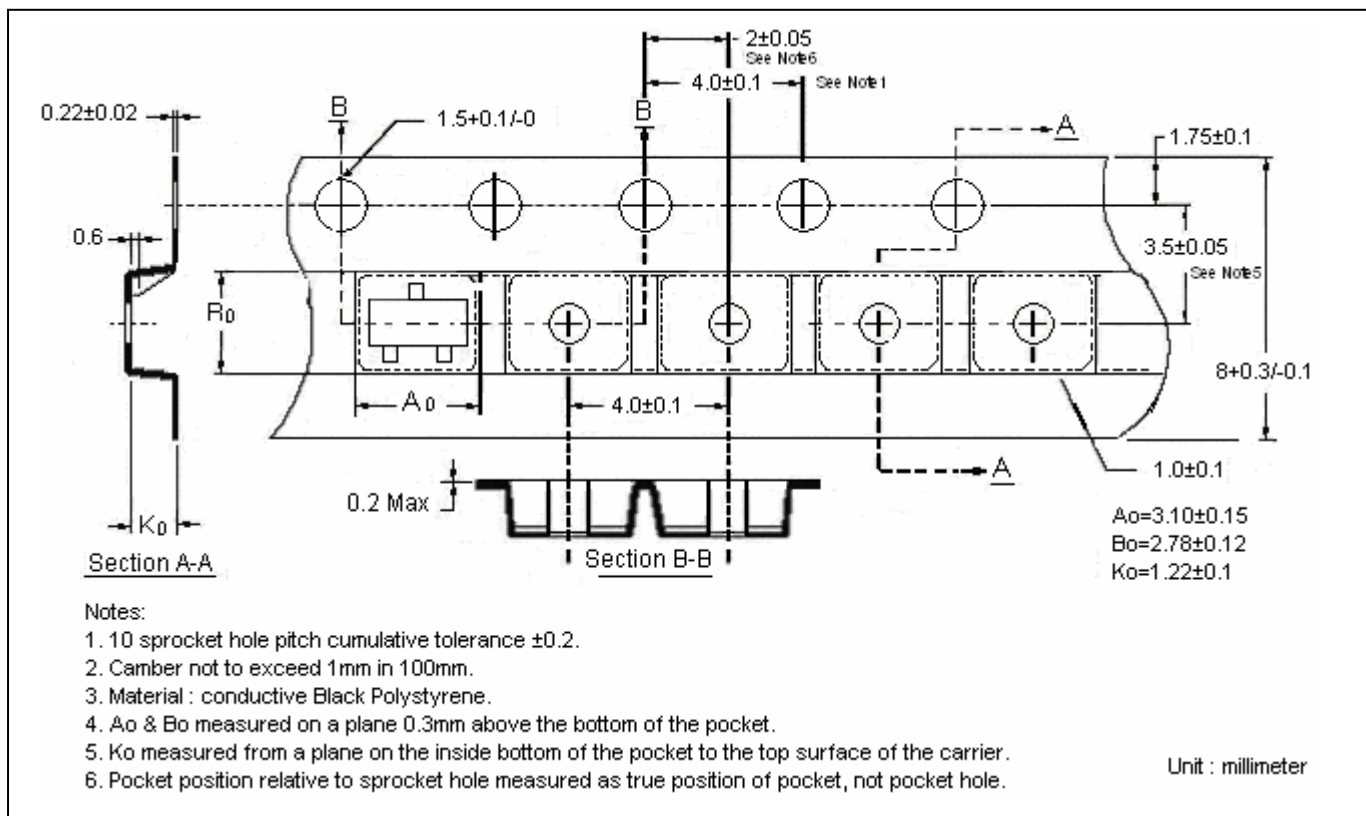

**Recommended wave soldering condition**

Product	Peak Temperature	Soldering Time
Pb-free devices	260 +0/-5 °C	5 +1/-1 seconds

**Recommended temperature profile for IR reflow**

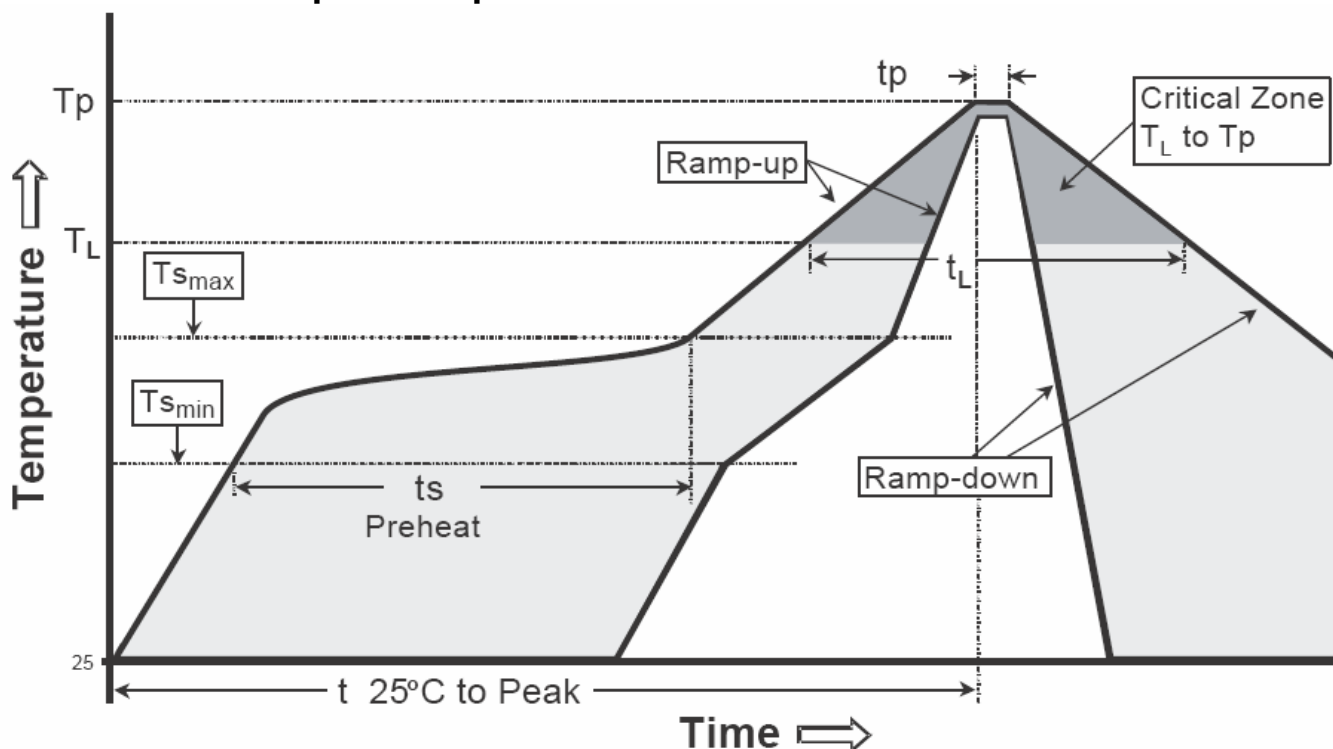

Profile feature	Sn-Pb eutectic Assembly	Pb-free Assembly
Average ramp-up rate (Tsmax to Tp)	3°C/second max.	3°C/second max.
Preheat		
-Temperature Min(Ts min)	100°C	150°C
-Temperature Max(Ts max)	150°C	200°C
-Time(ts min to ts max)	60-120 seconds	60-180 seconds
Time maintained above:		
-Temperature (Tl)	183°C	217°C
- Time (tl)	60-150 seconds	60-150 seconds
Peak Temperature(Tp)	240 +0/-5 °C	260 +0/-5 °C
Time within 5°C of actual peak temperature(tp)	10-30 seconds	20-40 seconds
Ramp down rate	6°C/second max.	6°C/second max.
Time 25 °C to peak temperature	6 minutes max.	8 minutes max.

Note : All temperatures refer to topside of the package, measured on the package body surface.

## SOT-23 Dimension

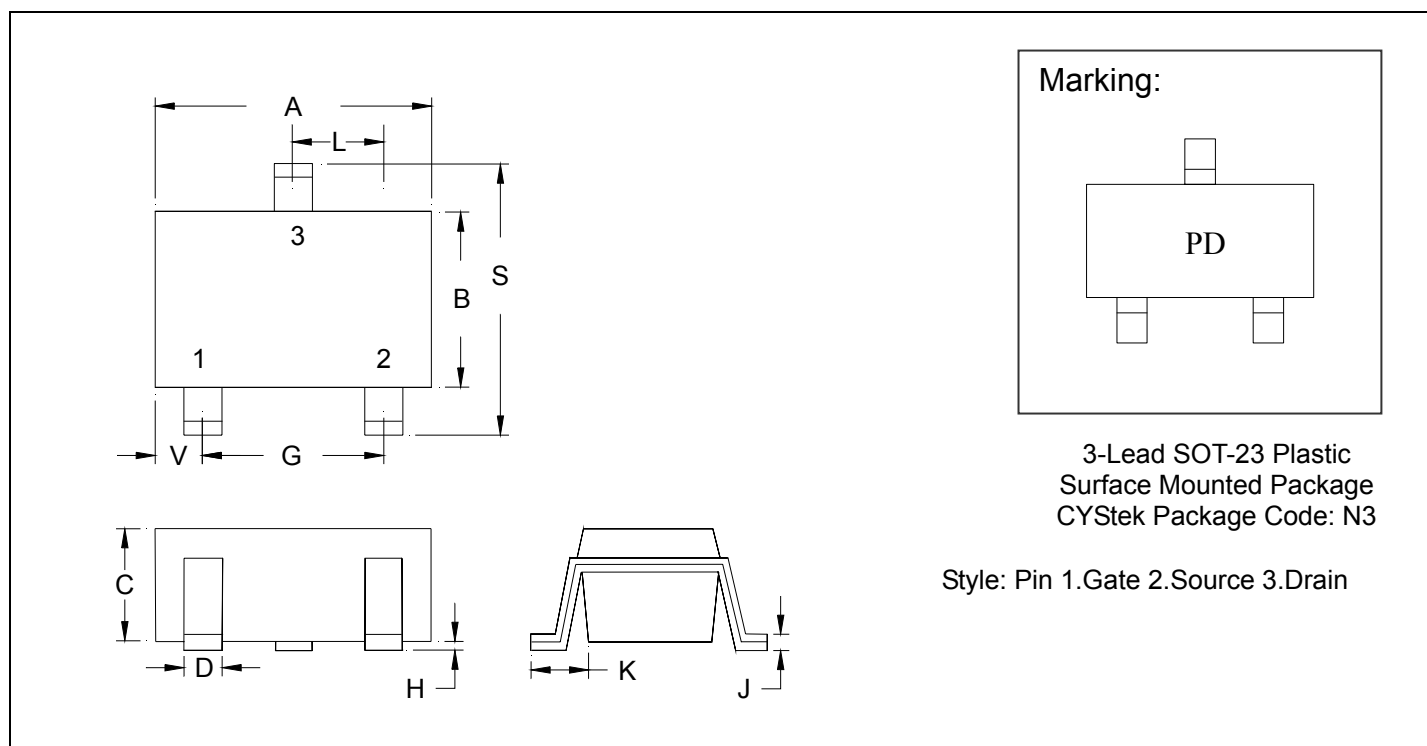

\*: Typical

DIM	Inches		Millimeters		DIM	Inches		Millimeters	
	Min.	Max.	Min.	Max.		Min.	Max.	Min.	Max.
A	0.1102	0.1204	2.80	3.04	J	0.0032	0.0079	0.08	0.20
B	0.0472	0.0669	1.20	1.70	K	0.0118	0.0266	0.30	0.67
C	0.0335	0.0512	0.89	1.30	L	0.0335	0.0453	0.85	1.15
D	0.0118	0.0197	0.30	0.50	S	0.0830	0.1161	2.10	2.95
G	0.0669	0.0910	1.70	2.30	V	0.0098	0.0256	0.25	0.65
H	0.0000	0.0040	0.00	0.10					

**Notes:** 1.Controlling dimension: millimeters.  
 2.Maximum lead thickness includes lead finish thickness, and minimum lead thickness is the minimum thickness of base material.  
 3.If there is any question with packing specification or packing method, please contact your local CYStek sales office.

**Material:**

- Lead: Pure tin plated.
- Mold Compound: Epoxy resin family, flammability solid burning class: UL94V-0.

**Important Notice:**

- All rights are reserved. Reproduction in whole or in part is prohibited without the prior written approval of CYStek.
- CYStek reserves the right to make changes to its products without notice.
- CYStek **semiconductor products are not warranted to be suitable for use in Life-Support Applications, or systems.**
- CYStek assumes no liability for any consequence of customer product design, infringement of patents, or application assistance.