

MCM2716

2048 x 8-BIT UV ERASABLE PROM

The MCM2716 is a 16,384-bit Erasable and Electrically Reprogrammable PROM designed for system debug usage and similar applications requiring nonvolatile memory that could be reprogrammed periodically. The transparent lid on the package allows the memory content to be erased with ultraviolet light.

For ease of use, the device operates from a single power supply and has a static power-down mode. Pin-for-pin mask programmable ROMs are available for large volume production runs of systems initially using the MCM2716.

- Single 5 V Power Supply
- Automatic Power-down Mode (Standby)
- Organized as 2048 Bytes of 8 Bits
- TTL Compatible During Read and Program
- Maximum Access Time = 450 ns MCM2716
- Pin Equivalent to Intel's 2716
- Pin Compatible to MCM68A316E
- Output Enable Active Level is User Selectable

MOS

(N-CHANNEL, SILICON-GATE)

2048 x 8-BIT UV ERASABLE PROM

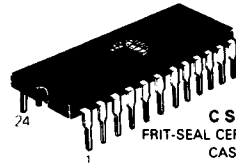

C SUFFIX
FRIT-SEAL CERAMIC PACKAGE
CASE 623A

L SUFFIX CERAMIC PACKAGE
ALSO AVAILABLE — CASE 716

PIN ASSIGNMENT

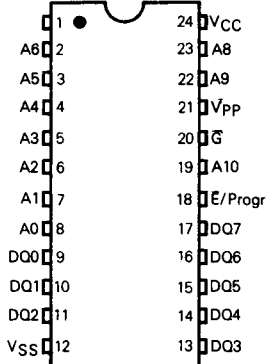

MOTOROLA'S PIN-COMPATIBLE EPROM FAMILY

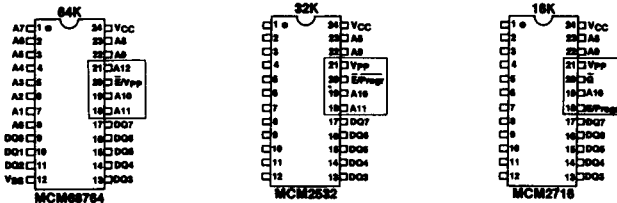

MOTOROLA'S PIN-COMPATIBLE ROM FAMILY

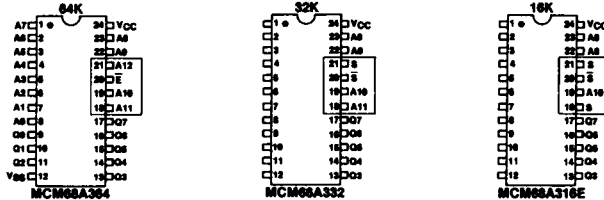

INDUSTRY STANDARD PINOUTS

*Pin Names

- A Address
- DQ Data Input/Output
- E/Program Chip Enable/Program
- G Output Enable

*New industry standard nomenclature

EPROM

MCM2716

www.DataSheet4U.com

ABSOLUTE MAXIMUM RATINGS

Rating	Value	Unit
Temperature Under Bias ($V_{PP} = 5\text{ V}$)	-10 to +80	°C
Operating Temperature Range	0 to +70	°C
Storage Temperature	-65 to +125	°C
All Input or Output Voltages with Respect to V_{SS}	+6 to -0.3	V
V_{PP} Supply Voltage with Respect to V_{SS}	+28 to -0.3	V

This device contains circuitry to protect the inputs against damage due to high static voltages or electric fields; however, it is advised that normal precautions be taken to avoid application of any voltage higher than maximum rated voltages to this high-impedance circuit.

NOTE: Permanent device damage may occur if ABSOLUTE MAXIMUM RATINGS are exceeded. Functional operation should be restricted to RECOMMENDED OPERATING CONDITIONS. Exposure to higher than recommended voltages for extended periods of time could affect device reliability.

MODE SELECTION

Mode	Pin Number					
	9-11, 13-17 DQ	12 V_{SS}	18 \bar{E}/Progr	20 \bar{G}^*	21 V_{PP}	24 V_{CC}
Read	Data Out	V_{SS}	V_{IL}	V_{IL}	V_{CC}^*	V_{CC}
Output Disable	High Z	V_{SS}	Don't Care	V_{IH}	V_{CC}^*	V_{CC}
Standby	High Z	V_{SS}	V_{IH}	Don't Care	V_{CC}	V_{CC}
Program	Data In	V_{SS}	Pulsed V_{IL} to V_{IH}	V_{IH}	V_{PPH}	V_{CC}
Program Verify	Data Out	V_{SS}	V_{IL}	V_{IL}	V_{PPH}	V_{CC}
Program Inhibit	High Z	V_{SS}	V_{IL}	V_{IH}	V_{PPH}	V_{CC}

*In the Read Mode if $V_{PP} \geq V_{IH}$, then \bar{G} (active low)
 $V_{PP} \leq V_{IL}$, then G (active high)

BLOCK DIAGRAM

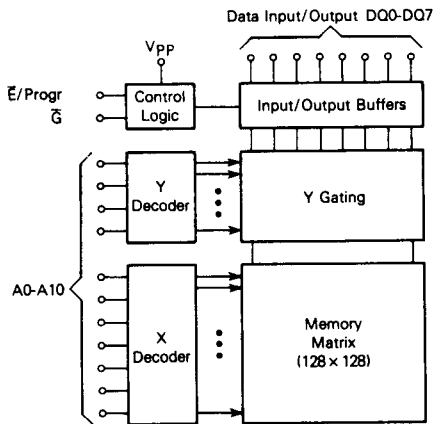
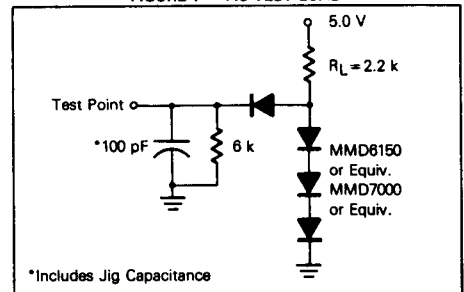

FIGURE 1 — AC TEST LOAD



EPROM

MCM2716

www.DataSheet4U.com CAPACITANCE (f = 1.0 MHz, T_A = 25°C, periodically sampled rather than 100% tested)

Characteristic	Symbol	Typ	Max	Unit
Input Capacitance (V _{in} = 0 V)	C _{in}	4.0	6.0	pF
Output Capacitance (V _{out} = 0 V)	C _{out}	8.0	12	pF

Capacitance measured with a Boonton Meter or effective capacitance calculated from the equation: $C = \frac{I\Delta t}{\Delta V}$

DC OPERATING CONDITIONS AND CHARACTERISTICS

(Full operating voltage and temperature range unless otherwise noted)

RECOMMENDED DC READ OPERATING CONDITIONS

Parameter	Symbol	Min	Nom	Max	Unit
Supply Voltage*	V _{CC}	4.75	5.0	5.25	V
	V _{pp}	4.75	5.0	5.25	
Input High Voltage	V _{IH}	2.0	—	V _{CC} + 1.0	V
Input Low Voltage	V _{IL}	-0.1	—	0.8	V

RECOMMENDED DC OPERATING CHARACTERISTICS

Characteristic	Condition	Symbol	MCM2716			Units
			Min	Typ	Max	
Address, \bar{G} and \bar{E} /Progr Input Sink Current	V _{in} = 5.25 V	I _{in}	—	—	10	μA
Output Leakage Current	V _{out} = 5.25 V	I _{LO}	—	—	10	μA
	\bar{G} = 5.0 V					
V _{CC} Supply Current (Standby) 2716	\bar{E} /Progr = V _{IH} \bar{G} = V _{IL}	I _{CC1}	—	—	25	mA
V _{CC} Supply Current (Active) 2716 (Outputs Open)	\bar{G} = \bar{E} /Progr = V _{IL}	I _{CC2}	—	—	100	mA
V _{pp} Supply Current*	V _{pp} = 5.25 V	I _{pp1}	—	—	5.0	mA
Output Low Voltage	I _{OL} = 2.1 mA	V _{OL}	—	—	0.45	V
Output High Voltage	I _{OH} = -400 μA	V _{OH}	2.4	—	—	V

*V_{CC} must be applied simultaneously or prior to V_{pp}. V_{CC} must also be switched off simultaneously with or after V_{pp}. With V_{pp} connected directly to V_{CC} during the read operation, the supply current would then be the sum of I_{pp1} and I_{CC}.

AC OPERATING CONDITIONS AND CHARACTERISTICS

(Full operating voltage and temperature range unless otherwise noted)

Input Pulse Levels 0.8 Volt and 2.2 Volts Input and Output Timing Levels 2.0 and 0.8 Volts
 Input Rise and Fall Times 20 ns Output Load See Figure 1

Characteristic	Condition	Symbol	MCM2716		Units
			Min	Max	
Address Valid to Output Valid	\bar{E} /Progr = \bar{G} = V _{IL}	t _{AVQV}	—	450	ns
\bar{E} /Progr to Output Valid	(Note 2)	t _{ELQV}	—	450	
Output Enable to Output Valid	\bar{E} /Progr = V _{IL}	t _{GLQV}	—	150	
\bar{E} /Progr to High Z Output	—	t _{EHQZ}	0	100	
Output Disable to High Z Output	\bar{E} /Progr = V _{IL}	t _{GHOZ}	0	100	
Data Hold from Address	\bar{E} /Progr = \bar{G} = V _{IL}	t _{AXDX}	0	—	

MCM2716

www.DataSheet4U.com

READ MODE TIMING DIAGRAMS ($\bar{E}/\text{Progr} = V_{IL}$)

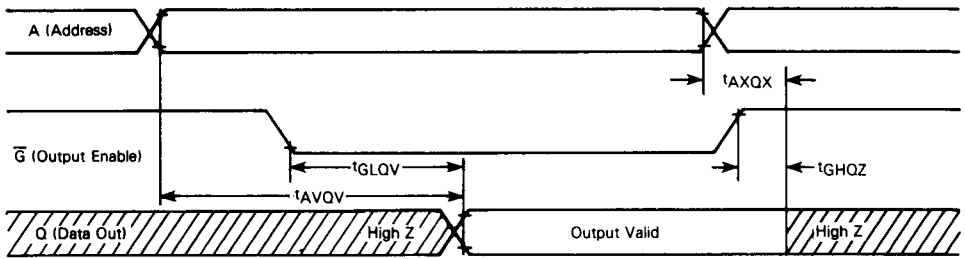

STANDBY MODE (Output Enable = V_{IL})

Standby Mode ($\bar{E}/\text{Progr} = V_{IH}$)

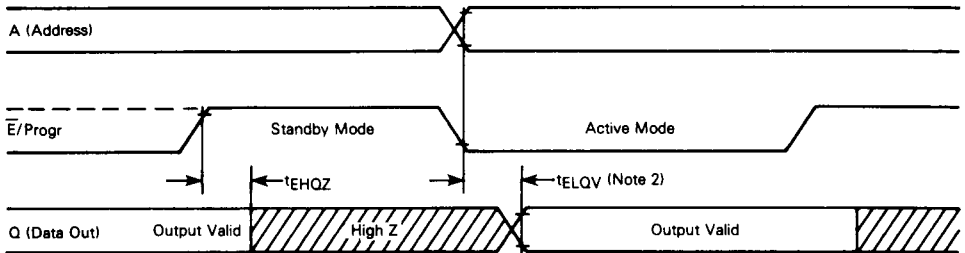

NOTE 2: t_{ELQV} is referenced to \bar{E}/Progr or stable address, whichever occurs last.

DC PROGRAMMING CONDITIONS AND CHARACTERISTICS

($T_A = 25^\circ\text{C} \pm 5^\circ\text{C}$)

RECOMMENDED PROGRAMMING OPERATING CONDITIONS

Parameter	Symbol	Min	Nom	Max	Unit
Supply Voltage	V_{CC}, V_{PPL} V_{PPH}	4.75 24	5.0 25	5.25 26	V
Input High Voltage for Data	V_{IH}	2.2	—	$V_{CC} + 1$	V
Input Low Voltage for Data	V_{IL}	-0.1	—	0.8	V

PROGRAMMING OPERATION DC CHARACTERISTICS

Characteristic	Condition	Symbol	Min	Typ	Max	Unit
Address, \bar{G} and \bar{E}/Progr Input Sink Current	$V_{in} = 5.25 \text{ V}/0.45 \text{ V}$	I_L	—	—	10	μA
V_{pp} Programming Pulse Supply Current ($V_{pp} = 25 \text{ V} \pm 1 \text{ V}$)	$\bar{E}/\text{Progr} = V_{IH}$	I_{PP2}	—	—	30	mA
V_{CC} Supply Current (Outputs Open)	—	I_{CC}	—	—	160	mA

AC PROGRAMMING OPERATING CONDITIONS AND CHARACTERISTICS

Characteristic	Symbol	Min	Max	Unit
Address Setup Time	t_{AVEH}	2.0	—	μs
Output Enable High to Program Pulse	t_{GHEH}	2.0	—	μs
Data Setup Time	t_{DVEH}	2.0	—	μs
Address Hold Time	t_{ELAX}	2.0	—	μs
Output Enable Hold Time	t_{ELGL}	2.0	—	μs
Data Hold Time	t_{ELOZ}	2.0	—	μs
V_{pp} Setup Time	t_{PHEH}	0	—	ns
V_{pp} to Enable Low Time	t_{ELPL}	0	—	ns
Output Disable to High Z Output	t_{GHQZ}	0	150	ns
Output Enable to Valid Data ($\bar{E}/\text{Progr} = V_{IL}$)	t_{GLQV}	—	150	ns
Program Pulse Width	t_{EHEL}	1*	55	ms
Program Pulse Rise Time	t_{PR}	5	—	ns
Program Pulse Fall Time	t_{PF}	5	—	ns

*If shorter than 45 ms (min) pulses are used, the same number of pulses should be applied after the specific data has been verified to ensure that good programming levels have been written.

EPROM

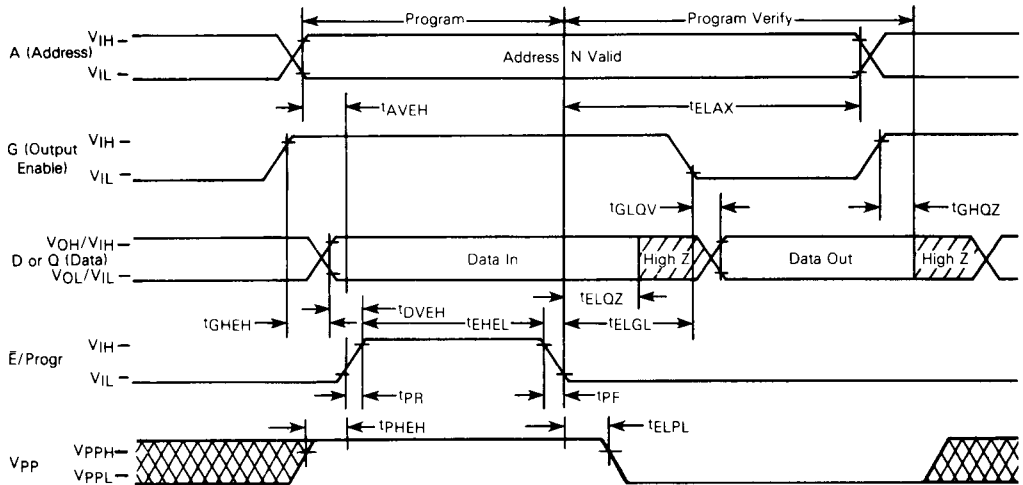

PROGRAMMING INSTRUCTIONS

Before programming, the memory should be submitted to a full ERASE operation to ensure every bit in the device is in the "1" state (represented by Output High). Data are entered by programming zeros (Output Low) into the required bits. The words are addressed the same way as in the READ operation. A programmed "0" can only be changed to a "1" by ultraviolet light erasure.

To set the memory up for Program Mode, the V_{pp} input (Pin 21) should be raised to +25 V. The V_{CC} supply voltage is the same as for the Read operation and G is at V_{IH} . Programming data is entered in 8-bit words through the data out (DQ) terminals. Only "0's" will be programmed when "0's" and "1's" are entered in the 8-bit data word.

After address and data setup, a program pulse (V_{IL} to V_{IH}) is applied to the $\bar{E}/Progr$ input. A program pulse is applied to each address location to be programmed. To minimize programming time, a 2 ms pulse width is recommended. The maximum program pulse width is 55 ms; therefore, programming must not be attempted with a dc signal applied to the $\bar{E}/Progr$ input.

Multiple MCM2716s may be programmed in parallel by connecting together like inputs and applying the program pulse to the $\bar{E}/Progr$ inputs. Different data may be programmed into multiple MCM2716s connected in parallel by using the PROGRAM INHIBIT mode. Except for the $\bar{E}/Progr$ pin, all like inputs (including Output Enable) may be common.

The PROGRAM VERIFY mode with V_{pp} at 25 V is used to determine that all programmed bits were correctly programmed.

READ OPERATION

After access time, data is valid at the outputs in the READ mode. With stable system addresses, effectively faster access time can be obtained by gating the data onto the bus with Output Enable.

The Standby mode is available to reduce active power dissipation. The outputs are in the high impedance state when the $\bar{E}/Progr$ input pin is high (V_{IH}) independent of the Output Enable input.

ERASING INSTRUCTIONS

The MCM2716 can be erased by exposure to high intensity shortwave ultraviolet light, with a wavelength of 2537 angstroms. The recommended integrated dose (i.e., UV-intensity X exposure time) is 15 Ws/cm². As an example, using the "Model 30-000" UV-Eraser (Turner Designs, Mountain View, CA 94043) the ERASE-time is 36 minutes. The lamps should be used without shortwave filters and the MCM2716 should be positioned about one inch away from the UV-tubes.

RECOMMENDED OPERATING PROCEDURES

After erasure and reprogramming of the EPROM, it is recommended that the quartz window be covered with an opaque self-adhesive cover. It is important that the self-adhesive cover not leave any residue on the quartz if it is removed to allow another erasure.

EPROM

TIMING PARAMETER ABBREVIATIONS

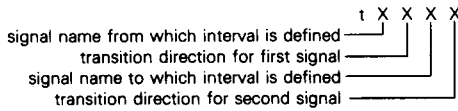

The transition definitions used in this data sheet are:

- H = transition to high
- L = transition to low
- V = transition to valid
- X = transition to invalid or don't care
- Z = transition to off (high impedance)

TIMING LIMITS

The table of timing values shows either a minimum or a maximum limit for each parameter. Input requirements are specified from the external system point of view. Thus, address setup time is shown as a minimum since the system must supply at least that much time (even though most devices do not require it). On the other hand, responses from the memory are specified from the device point of view. Thus, the access time is shown as a maximum since the device never provides data later than that time.

WAVEFORMS

Waveform Symbol	Input	Output
	Must Be Valid	Will Be Valid
	Change From H to L	Will Change From H to L
	Change From L to H	Will Change From L to H
	Don't Care: Any Change Permitted	Changing: State Unknown
		High Impedance

EPROM