

**3-Phase POW-R-PAK™
 IGBT Assembly
 150 Amperes/1200 Volts**

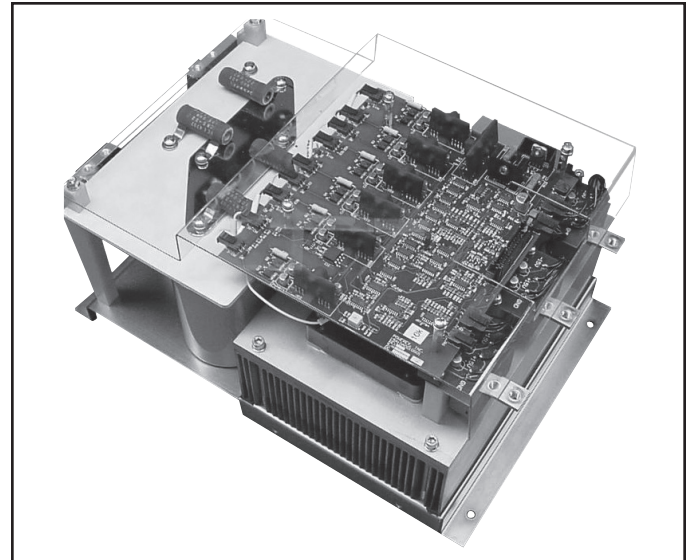
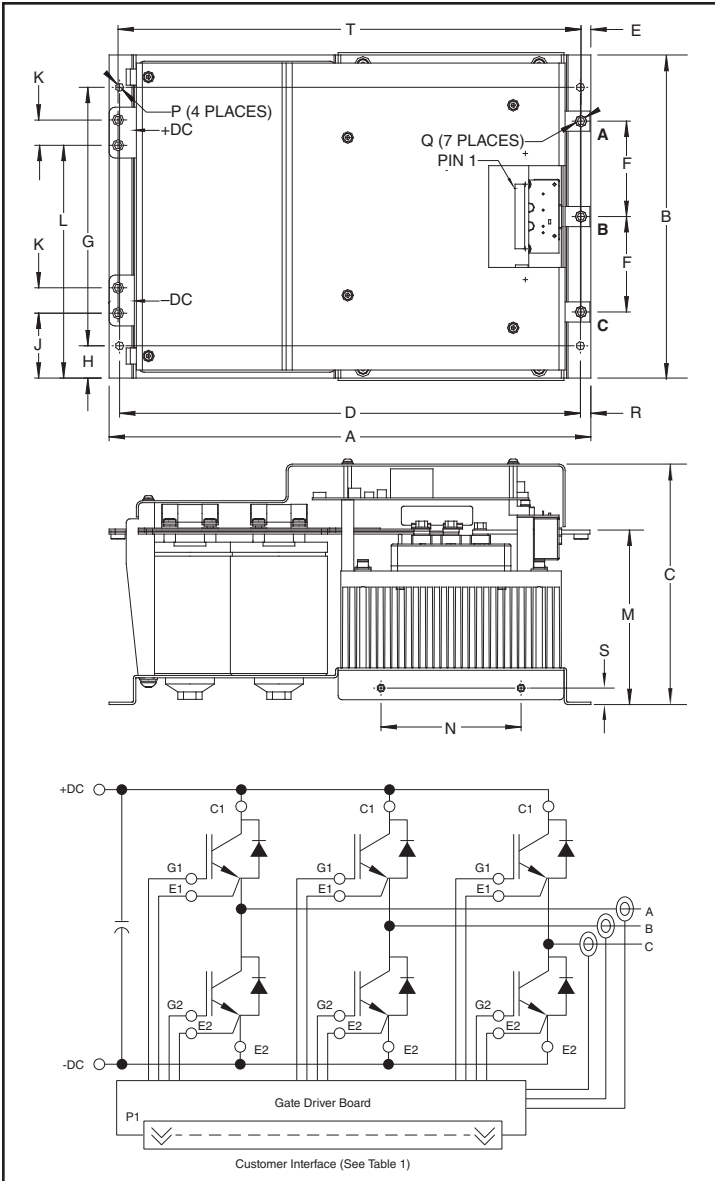

Description:

The Powerex POW-R-PAK™ is a configurable IGBT based power assembly that may be used as a converter, chopper, half or full bridge, or three phase inverter for motor control, power supply, UPS or other power conversion applications.

The power assembly is mounted on a forced air-cooled heatsink and features state-of-the-art Powerex IGBTs with low conduction and low switching losses for high efficiency operation. The POW-R-PAK™ includes a low inductance laminated bus structure, optically isolated gate drive interfaces, isolated gate drive power supplies, and a DC-link capacitor bank. The control board provides a simple user interface along with built-in protection features including overvoltage, undervoltage lockout, overcurrent, overtemperature, and short circuit detection.

Depending on application characteristics, the POW-R-PAK™ is suitable for operation with DC bus voltages up to 800VDC and switching frequencies below 20kHz.

Features:

- High performance IGBT inverter bridge
- Integrated gate drive with fault monitoring and protection
- System status / troubleshooting LEDs to verify or monitor proper operation
- Isolated gate drive power supplies
- Low inductance laminated bus
- Output current measurement and feedback
- Superior short circuit detection & shoot through prevention

Outline Drawing and Circuit Diagram

Dim.	Inches	mm	Dim.	Inches	mm
A	14.9	378.4	K	0.79	20.0
B	10.15	257.8	L	7.20	183.0
C	7.4	193.0	M	5.4	137.2
D	14.25	362.0	N	4.33	110.0
E	0.3	7.7	P	0.256 Dia.	6.5 Dia.
F	2.95	75.0	Q	M6 Metric	M6
G	8.0	203.2	R	0.32	8.2
H	1.0	25.4	S	0.51	12.9
J	2.01	51.0	T	14.32	363.6



Powerex, Inc., 173 Pavilion Lane, Youngwood, Pennsylvania 15697 (724) 925-7272 www.pwr.com

PP150T120-ND
3-Phase POW-R-PAK™ IGBT Assembly
150 Amperes/1200 Volts

Absolute Maximum Ratings, $T_j = 25^\circ\text{C}$ unless otherwise specified

Module

Characteristics	Symbol	Rating	Units
IGBT Junction Temperature	T_j	-40 to +150	$^\circ\text{C}$
Storage Temperature	T_{stg}	-40 to +65	$^\circ\text{C}$
Operating Temperature	T_{op}	-20 to +60	$^\circ\text{C}$
Voltage Applied to DC Terminals	V_{CC}	900	Volts
Isolation Voltage, Main Terminals to Heatsink	V_{iso}	2500	Volts

IGBT Part

Characteristics	Symbol	Rating	Units
Collector Current (DC, $T_C = 83^\circ\text{C}$)	I_C	150	Amperes
Peak Collector Current	I_{CM}	300	Amperes
Emitter Current ($T_C = 25^\circ\text{C}$)	I_E	150	Amperes
Peak Emitter Current	I_{EM}	300	Amperes
Maximum Collector Dissipation ($T_j < 150^\circ\text{C}$ per Module)	P_C	960	Watts

Interface Board

Characteristics	Symbol	Rating	Units
Unregulated +24V Power Supply Input	—	30	Volts
IGBT Command Signal Input Voltage	—	20	Volts
Fault Output Supply Voltage	—	30	Volts
Fault Output Current	—	50	mA

PP150T120-ND
3-Phase POW-R-PAK™ IGBT Assembly
 150 Amperes/1200 Volts

Electrical Characteristics, $T_j = 25^\circ\text{C}$ unless otherwise specified

IGBT Part

Characteristics	Symbol	Test Conditions	Min.	Typ.	Max.	Units
Collector Cutoff Current	I_{CES}	$V_{CE} = V_{CES}, V_{GE} = 0V$	—	—	1.0	mA
Collector-Emitter Saturation Voltage	$V_{CE(sat)}$	$I_C = 150A, T_j = 25^\circ\text{C}$	—	2.1	3.0	Volts
		$I_C = 150A, T_j = 125^\circ\text{C}$	—	2.4	—	Volts
Emitter-Collector Voltage	V_{EC}	$I_E = 150A$	—	—	3.8	Volts
Turn-on Delay Time	$t_{d(on)}$		—	—	130	Ns
Rise Time	t_r	$V_{CC} = 600V, I_C = 150A, V_{GE} = \pm 15V,$	—	—	100	Ns
Turn-off Delay Time	$t_{d(off)}$	$R_G = 1.6\Omega, \text{ Inductive Load}$	—	—	450	Ns
Fall Time	t_f		—	—	350	Ns
Diode Reverse Recovery Time	t_{rr}	$I_E = 150A$	—	—	150	Ns
Diode Reverse Recovery Charge	Q_{rr}	$I_E = 150A$	—	9.0	—	μC

Interface Board

Characteristics	Min.	Typ.	Max.	Units
Unregulated +24V Power Supply Input	20	24	30	Volts
Power Supply Current Consumption	—	—	800	mA
IGBT Command Signal ON Threshold	12	15	—	Volts
IGBT Command Signal OFF Threshold	—	0	2	Volts
IGBT Command Signal Input Impedance	—	10	—	k Ω
IGBT Command Signal Input Capacitance	—	1	—	nF
Dead Time	—	3.0	—	μs

Feedback Signal and Fault Characteristics

Characteristics	Min.	Typ.	Max.	Units
Output Over Current Trip	—	250	—	Amperes
Heatsink Over Temperature Trip	—	95	—	$^\circ\text{C}$
Bus Over Voltage Trip	—	920	—	Volts
Power Supply Under Voltage Trip	—	18.9	—	Volts
Fault Reset Time	—	9	—	μs
Heatsink Temperature Feedback	—	0.1 V/ $^\circ\text{C}$	—	Volts
Output Current Feedback (Bipolar)	—	± 0.01 V/Amp	—	Volts
DC Link Feedback	—	0.01 V/V	—	Volts



Powerex, Inc., 173 Pavilion Lane, Youngwood, Pennsylvania 15697 (724) 925-7272 www.pwr.com

PP150T120-ND
3-Phase POW-R-PAK™ IGBT Assembly
150 Amperes/1200 Volts

Electrical Characteristics, $T_j = 25^\circ\text{C}$ unless otherwise specified

Other Electrical Component Specifications

Characteristics	Min.	Typ.	Max.	Units
DC Link Capacitor Bank				
Total Nominal Capacitance	—	2300	—	μF
Nominal Ripple Current Rating per Capacitor (@ 85°C , 120Hz)	—	11.6	—	A_{RMS}
Nominal Total Voltage Rating	—	1000	—	Volts
Minimum Life @ Nominal Ripple Current (80°C)	—	10	—	khrs
Output Current Sensor				
Primary Current Measuring Range	—	± 200	—	Amperes
Accuracy (@ I_{PN} , 25°C)	—	$< \pm 1$	—	%
Linearity Error	—	$< \pm 1$	—	%
Response Time	—	< 5	—	μs
Bandwidth (-3 dB)	DC	—	25	kHz

Thermal Characteristics, $T_j = 25^\circ\text{C}$ unless otherwise specified

Characteristics	Symbol	Test Conditions	Min.	Typ.	Max.	Units
IGBT Thermal Resistance, Junction-to-Case	$R_{\text{th}(j-c)Q}$	Per IGBT, 1/2 Module	—	—	0.13	$^\circ\text{C}/\text{W}$
FWD Thermal Resistance, Junction-to-Case	$R_{\text{th}(j-c)D}$	Per FWD, 1/2 Module	—	—	0.23	$^\circ\text{C}/\text{W}$
Contact Thermal Resistance	$R_{\text{th}(c-f)}$	Per 1/2 Module	—	0.022	—	$^\circ\text{C}/\text{W}$
Heatsink Thermal Resistance	$R_{\text{th}(f-a)}$	286 CFM Airflow	—	0.037	—	$^\circ\text{C}/\text{W}$

Mechanical Characteristics, $T_j = 25^\circ\text{C}$ unless otherwise specified

Characteristics	Min.	Typ.	Max.	Units
Mounting Torque, Output Power Terminals	—	75	90	in-lb
Mounting Torque, DC Bus Terminals	—	130	150	in-lb
Weight	—	39	—	lb

Relevant Standards

UL508C: Power Conversion Equipment

EN50178: Electronic Equipment for Use in Power Installations

PP150T120-ND
3-Phase POW-R-PAK™ IGBT Assembly
 150 Amperes/1200 Volts

Interface Board Signal Definitions (Table 1)

Pin	Signal Name	Description
1	Shield	Internally Connected to PGND
2	Gate 1 Neg.	0-15V Signal Controlling, Lower IGBT, HIGH = IGBT on
3	Leg 1 Error ¹	Open Collector Output, External Pull-up Resistor Required LOW = No Error; HIGH = Phase A Over Current or Short Circuit OR Power Supply UV
4	Gate 1 Pos.	0-15V Signal Controlling, Upper IGBT, HIGH = IGBT on
5	Gate 2 Neg.	0-15V Signal Controlling, Lower IGBT, HIGH = IGBT on
6	Leg 2 Error ¹	Open Collector Output, External Pull-up Resistor Required LOW = No Error; HIGH = Phase A Over Current or Short Circuit OR Power Supply UV
7	Gate 2 Pos.	0-15V Signal Controlling, Upper IGBT, HIGH = IGBT on
8	Gate 3 Neg.	0-15V Signal Controlling, Lower IGBT, HIGH = IGBT on
9	Leg 3 Error ¹	Open Collector Output, External Pull-up Resistor Required LOW = No Error; HIGH = Phase A Over Current or Short Circuit OR Power Supply UV
10	Gate 3 Pos.	0-15V Signal Controlling, Upper IGBT, HIGH = IGBT on
11	Over Temperature ¹	Open Collector Output, External Pull-up Resistor Required LOW = No Error; HIGH = Heatsink OT
12	External Fault Reset	Active Low: Must be High for Operation; Low for 10microseconds to Reset Faults ³
13	DC Link Voltage	Analog Voltage Feedback of DC Link Voltage
14	24 VDC Input Power	20-30 VDC Input Power Supply
15	24 VDC Input Power	20-30 VDC Input Power Supply
16	N/C	No Connect - Do Not Ground
17	N/C	No Connect - Do Not Ground
18	PGND	Ground Reference for 24 VDC Power Supply
19	PGND	Ground Reference for 24 VDC Power Supply
20	Heatsink Temperature	Analog Voltage Representation of Heatsink Temperature
21	AGND ²	Tied to Pins 10 and 11
22	I _{OUT} Phase A	Analog Voltage Representation of Output Current
23	AGND ²	Tied to Pins 10 and 11
24	I _{OUT} Phase B	Analog Voltage Representation of Output Current
25	AGND ²	Tied to Pins 10 and 11
25	I _{OUT} Phase C	Analog Voltage Representation of Output Current

1. Open collectors can be pulled up to 30V max. and sink 50mA continuous.
 2. AGND signals to be used for analog feedback signals (i.e. twisted pair with I_{OUT} Phase A).
 3. On the board is a jumper that enables fault reset by bringing all leg control signals low for 10 microseconds (default).

Interface Board Connector

Description	Symbol	Type	Manufacturer
Gate Drive Board Interface Header	P1	0.100" x 0.100" Latching Header, 26 Pin	3M# 3429-6002 or Equivalent
Recommended Mating Socket	—	0.100" x 0.100" IDC Socket, 26 Pin	3M# 3499-7600 or Equivalent
Recommended Strain Relief	—	Plastic Strain Relief	3M# 3448-3026 or Equivalent