

## 1.6GHz ON/OFF Function LNA

### GENERAL DESCRIPTION

The XC2408A816UR-G is an ultra-low-noise amplifier (LNA) with low operating voltage, low noise figure (NF), low power consumption using CMOS process, The XC2408 is designed for GPS band frequency (1.6GHz).

The IC's internal circuit can be placed in stand-by mode via the CE function, In the stand-by mode, consumption current is greatly reduced and there is no need to add external ON/OFF control function like LDO.

External  $R_{BIAS}$  can adjust power supply to any voltage of 1.71V~3.63V as self bias function. Standard power supply voltages are 3.45V, 3.00V, 2.85V and 1.80V.

### APPLICATIONS

GPS band RF signal amplified

### FEATURES

- Noise Figure : NF=0.96dB (TYP.) (@ 1.575GHz)
- Low Power Consumption : 12.6mW (TYP.) ( $V_{DD}=1.80V$ ,  $R_{BIAS}=92\Omega$ )
- High Gain : S21 =22.0dB (TYP.) (@ 1.575GHz)
- CE Function : CE "H" 1.1V~ $V_{DD}$  ( $1.71V \leq V_{DD} \leq 3.15V$ )  
CE "L" 0V~0.4V
- Operation Voltage Range : 1.71V~3.63V
- Output : CMOS Output  
50Ω Driver Built-in
- Operating Temperature Range : - 40°C~+ 85°C
- Package : USP-8A01
- Environmentally Friendly : EU RoHS Compliant, Pb Free

### TYPICAL APPLICATION CIRCUIT

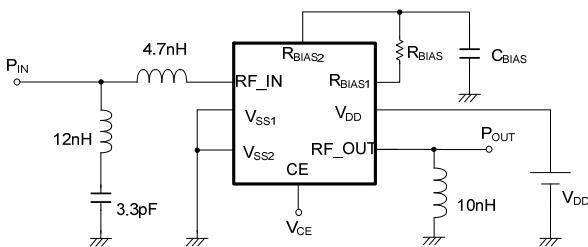

TOP VIEW

$V_{DD}$ [V] (TYP.)	$R_{BIAS}$ [ $\Omega$ ]
3.45	360
3.00	270
2.85	240
1.80	92

\*  $R_{BIAS}$  should be used in  $\pm 1\%$  tolerance and  $\pm 200\text{ppm/}$  temperature stability.

### TYPICAL PERFORMANCE CHARACTERISTICS

Power Gain / Noise Figure vs. Frequency

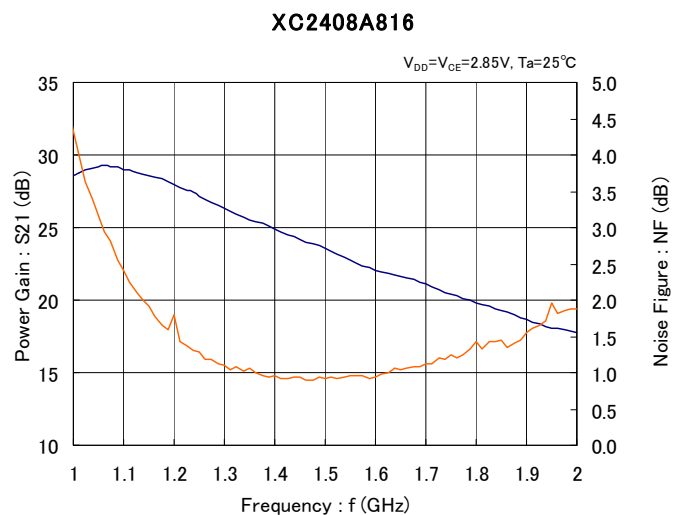



## ■ PIN CONFIGURATION

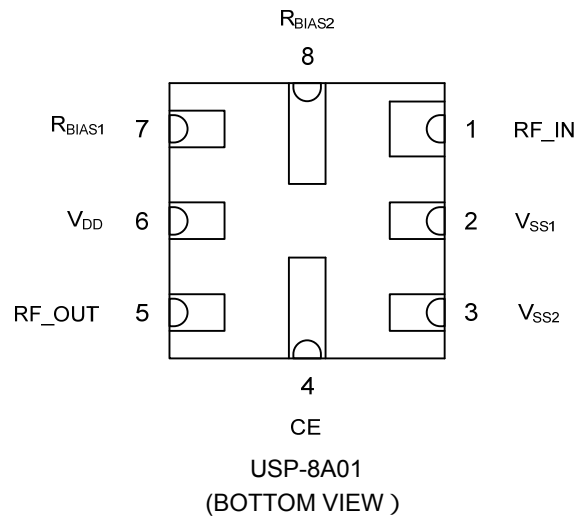

## ■ PIN ASSIGNMENT

PIN NUMBER	PIN NAME	FUNCTION
1	RF_IN	RF Signal Input
2	V <sub>SS1</sub>	Ground
3	V <sub>SS2</sub>	Ground
4	CE	ON/OFF Control Pin
5	RF_OUT	RF Signal Output
6	V <sub>DD</sub>	Power Supply
7	R <sub>BIAS1</sub>	R <sub>BIAS</sub> Connect Pin
8	R <sub>BIAS2</sub>	R <sub>BIAS</sub> Connect Pin

## ■ FUNCTION CHART

PIN NAME	SIGNAL	STATUS
CE	CE High	Active
	CE Low	Stand-by
	CE OPEN	Undefined State

# XC2408A816UR-G

## ABSOLUTE MAXIMUM RATINGS

Ta=25

PARAMETER	SYMBOL	RATINGS	UNITS
Power Supply Voltage	V <sub>DD</sub>	-0.3 ~ 4.0	V
CE Input Voltage	V <sub>CE</sub>	-0.3 ~ V <sub>DD</sub> +0.3 or 4.0 <sup>(*)</sup>	V
Current Circuit	I <sub>DD</sub>	42	mA
R <sub>BIAS1</sub> Input Voltage	R <sub>BIAS1</sub>	-0.3 ~ V <sub>DD</sub> +0.3 or 4.0 <sup>(*)</sup>	V
R <sub>BIAS2</sub> Input Voltage	R <sub>BIAS2</sub>	-0.3 ~ +1.6	V
RF Input Power	P <sub>IN</sub>	10	dBm
RF_IN Input Voltage	V <sub>RF_IN</sub>	-0.3 ~ R <sub>BIAS2</sub> +0.3 or +1.6 <sup>(*)</sup>	V
RF_OUT Input Voltage	V <sub>RF_OUT</sub>	-0.3 ~ R <sub>BIAS2</sub> +0.3 or +1.6 <sup>(*)</sup>	V
Power Dissipation	P <sub>d</sub>	120	mW
Operating Ambient Temperature	Topr	-40 ~ +85	
Storage Temperature	Tstg	-55 ~ +125	

\* All voltages are described based on the V<sub>SS1</sub> and V<sub>SS2</sub> pin.

V<sub>SS1</sub> pin and V<sub>SS2</sub> pin should be connected each other outside.

<sup>(\*)</sup> The maximum value should be either V<sub>DD</sub>+0.3V or +4.0V in the lowest.

<sup>(\*)</sup> The maximum value should be either R<sub>BIAS2</sub>+0.3V or +1.6V in the lowest.

## ELECTRICAL CHARACTERISTICS

DC Characteristics

Ta=25

PARAMETER	SYMBOL	CONDITIONS	MIN.	TYP.	MAX.	UNITS	CIRCUIT
Power Supply Voltage	V <sub>DD</sub>	R <sub>BIAS</sub> =360Ω <sup>(*)</sup>	3.278	3.450	3.630	V	①
		R <sub>BIAS</sub> =270Ω <sup>(*)</sup>	2.850	3.000	3.150	V	①
		R <sub>BIAS</sub> =240Ω <sup>(*)</sup>	2.708	2.850	2.992	V	①
		R <sub>BIAS</sub> =92Ω <sup>(*)</sup>	1.710	1.800	1.890	V	①
Current Circuit	I <sub>DD</sub>	1.71V V <sub>DD</sub> 3.63V <sup>(*)</sup> V <sub>CE</sub> =V <sub>DD</sub>	-	7.0	9.6	mA	①
Stand-by Current	I <sub>STBY</sub>	1.71V V <sub>DD</sub> 3.63V <sup>(*)</sup> V <sub>CE</sub> =0V	-	-	0.1	μA	①
CE "H" Level Voltage	V <sub>CEH</sub>	1.71V V <sub>DD</sub> 3.15V	1.1	-	V <sub>DD</sub>	V	①
		3.15V<V <sub>DD</sub> 3.63V	1.3	-	V <sub>DD</sub>	V	①
CE "L" Level Voltage	V <sub>CEL</sub>	-	0	-	0.4	V	①

(\*) For the relation of V<sub>DD</sub> and R<sub>BIAS</sub>, Please refer to the "Power Supply Voltage vs. R<sub>BIAS</sub> Table" below.

(\*\*) R<sub>BIAS</sub> should be used in ± 1% tolerance and ± 200ppm/ temperature stability.

AC Characteristics

V<sub>DD</sub>=V<sub>CE</sub>=2.85V, R<sub>BIAS</sub>=240Ω, Ta=25

PARAMETER	SYMBOL	CONDITIONS	MIN.	TYP.	MAX.	UNITS	CIRCUIT
Power Gain	S21	f=1.575GHz	16.0	22.0	-	dB	②
Input Return Loss	S11	f=1.575GHz	-	7.0	-	dB	②
Output Return Loss	S22	f=1.575GHz	-	17.0	-	dB	②
Isolation	S12	f=1.575GHz	-	-33.0	-	dB	②
Noise Figure <sup>(*)</sup>	NF	f=1.575GHz	-	0.96	-	dB	③
Input Power IP3	IIP3	f=1.575GHz, 1.576GHz	-	-15.5	-	dBm	④
Input Power IP2	IIP2	f=0.8GHz, 2.345GHz	-	13.2	-	dBm	④
Input Power @ 1dB Gain Compression	P1dB	f=1.575GHz	-	-24.0	-	dBm	②

(\*) NF is the value excluding the substrate loss.

Power Supply Voltage vs. R<sub>BIAS</sub>

V <sub>DD</sub> [V]	R <sub>BIAS</sub> [Ω]
3.278~3.630	360
2.850~3.150	270
2.708~2.992	240
1.710~1.890	92

## NOTE ON USE

1. For temporary, transitional voltage drop or voltage rising phenomenon, the IC is liable to malfunction should the ratings be exceeded.
2. Please eliminate static electricity from the operational table, people, and soldering iron.
3. Please use noiseless power supply for stable operation.
4. Please connect  $C_{BIAS}$  to  $R_{BIAS2}$  pin as close as possible.
5.  $V_{SS1}$  pin and  $V_{SS2}$  pin should be connected each other outside.
6. Please ensure to use an external component which does not depend on bias or temperature too much.
7. Torex places an importance on improving our products and their reliability.  
We request that users incorporate fail-safe designs and post-aging protection treatment when using Torex products in their systems.

## TEST CIRCUITS

Circuit (DC Characteristics: Power Supply Pin Voltage, Circuit Current, Stand-by Current)

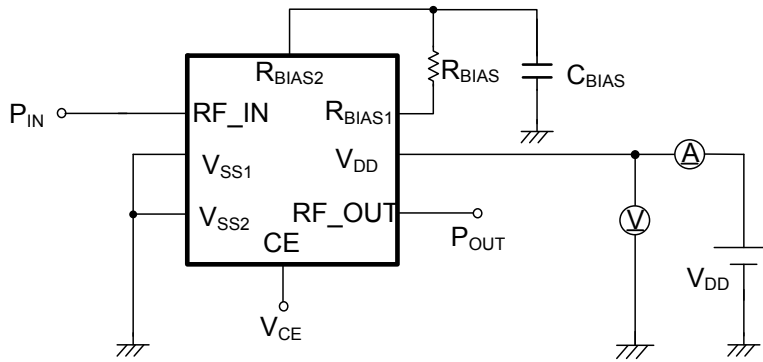

\* $P_{IN} / P_{OUT}$  is  $50\Omega$

Circuit (Power Gain, Input Return Loss, Output Return Loss, Isolation, Input Power @ 1dB Gain Compression)

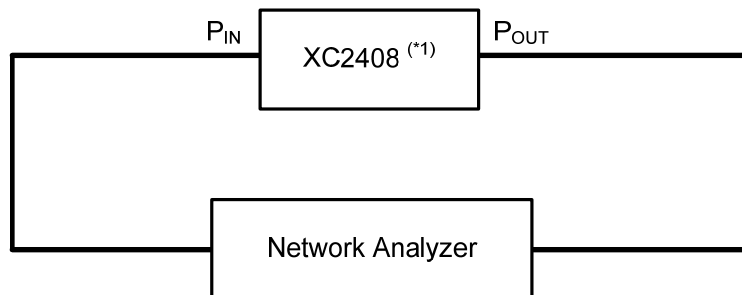

(\*1) Refer to the circuit for the block detail.

Circuit (Noise Figure)

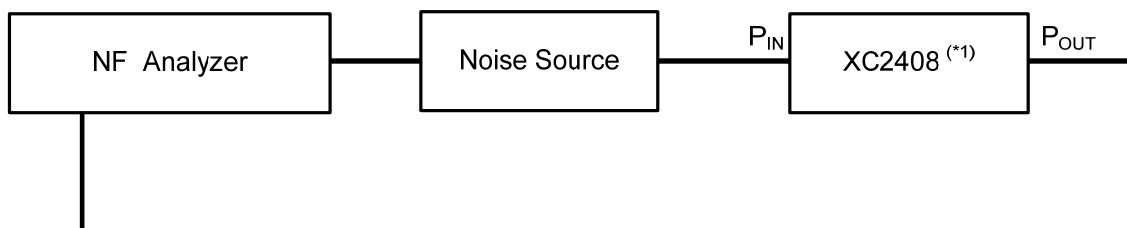

(\*1) Refer to the circuit for the block detail.

# XC2408A816UR-G

## TEST CIRCUITS (Continued)

Circuit (Input Power IP3, Input Power IP2)

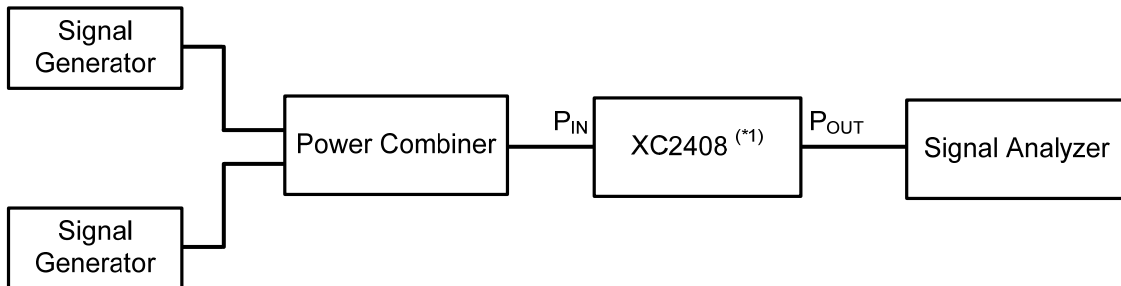

(\*1) Refer to the circuit for the block detail.

Circuit (XC2408 series, the circuit of the block)

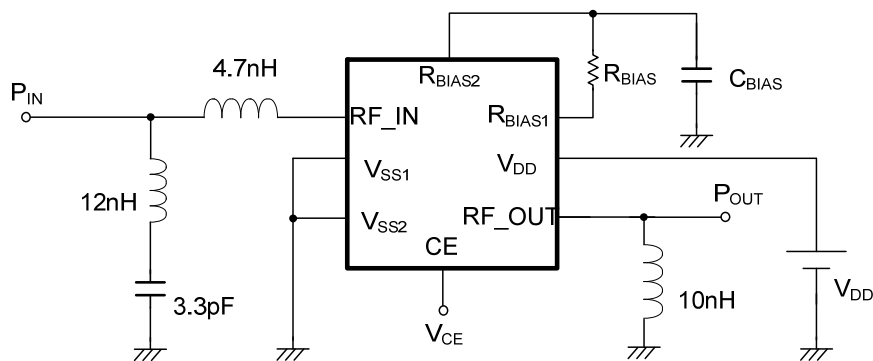

V <sub>DD</sub> [V] (TYP.)	R <sub>BIAS</sub> [Ω]
3.45	360
3.00	270
2.85	240
1.80	92

\* R<sub>BIAS</sub> should be used in ± 1% tolerance and ± 200ppm/ temperature stability.



## ■ TEST CIRCUITS (Continued)

Evaluation Board

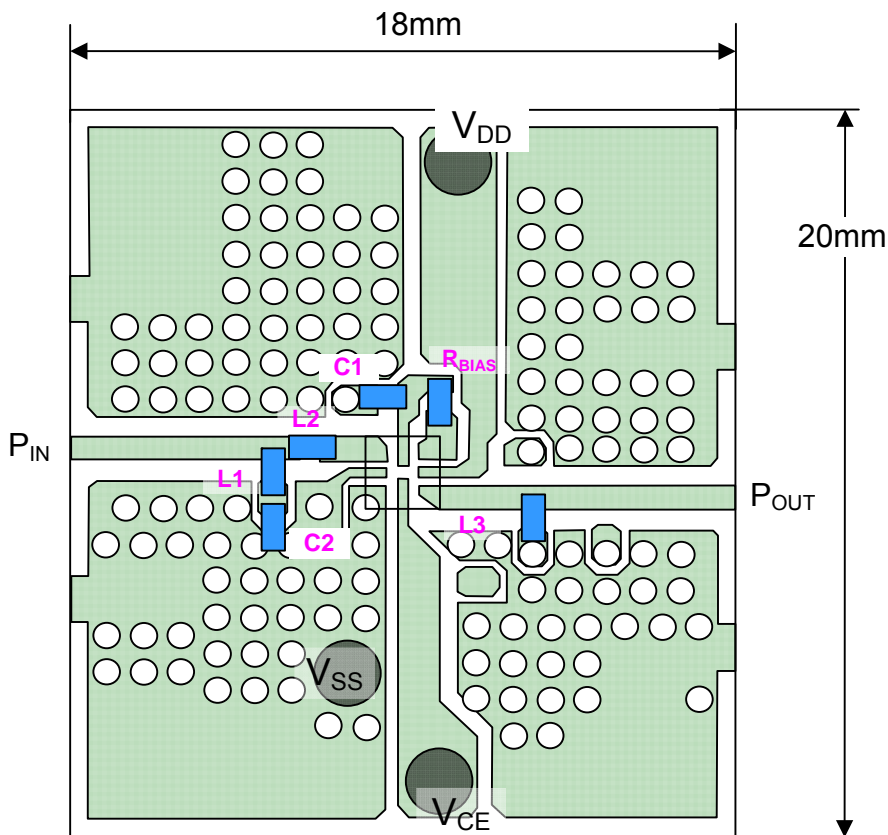

PCB (FR-4)  
 MICROSTRIPLINE WIDTH=0.6mm  
 $t=0.18\text{mm}$   
 PCB size = 18mm × 20mm

\* Please use an external component which does not depend on bias or temperature too much.

### External Components

SYMBOL	SPEC	COMMENT
C1	10nF	-
C2	3.3pF	-
L1	12nH	MURATA (LQW15A12NG00D)
L2	4.7nH	MURATA (LQW15A4N7G00D)
L3	10nH	MURATA (LQW15A10NG00D)
$R_{BIAS}$	-	Less than $\pm 1\%$ tolerance, Less than $\pm 200\text{ppm/}$ temperature stability

# XC2408A816UR-G

## TYPICAL PERFORMANCE CHARACTERISTICS

(1) Current Circuits vs. Supply Voltage

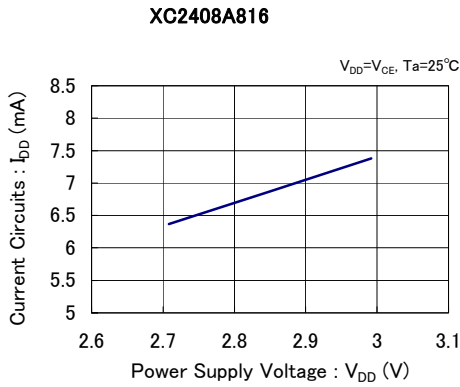

(2) CE "H" Level Voltage vs. Supply Voltage

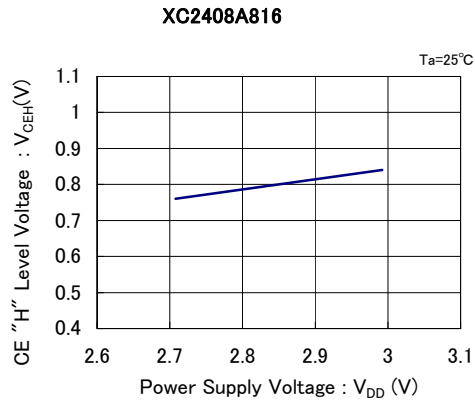

(3) CE "L" Level Voltage vs. Power Supply Voltage

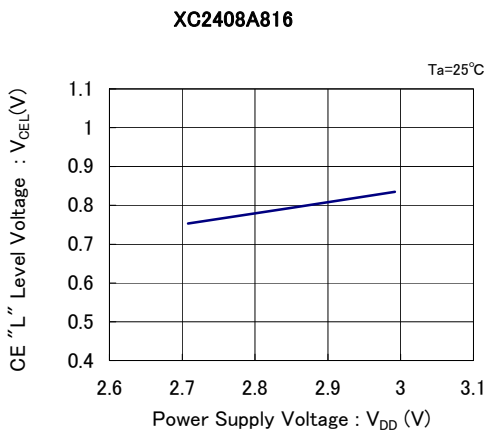

(4) Power Gain vs. Power Supply Voltage

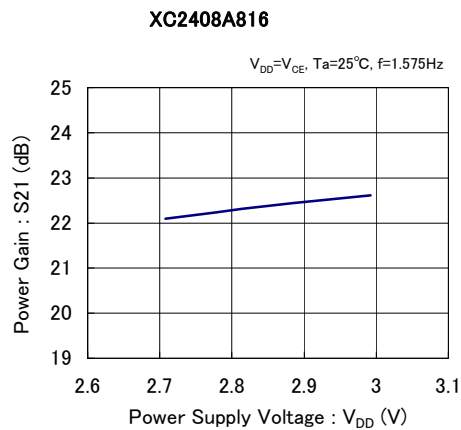

(5) Input Return Loss vs. Power Supply Voltage

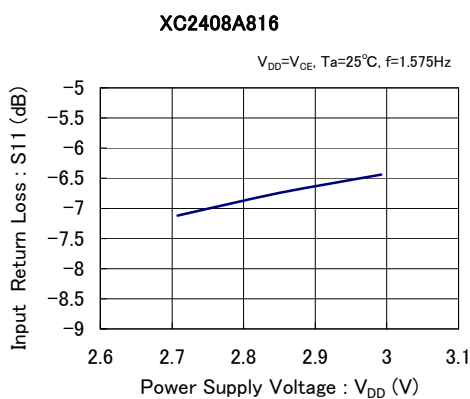

(6) Output Return Loss vs. Supply Voltage

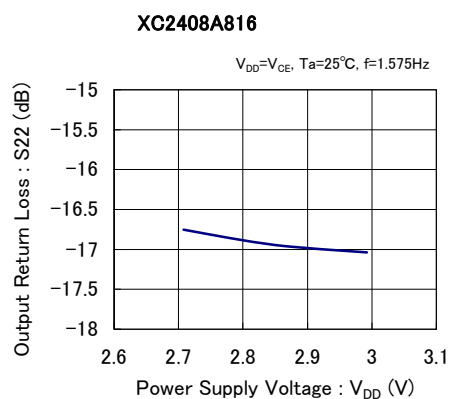

■ TYPICAL PERFORMANCE CHARACTERISTICS (Continued)

(7) Isolation vs. Power Supply Voltage

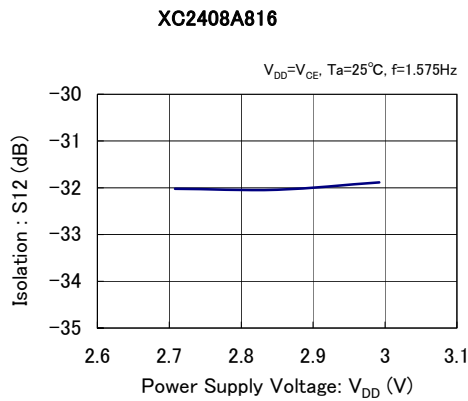

(8) Noise Figure vs. Power Supply Voltage

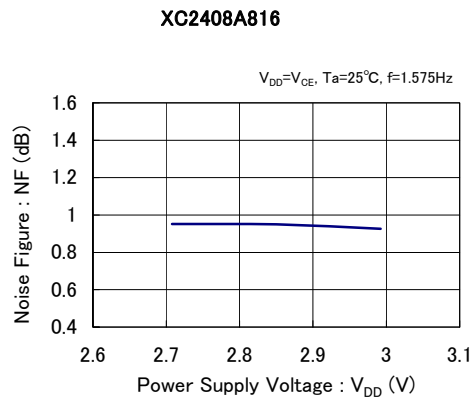

(9) Input Power IP3 vs. Power Supply Voltage

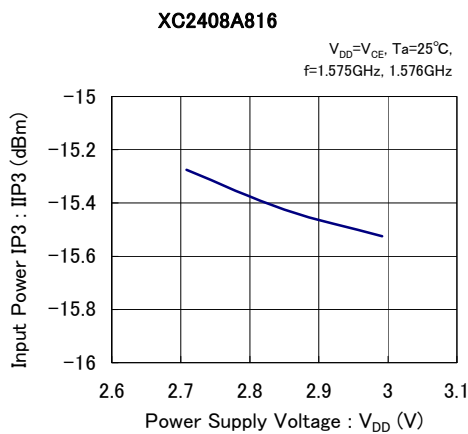

(10) Input Power IP2 vs. Power Supply Voltage

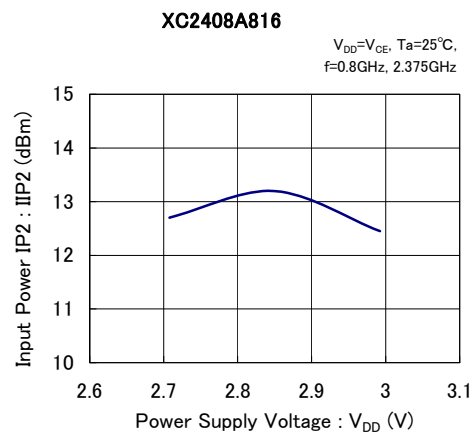

(11) Input Power @ 1dB Gain Compression vs. Power Supply Voltage

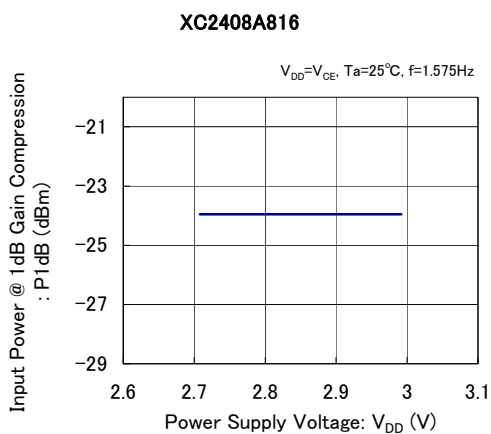

(12) Power Gain vs. Ambient Temperature

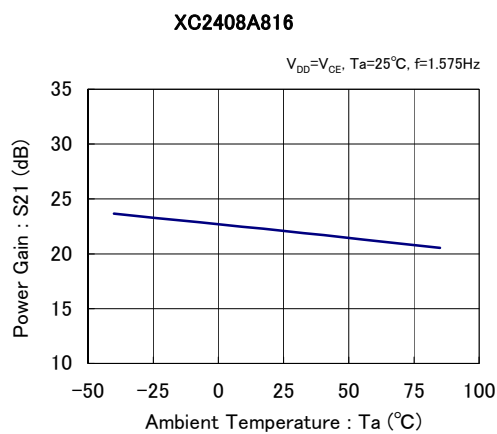

# XC2408A816UR-G

## TYPICAL PERFORMANCE CHARACTERISTICS (Continued)

(13) Input Return Loss vs. Ambient Temperature

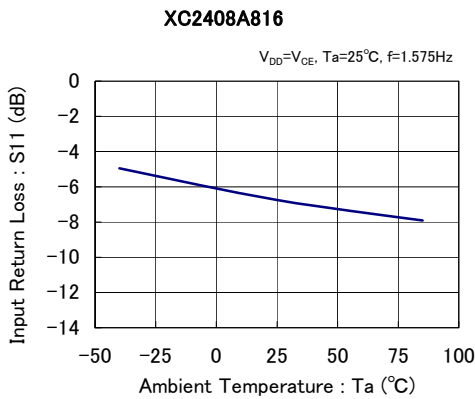

(14) Output Return Loss vs. Ambient Temperature

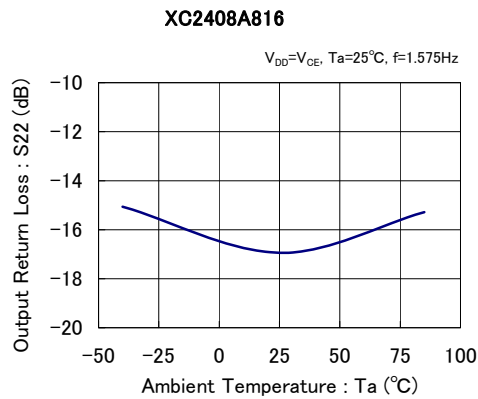

(15) Isolation vs. Ambient Temperature

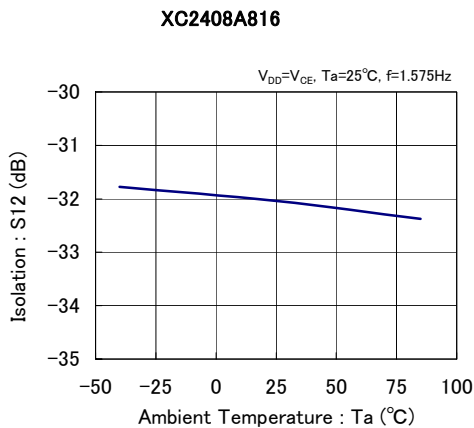

(16) Noise Figure vs. Ambient Temperature

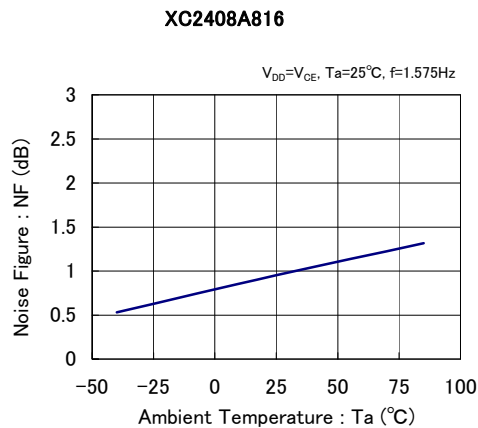

(17) Input Power IP3 vs. Ambient Temperature

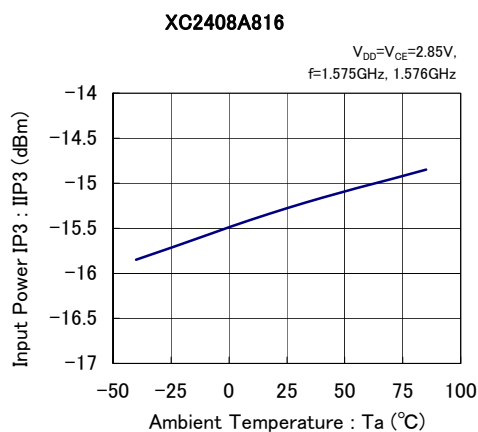

(18) Input Power IP2 vs. Ambient Temperature

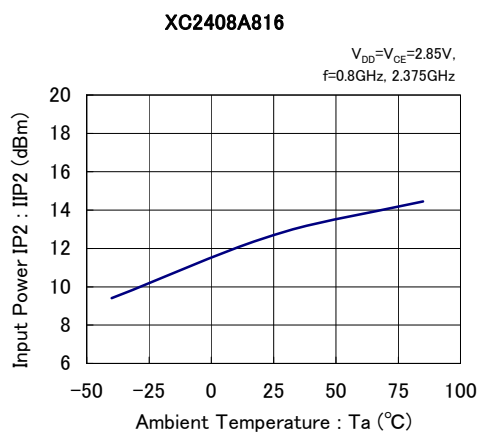

■ TYPICAL PERFORMANCE CHARACTERISTICS (Continued)

(19) Input Power @ 1dB Gain Compression vs. Ambient Temperature

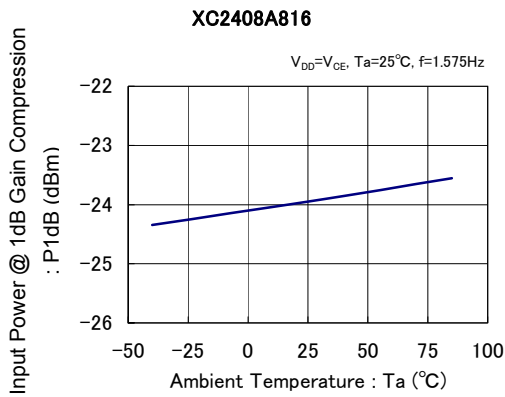

(20) Power Gain vs. Frequency

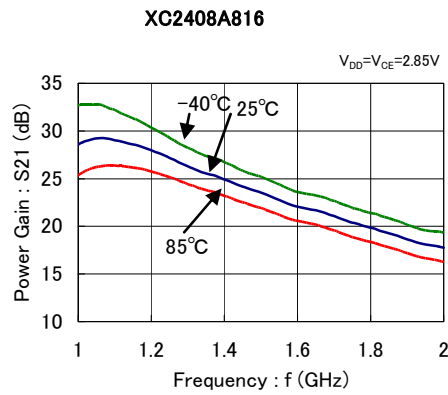

(21) Input Return Loss vs. Frequency

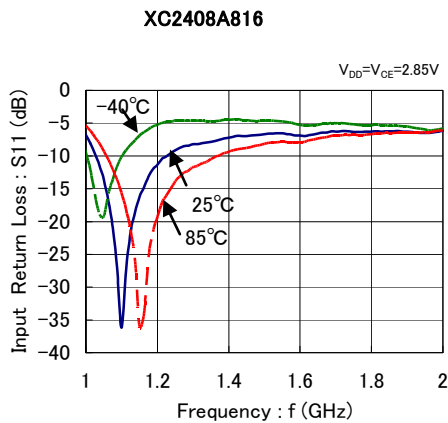

(22) Output Return Loss vs. Frequency

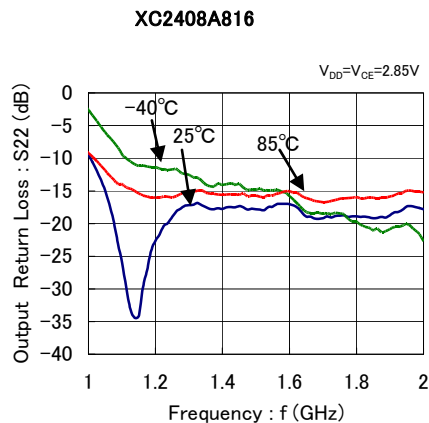

(23) Isolation vs. Frequency

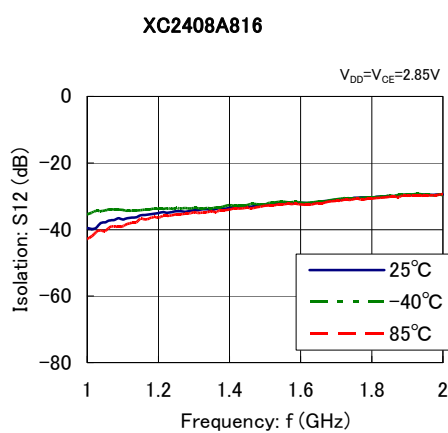

(24) Power Gain vs. Input Power

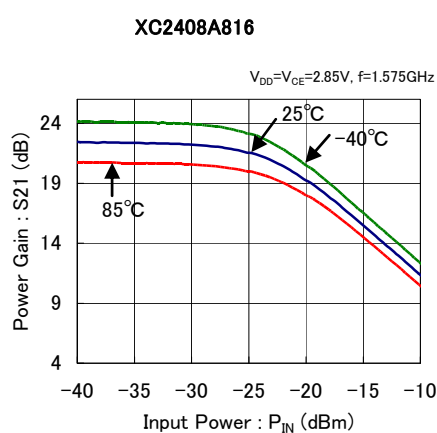

# XC2408A816UR-G

## TYPICAL PERFORMANCE CHARACTERISTICS (Continued)

(25) Output Power / IM3 vs. Input Power

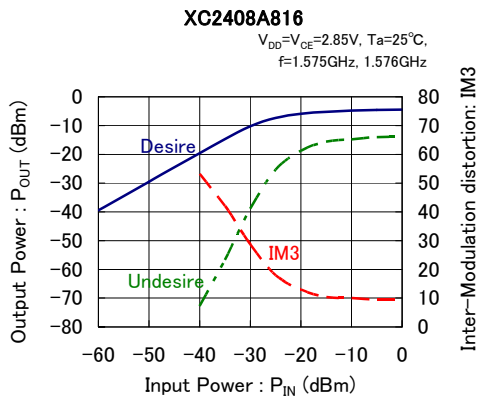

(26) Input Return Loss vs. Frequency (Smith Chart)

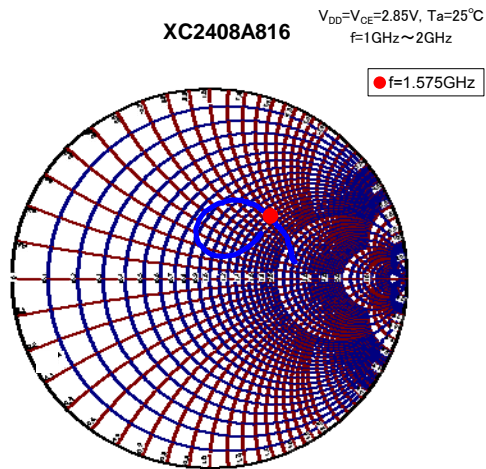

(27) Output Return Loss vs. Frequency (Smith Chart)

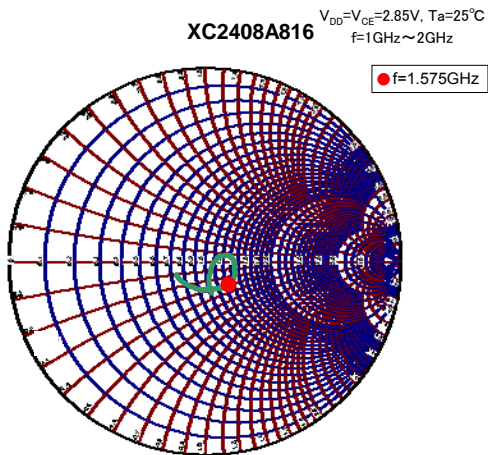

## PACKAGING INFORMATION

USP-8A01 (unit:mm)

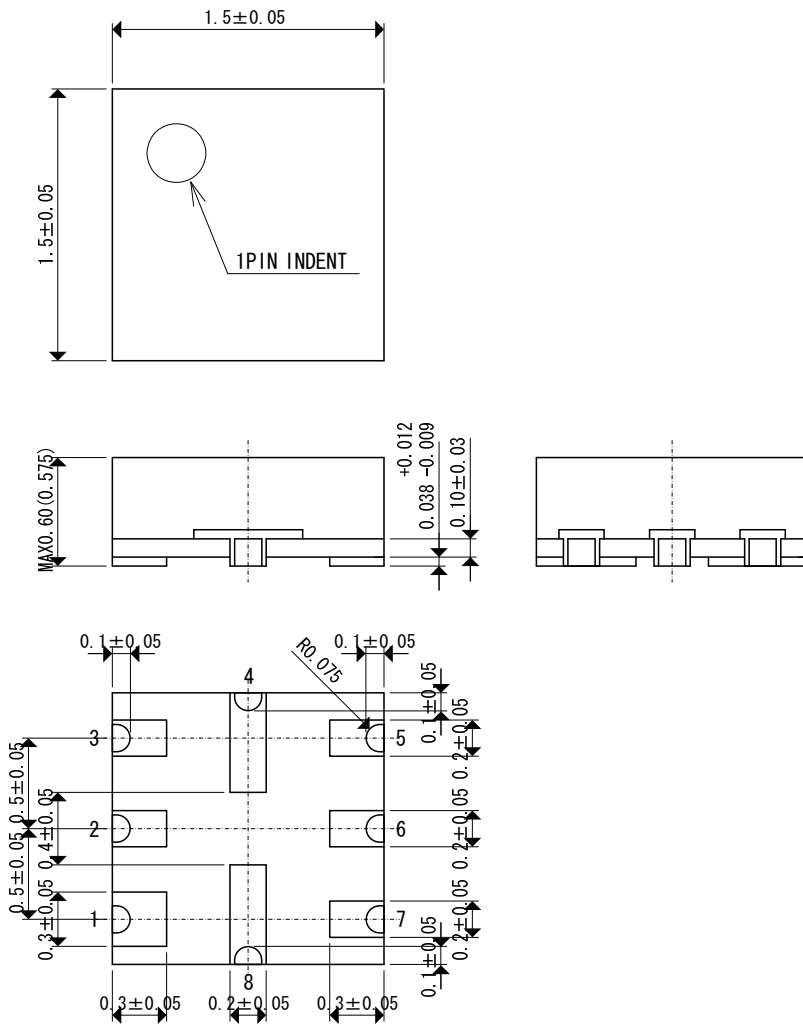

# XC2408A816UR-G

## PACKAGING INFORMATION (Continued)

USP-8A01 Reference Pattern Layout (unit:mm)

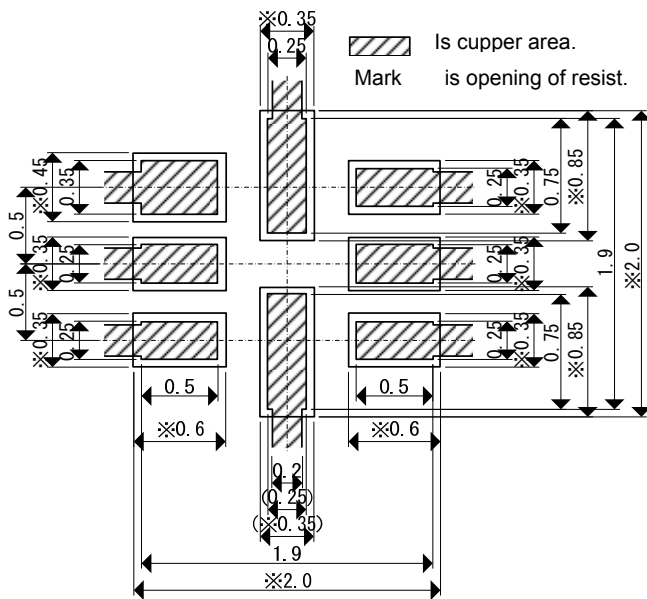

USP-8A01 Reference Metal Mask Design (unit:mm)

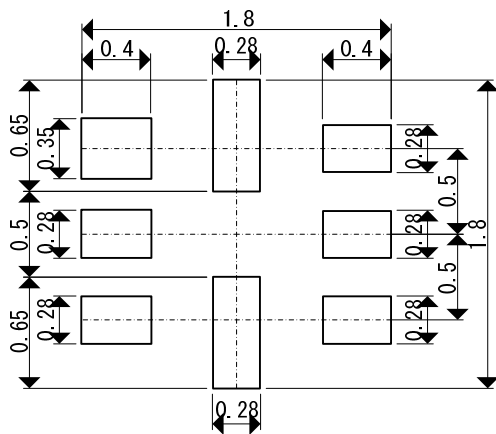



■ MARKING RULE

USP-8A01

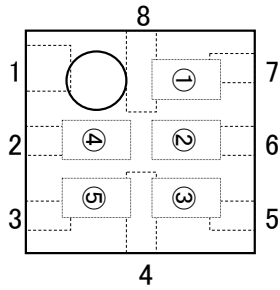

① represents product series.

MARK	PRODUCT SERIES
8	XC2408*****-G

② represents product.

MARK	PRODUCT SERIES
②	
A	XC2408A****-G

③ represents product.

MARK	PRODUCT SERIES
③	
8	XC2408*8****-G

④,⑤ represents production lot number.

01 to 09, 0A to 0Z, 11 to 9Z, A1 to A9, AA to AZ and B1 to ZZ in order.  
(G, I, J, O, Q, W excepted)

\* No character inversion used.

1. The products and product specifications contained herein are subject to change without notice to improve performance characteristics. Consult us, or our representatives before use, to confirm that the information in this datasheet is up to date.
2. We assume no responsibility for any infringement of patents, patent rights, or other rights arising from the use of any information and circuitry in this datasheet.
3. Please ensure suitable shipping controls (including fail-safe designs and aging protection) are in force for equipment employing products listed in this datasheet.
4. The products in this datasheet are not developed, designed, or approved for use with such equipment whose failure or malfunction can be reasonably expected to directly endanger the life of, or cause significant injury to, the user.  
(e.g. Atomic energy; aerospace; transport; combustion and associated safety equipment thereof.)
5. Please use the products listed in this datasheet within the specified ranges.  
Should you wish to use the products under conditions exceeding the specifications, please consult us or our representatives.
6. We assume no responsibility for damage or loss due to abnormal use.
7. All rights reserved. No part of this datasheet may be copied or reproduced without the prior permission of TOREX SEMICONDUCTOR LTD.

**TOREX SEMICONDUCTOR LTD.**