

Panasonic

ideas for life

SIL type SSR with 9mm thickness controls up to 3A

AQ8 RELAYS

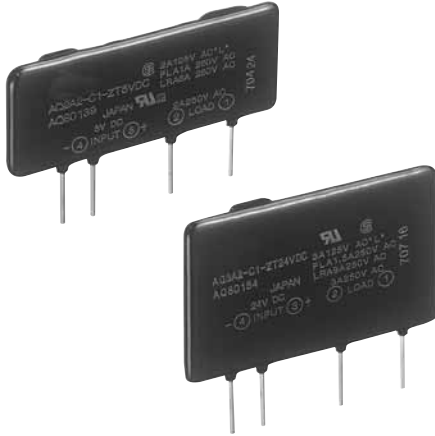

RoHS compliant

FEATURES

- 1. Slim with 9 mm .354 inch thickness**
The thin type (45 mm long × 24 mm high × 9 mm wide) (1.772×.945×.354 inch) permits high density mounting.
- 2. Excellent in noise resistance**
Since the input and output are insulated by the phototriac coupler, the noise on the output side is not fed back to the input side.
- 3. Snubber circuit integrated**
The snubber circuit is integrated to prevent malfunction caused by the rapid rise of the voltage on the output side, such as inductive load and noise.
- 4. Zero-cross and random types are available.**
The zero-cross type generates minimal noise by suppressing occurrence of radio frequency interference (RFI) and electromagnetic interference (EMI).
The random type features a short operation time which permits phase control.

- 5. High dielectric strength: 3,000 V AC (between input and output)**
- 6. Two kinds of terminals distance are available. (5.08 mm and 7.62 mm) (.200 inch and .300 inch)**
- 7. High reliability, long life and maintenance-free**

TYPICAL APPLICATIONS

- 1. Most suitable as drivers for small size AC motors, solenoids, solenoid valves and so on.**
- 2. Copying equipment**
- 3. Air conditioners**
- 4. Industrial equipment such as NC machines, sequencers, robots, etc.**

ORDERING INFORMATION

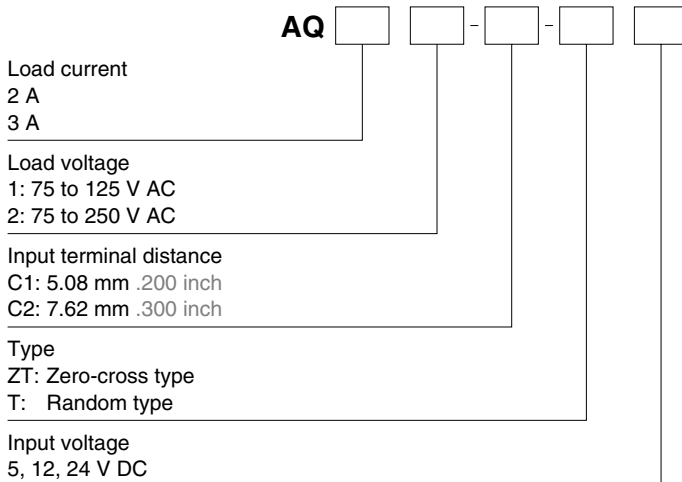

TYPES

Types	Load current	Load voltage	Input voltage	Input terminals distance (5.08 mm .200 inch type)	Input terminals distance (7.62 mm .300 inch type)
				Part No.	Part No.
Zero-cross type	2A	75 to 125V AC	5 V DC	AQ2A1-C1-ZT5V DC	AQ2A1-C2-ZT5V DC
			12 V DC	AQ2A1-C1-ZT12V DC	AQ2A1-C2-ZT12V DC
			24 V DC	AQ2A1-C1-ZT24V DC	AQ2A1-C2-ZT24V DC
		75 to 250V AC	5 V DC	AQ2A2-C1-ZT5V DC	AQ2A2-C2-ZT5V DC
			12 V DC	AQ2A2-C1-ZT12V DC	AQ2A2-C2-ZT12V DC
			24 V DC	AQ2A2-C1-ZT24V DC	AQ2A2-C2-ZT24V DC
	3A	75 to 125V AC	5 V DC	AQ3A1-C1-ZT5V DC	AQ3A1-C2-ZT5V DC
			12 V DC	AQ3A1-C1-ZT12V DC	AQ3A1-C2-ZT12V DC
			24 V DC	AQ3A1-C1-ZT24V DC	AQ3A1-C2-ZT24V DC
		75 to 250V AC	5 V DC	AQ3A2-C1-ZT5V DC	AQ3A2-C2-ZT5V DC
			12 V DC	AQ3A2-C1-ZT12V DC	AQ3A2-C2-ZT12V DC
			24 V DC	AQ3A2-C1-ZT24V DC	AQ3A2-C2-ZT24V DC
Random type	2A	75 to 125V AC	5 V DC	AQ2A1-C1-T5V DC	AQ2A1-C2-T5V DC
			12 V DC	AQ2A1-C1-T12V DC	AQ2A1-C2-T12V DC
			24 V DC	AQ2A1-C1-T24V DC	AQ2A1-C2-T24V DC
		75 to 250V AC	5 V DC	AQ2A2-C1-T5V DC	AQ2A2-C2-T5V DC
			12 V DC	AQ2A2-C1-T12V DC	AQ2A2-C2-T12V DC
			24 V DC	AQ2A2-C1-T24V DC	AQ2A2-C2-T24V DC
	3A	75 to 125V AC	5 V DC	AQ3A1-C1-T5V DC	AQ3A1-C2-T5V DC
			12 V DC	AQ3A1-C1-T12V DC	AQ3A1-C2-T12V DC
			24 V DC	AQ3A1-C1-T24V DC	AQ3A1-C2-T24V DC
		75 to 250V AC	5 V DC	AQ3A2-C1-T5V DC	AQ3A2-C2-T5V DC
			12 V DC	AQ3A2-C1-T12V DC	AQ3A2-C2-T12V DC
			24 V DC	AQ3A2-C1-T24V DC	AQ3A2-C2-T24V DC

Standard packing: Carton 20 pcs., Case 200 pcs.

RATING

1. Rating (Ambient temperature: 20°C, 68°F; Voltage ripple on the input side: 1% or less)

1) Zero-cross type

• 2 A type

Item	Part No.	AQ2A1-C1-ZT5VDC AQ2A1-C2-ZT5VDC	AQ2A1-C1-ZT12VDC AQ2A1-C2-ZT12VDC	AQ2A1-C1-ZT24VDC AQ2A1-C2-ZT24VDC	AQ2A2-C1-ZT5VDC AQ2A2-C2-ZT5VDC	AQ2A2-C1-ZT12VDC AQ2A2-C2-ZT12VDC	AQ2A2-C1-ZT24VDC AQ2A2-C2-ZT24VDC	Remarks
Input side	Control voltage	5 V DC (4 to 6V)	12 V DC (9.6 to 14.4V)	24 V DC (21.6 to 26.4V)	5 V DC (4 to 6V)	12 V DC (9.6 to 14.4V)	24 V DC (21.6 to 26.4V)	*1
	Input impedance	Approx. 0.18 kΩ	Approx. 0.55 kΩ	Approx. 1.4 kΩ	Approx. 0.18 kΩ	Approx. 0.55 kΩ	Approx. 1.4 kΩ	
	Drop-out voltage	Min. 0.5 V	Min. 1.2 V	Min. 2.4 V	Min. 0.5 V	Min. 1.2 V	Min. 2.4 V	
Load side	Max. load current	2 A*2						At ambient temperature of 30°C or less
	Load voltage	75 to 125 V AC			75 to 250 V AC			
	Frequency	45 to 65 Hz						
	Repetitive peak OFF voltage	400 V			600 V			
	Non-repetitive surge current	30 A*3						In one cycle at 60 Hz
	Max. "OFF-state" leakage current	2.5 mA (100 V applied)			5 mA (200 V applied)			at 60 Hz
	Max. "ON-state" voltage drop	1.6 V						at max. carrying current
	Min. load current	25 mA*4			50 mA*4			
OFF state dV/dt	50 V/μs						At ambient temperature of 80°C	

• 3 A type

Item	Part No.	AQ3A1-C1-ZT5VDC AQ3A1-C2-ZT5VDC	AQ3A1-C1-ZT12VDC AQ3A1-C2-ZT12VDC	AQ3A1-C1-ZT24VDC AQ3A1-C2-ZT24VDC	AQ3A2-C1-ZT5VDC AQ3A2-C2-ZT5VDC	AQ3A2-C1-ZT12VDC AQ3A2-C2-ZT12VDC	AQ3A2-C1-ZT24VDC AQ3A2-C2-ZT24VDC	Remarks
Input side	Control voltage	5 V DC (4 to 6V)	12 V DC (9.6 to 14.4V)	24 V DC (21.6 to 26.4V)	5 V DC (4 to 6V)	12 V DC (9.6 to 14.4V)	24 V DC (21.6 to 26.4V)	*1
	Input impedance	Approx. 0.18 kΩ	Approx. 0.55 kΩ	Approx. 1.4 kΩ	Approx. 0.18 kΩ	Approx. 0.55 kΩ	Approx. 1.4 kΩ	
	Drop-out voltage	Min. 0.5 V	Min. 1.2 V	Min. 2.4 V	Min. 0.5 V	Min. 1.2 V	Min. 2.4 V	
Load side	Max. load current	3 A*2						At ambient temperature of 30°C or less
	Load voltage	75 to 125 V AC			75 to 250 V AC			
	Frequency	45 to 65 Hz						
	Repetitive peak OFF voltage	400 V			600 V			
	Non-repetitive surge current	80 A*3						In one cycle at 60 Hz
	Max. "OFF-state" leakage current	2.5 mA (100 V applied)			5 mA (200 V applied)			at 60 Hz
	Max. "ON-state" voltage drop	1.6 V						at max. carrying current
	Min. load current	25 mA*4			50 mA*4			
	OFF state dV/dt	50 V/μs						At ambient temperature of 80°C

Notes: *1. Refer to REFERENCE DATA "3. Characteristics of input current vs. input voltage".
 *2. Refer to REFERENCE DATA "1. Characteristics of load current vs. ambient temperature".
 *3. Refer to REFERENCE DATA "2. Characteristics of non-repetitive surge current vs. carrying time".
 *4. When the load current is less than the rated minimum load current, please refer to "Cautions for Use of SSR".

2) Random type

• 2 A type

Item	Part No.	AQ2A1-C1-T5VDC AQ2A1-C2-T5VDC	AQ2A1-C1-T12VDC AQ2A1-C2-T12VDC	AQ2A1-C1-T24VDC AQ2A1-C2-T24VDC	AQ2A2-C1-T5VDC AQ2A2-C2-T5VDC	AQ2A2-C1-T12VDC AQ2A2-C2-T12VDC	AQ2A2-C1-T24VDC AQ2A2-C2-T24VDC	Remarks
Input side	Control voltage	5 V DC (4 to 6V)	12 V DC (9.6 to 14.4V)	24 V DC (21.6 to 26.4V)	5 V DC (4 to 6V)	12 V DC (9.6 to 14.4V)	24 V DC (21.6 to 26.4V)	*1
	Input impedance	Approx. 0.3 kΩ	Approx. 0.8 kΩ	Approx. 1.8 kΩ	Approx. 0.3 kΩ	Approx. 0.8 kΩ	Approx. 1.8 kΩ	
	Drop-out voltage	Min. 0.5 V	Min. 1.2 V	Min. 2.4 V	Min. 0.5 V	Min. 1.2 V	Min. 2.4 V	
Load side	Max. load current	2 A*2						At ambient temperature of 30°C or less
	Load voltage	75 to 125 V AC			75 to 250 V AC			
	Frequency	45 to 65 Hz						
	Repetitive peak OFF voltage	400 V			600 V			
	Non-repetitive surge current	30 A*3						In one cycle at 60 Hz
	Max. "OFF-state" leakage current	2.5 mA (100 V applied)			5 mA (200 V applied)			at 60 Hz
	Max. "ON-state" voltage drop	1.6 V						at max. carrying current
	Min. load current	25 mA*4			50 mA*4			
	OFF state dV/dt	50 V/μs						At ambient temperature of 80°C

AQ8

• 3 A type

Item	Part No.	AQ3A1-C1-T5VDC AQ3A1-C2-T5VDC	AQ3A1-C1-T12VDC AQ3A1-C2-T12VDC	AQ3A1-C1-T24VDC AQ3A1-C2-T24VDC	AQ3A2-C1-T5VDC AQ3A2-C2-T5VDC	AQ3A2-C1-T12VDC AQ3A2-C2-T12VDC	AQ3A2-C1-T24VDC AQ3A2-C2-T24VDC	Remarks	
Input side	Control voltage	5 V DC (4 to 6V)	12 V DC (9.6 to 14.4V)	24 V DC (21.6 to 26.4V)	5 V DC (4 to 6V)	12 V DC (9.6 to 14.4V)	24 V DC (21.6 to 26.4V)	*1	
	Input impedance	Approx. 0.3 kΩ	Approx. 0.8 kΩ	Approx. 1.8 kΩ	Approx. 0.3 kΩ	Approx. 0.8 kΩ	Approx. 1.8 kΩ		
	Drop-out voltage	Min. 0.5 V	Min. 1.2 V	Min. 2.4 V	Min. 0.5 V	Min. 1.2 V	Min. 2.4 V		
Load side	Max. load current	3 A*2						At ambient temperature of 30°C or less	
	Load voltage	75 to 125 V AC			75 to 250 V AC				
	Frequency	45 to 65 Hz							
	Repetitive peak OFF voltage	400 V			600 V				
	Non-repetitive surge current	80 A*3							In one cycle at 60 Hz
	Max. "OFF-state" leakage current	2.5 mA (100 V applied)			5 mA (200 V applied)				at 60 Hz
	Max. "ON-state" voltage drop	1.6 V							at max. carrying current
	Min. load current	25 mA*4			50 mA*4				
	OFF state dV/dt	50 V/μs							At ambient temperature of 80°C

Notes: *1. Refer to REFERENCE DATA "3. Characteristics of input current vs. input voltage".
 *2. Refer to REFERENCE DATA "1. Characteristics of load current vs. ambient temperature".
 *3. Refer to REFERENCE DATA "2. characteristics of non-repetitive surge current vs. carrying time".
 *4. When the load current is less than the rated minimum load current, please refer to "Cautions for Use of SSR".

2. Characteristics (Ambient temperature: 20°C 68°F; Input voltage ripple: 1% or less)

Item	Type	Zero-cross type	Random type	Remarks
Operate time, max.		1/2 cycle of voltage sine wave + 1 ms	1 ms	
Release time, max.		1/2 cycle of voltage sine wave + 1 ms		
Insulation resistance, min.		10 ⁹ Ω between input and output		at 500 V DC
Breakdown voltage		3,000 V AC between input and output		For 1 minute
Vibration resistance	Destructive	10 to 55 Hz at double amplitude of 3 mm		1 hour for X, Y, Z axis
	Functional	10 to 55 Hz at double amplitude of 3 mm		10 min. for X, Y, Z axis
Shock resistance	Destructive	Min. 980 m/s ² {100 G}		5 times each for X, Y, Z axis
	Functional	Min. 980 m/s ² {100 G}		4 times each for X, Y, Z axis
Ambient temperature		-30°C to +80°C -22°F to +176°F		
Storage temperature		-30°C to +100°C -22°F to +212°F		
Operational method		Zero-cross (Turn ON and Turn OFF)	Random turn ON, zero-cross turn OFF	

REFERENCE DATA

1. Characteristics of load current vs. ambient temperature
 Use load current within range specified in the figure below.

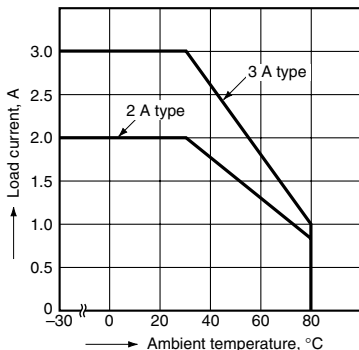

2.-(1) Characteristics of non-repetitive surge current vs. carrying time (2 A type)

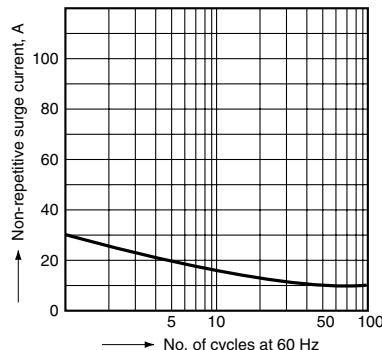

2.-(2) Characteristics of non-repetitive surge current vs. carrying time (3 A type)

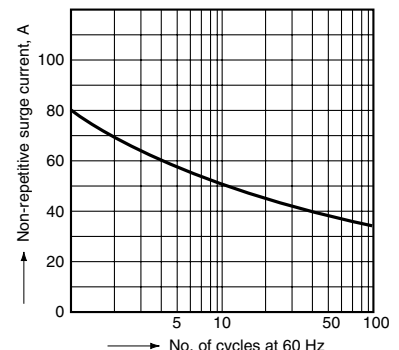

3. Characteristics of input current vs. input voltage

—zero-cross type
 ---Random type

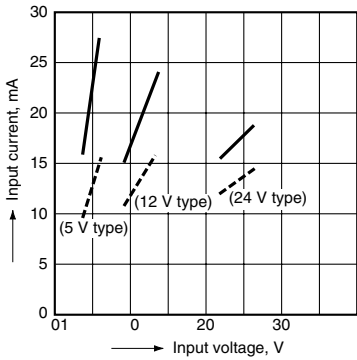

4.-(1) Characteristics of load current vs. ambient temperature for adjacent mounting (2 A type)

Conditions: Natural cooling

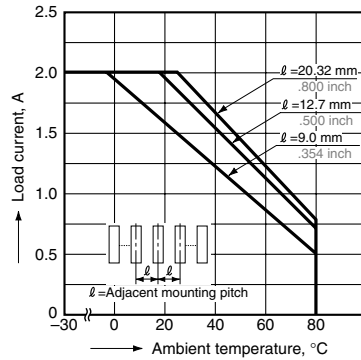

4.-(2) Characteristics of load current vs. ambient temperature for adjacent mounting (3 A type)

Conditions: Natural cooling

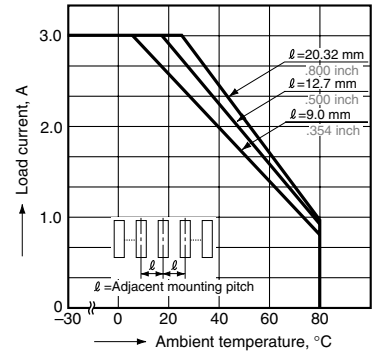

DIMENSIONS (mm inch)

The CAD data of the products with a **CAD Data** mark can be downloaded from: <http://industrial.panasonic.com/ac/e/>

(Common for zero-cross and random types)

1. Input terminals distance 5.08 mm .200 inch

1) 2 A type

CAD Data

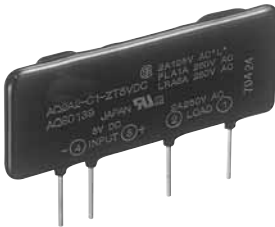

External dimensions

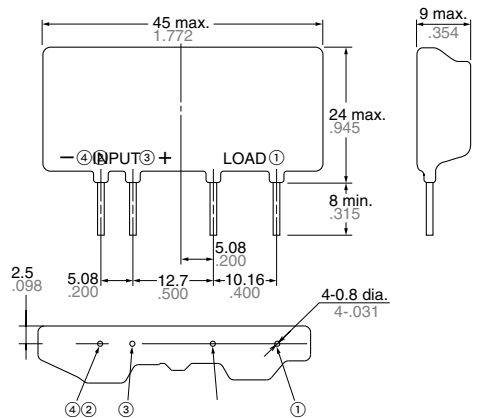

General tolerance: $\pm 0.5 \pm .020$

Mounting hole location (Bottom view)

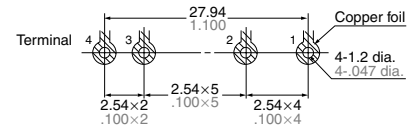

Tolerance: $\pm 0.1 \pm .004$

Schematic

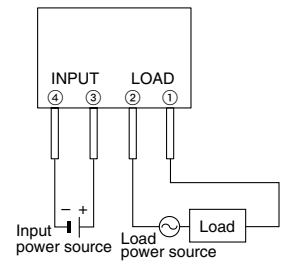

2) 3 A type

CAD Data



External dimensions

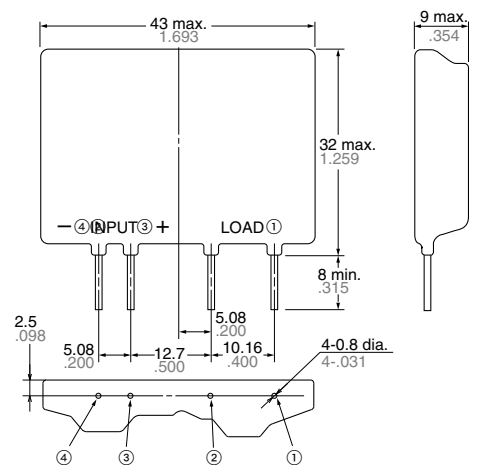

General tolerance: $\pm 0.5 \pm .020$

Mounting hole location (Bottom view)

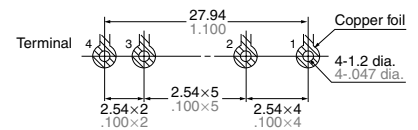

Tolerance: $\pm 0.1 \pm .004$

Schematic

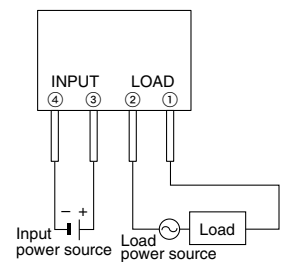

AQ8

2. Input terminals distance 7.62 mm .300 inch

1) 2A type

CAD Data

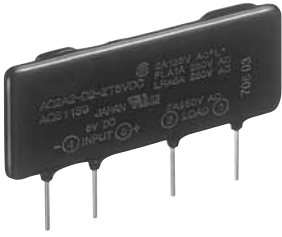

External dimensions

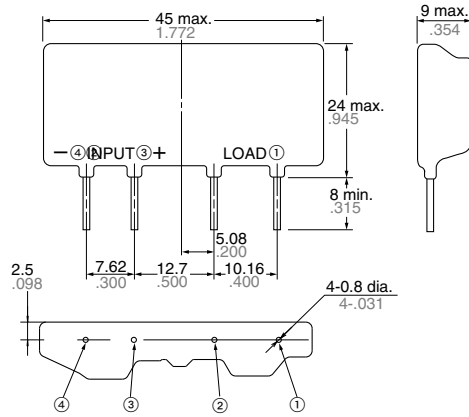

General tolerance: $\pm 0.5 \pm .020$

Mounting hole location (Bottom view)

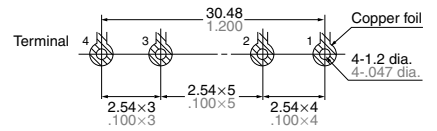

Tolerance: $\pm 0.1 \pm .004$

Schematic

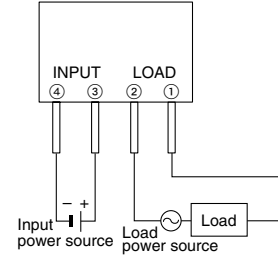

2) 3A type

CAD Data



External dimensions

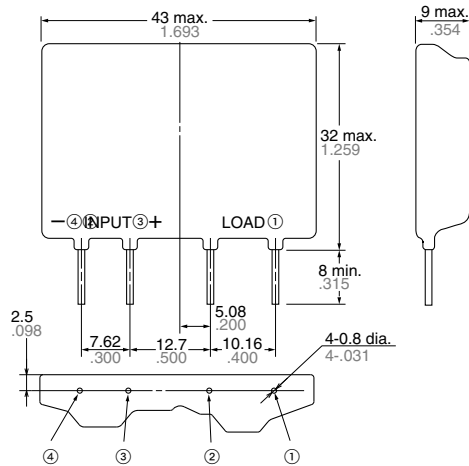

General tolerance: $\pm 0.5 \pm .020$

Mounting hole location (Bottom view)

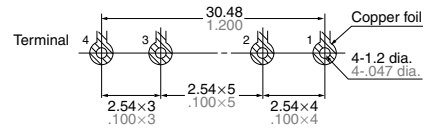

Tolerance: $\pm 0.1 \pm .004$

Schematic

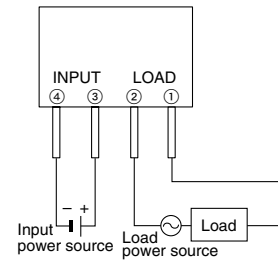

NOTE

1. When used for the load less than rated

In case of the load current less than rated, malfunction may result from the residual voltage across the both ends of the load even if the solid state relay is turned off. Use a dummy resistor as a countermeasure.

The total of the current through the resistor and the load current must exceed the min. rated load current.

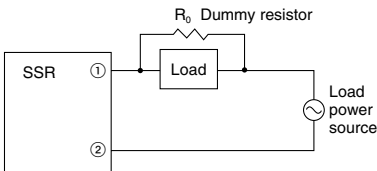

In case the dummy resistor is not used, keep in mind that the residual voltage becomes as follows:

Example:

For the inductive load by the 20 mA load current and the 200 V AC load voltage, the load impedance becomes 10 kΩ and $V_e/V = 14\%$ is estimated from the right above graph. Accordingly, the 28 V voltage remains across the both ends of the load when the solid state relay is turned off.

• Characteristics of residual voltage vs. load impedance

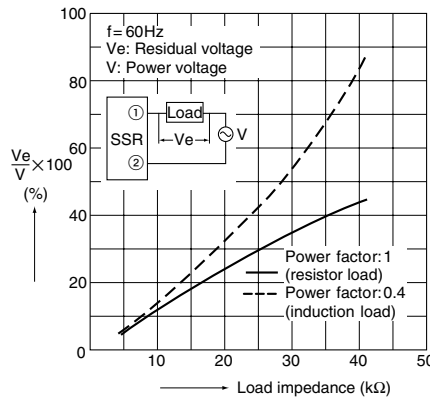

2. when the terminal is bent

Care shall be taken neither to apply mechanical stresses to the mold area of the solid state relay nor to bend the terminal 45 degrees or more.

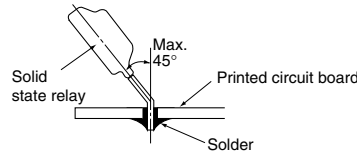

Recommended Temperature Controllers



<KT4H Temperature Controller>

Our temperature controller is recommended for use with our Solid State Relays.

Features

- Space saving requiring only a depth of 65 mm
- Data collection possible through a PLC using RS485 communication
- Tool port is standard for easy data setting
- Inverted LCD + backlight for good legibility with large characters
- Excellent operability and rich optional control functions

Substitute part numbers

Power supply	Control output	Part No.
100 to 240 V AC	Non-contact voltage output	AKT4H112100

*F or detailed product information about temperature controllers, please refer to our website: <http://industrial.panasonic.com/ac/e/>

For Cautions for Use.