



SILICON POWER MOS FET

NE5531079A

7.5 V OPERATION SILICON RF POWER LDMOS FET FOR UHF-BAND 10 W TRANSMISSION AMPLIFIERS

DESCRIPTION

The NE5531079A is an N-channel silicon power laterally diffused MOS FET specially designed as the transmission power amplifier for 7.5 V radio systems. Die are manufactured using our NEWMOS-M1 technology and housed in a surface mount package. This device can deliver 40.0 dBm output power with 68% power added efficiency at 460 MHz with 7.5 V supply voltage.

FEATURES

- High output power : $P_{out} = 40.0$ dBm TYP. ($V_{DS} = 7.5$ V, $I_{Dset} = 200$ mA, $f = 460$ MHz, $P_{in} = 25$ dBm)
- High power added efficiency : $\eta_{add} = 68\%$ TYP. ($V_{DS} = 7.5$ V, $I_{Dset} = 200$ mA, $f = 460$ MHz, $P_{in} = 25$ dBm)
- High linear gain : $G_L = 20.5$ dB TYP. ($V_{DS} = 7.5$ V, $I_{Dset} = 200$ mA, $f = 460$ MHz, $P_{in} = 10$ dBm)
- Surface mount package : $5.7 \times 5.7 \times 1.1$ mm MAX.
- Single supply : $V_{DS} = 7.5$ V MAX.

APPLICATIONS

- 460 MHz band radio systems
- 900 MHz band radio systems

ORDERING INFORMATION

Part Number	Order Number	Package	Marking	Supplying Form
NE5531079A	NE5531079A-A	79A (Pb-Free)	W5	• 12 mm wide embossed taping • Gate pin face the perforation side of the tape
NE5531079A-T1	NE5531079A-T1-A			• 12 mm wide embossed taping • Gate pin face the perforation side of the tape • Qty 1 kpcs/reel
NE5531079A-T1A	NE5531079A-T1A-A			• 12 mm wide embossed taping • Gate pin face the perforation side of the tape • Qty 5 kpcs/reel

Remark To order evaluation samples, please contact your nearby sales office.

Part number for sample order: NE5531079A-A

Caution: Observe precautions when handling because these devices are sensitive to electrostatic discharge

The information in this document is subject to change without notice. Before using this document, please confirm that this is the latest version.

ABSOLUTE MAXIMUM RATINGS (T_A = +25°C)

Operation in excess of any one of these parameters may result in permanent damage.

Parameter	Symbol	Ratings	Unit
Drain to Source Voltage	V _{DS} ^{Note 1}	30	V
Gate to Source Voltage	V _{GS}	6.0	V
Drain Current	I _{DS}	3.0	A
Drain Current (Pulse Test)	I _{DS} ^{Note 2}	6.0	A
Total Power Dissipation	P _{tot}	35	W
Channel Temperature	T _{ch}	125	°C
Storage Temperature	T _{stg}	-55 to +125	°C

Note 1. V_{DS} will be used under 12 V on RF operation.

2. Duty Cycle ≤ 50%, T_{on} ≤ 1 s

RECOMMENDED OPERATING CONDITIONS

Parameter	Symbol	Test Conditions	MIN.	TYP.	MAX.	Unit
Drain to Source Voltage	V _{DS}		-	6.0	7.5	V
Gate to Source Voltage	V _{GS}		1.15	1.55	2.05	V
Drain Current	I _{DS}		-	2.0	-	A
Input Power	P _{in}	f = 460 MHz, V _{DS} = 6.0 V	-	25	30	dBm

ELECTRICAL CHARACTERISTICS

(T_A = +25°C, unless otherwise specified, using our standard test fixture)

Parameter	Symbol	Test Conditions	MIN.	TYP.	MAX.	Unit
Gate to Source Leakage Current	I _{gss}	V _{GS} = 6.0 V	-	-	100	nA
Drain to Source Leakage Current (Zero Gate Voltage Drain Current)	I _{dss}	V _{DS} = 25 V	-	-	10	nA
Gate Threshold Voltage	V _{th}	V _{DS} = 7.5 V, I _{DS} = 1.0 mA	0.8	1.15	1.55	V
Thermal Resistance	R _{th}	Channel to Case	-	2.9	-	°C/W
Transconductance	g _m	V _{DS} = 7.5 V, I _{DS} = 700±100 mA	2.5	3.2	4.0	S
Drain to Source Breakdown Voltage	BV _{DSS}	I _{DSS} = 10 μA	25	35	-	V
Output Power	P _{out}	f = 460 MHz, V _{DS} = 7.5 V,	39.0	40.0	-	dBm
Drain Current	I _{DS}	P _{in} = 25 dBm,	-	2.0	-	A
Power Added Efficiency	η _{add}	I _{Dset} = 200 mA (RF OFF)	-	68	-	%
Linear Gain	G _L ^{Note}		-	20.5	-	dB

Note P_{in} = 10 dBm

DC performance is 100% testing. RF performance is testing several samples per wafer.

Wafer rejection criteria for standard devices is 1 reject for several samples.

TEST CIRCUIT (f = 460 MHz)

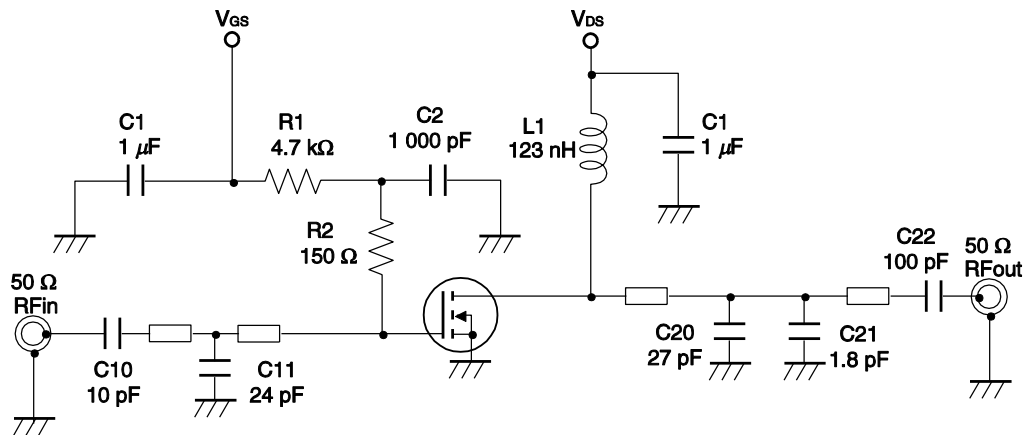

The application circuits and their parameters are for reference only and are not intended for use in actual design-ins.

COMPONENTS OF TEST CIRCUIT FOR MEASURING ELECTRICAL CHARACTERISTICS

Symbol	Value	Type	Maker
C1	1 μF	GRM31CR72A105KA01B	Murata
C2	1 000 pF	GRM1882C1H102JA01	Murata
C10	10 pF	GRM1882C1H100JA01	Murata
C11	24 pF	ATC100A240JW	American Technical Ceramics
C20	27 pF	ATC100A270JW	American Technical Ceramics
C21	1.8 pF	ATC100A1R8BW	American Technical Ceramics
C22	100 pF	ATC100A101JW	American Technical Ceramics
R1	4.7 kΩ	1/8W Chip Resistor	-
R2	150 Ω	1/8W Chip Resistor	-
L1	123 nH	φ 0.5 mm, φ D = 3 mm, 10 Turns	Ohesangyou
PCB	-	R4775, t = 0.4 mm, εr = 4.5, size = 30 × 48 mm	-

ILLUSTRATION OF THE TEST CIRCUIT ASSEMBLED ON EVALUATION BOARD

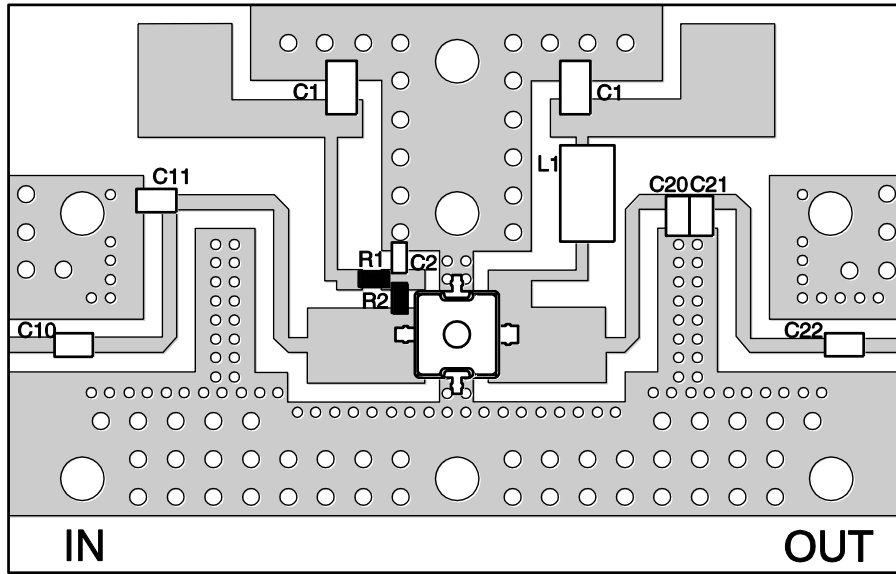

USING THE EVALUATION BOARD

Symbol	Value
C1	1 μ F
C2	1 000 pF
C10	10 pF
C11	24 pF
C20	27 pF
C21	1.8 pF
C22	100 pF
R1	4.7 k Ω
R2	150 Ω
L1	123 nH

TYPICAL CHARACTERISTICS ($T_A = +25^\circ\text{C}$, $I_{Dset} = 200\text{ mA}$, unless otherwise specified)

OUTPUT POWER, DRAIN CURRENT vs. INPUT POWER

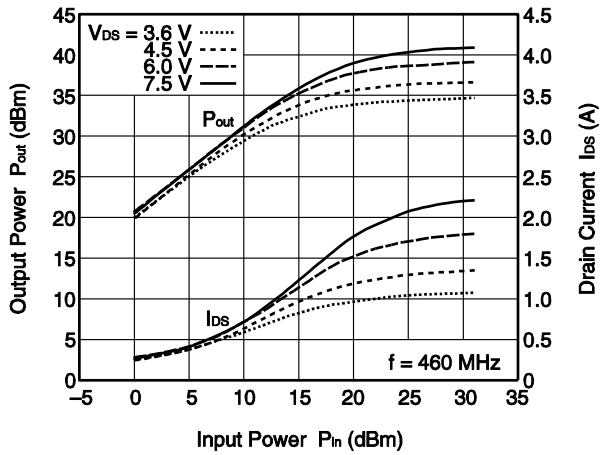

POWER GAIN, POWER ADDED EFFICIENCY vs. INPUT POWER

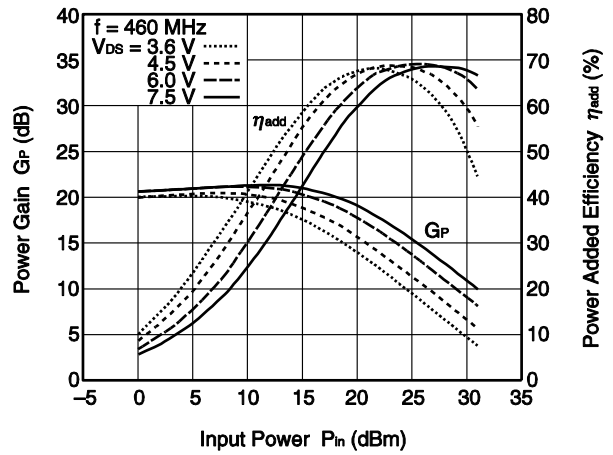

2fo, 3fo vs. OUTPUT POWER

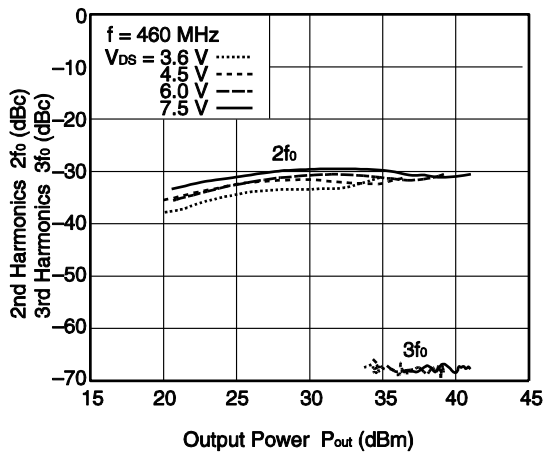

IM3/IM5 vs. 2 TONES OUTPUT POWER

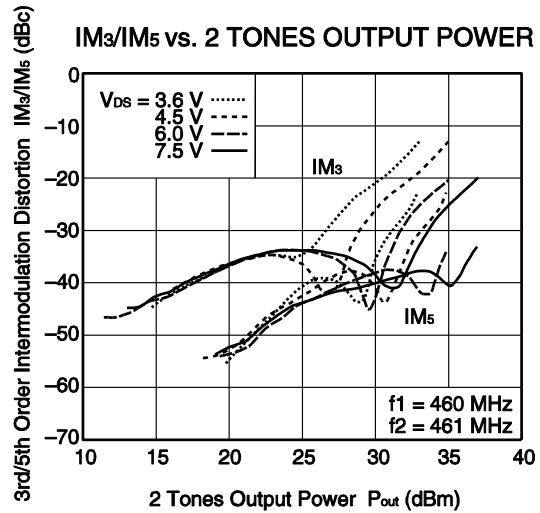

Remark The graphs indicate nominal characteristics.

S-PARAMETERS

- S-parameters and noise parameters are provided on our Web site in a format (S2P) that enables the direct import of the parameters to microwave circuit simulators without the need for keyboard inputs.
- [Click here to download S-parameters.](#)
- [\[RF and Microwave\] ® \[Device Parameters\]](#)
- URL <http://www.necel.com/microwave/en/>

PACKAGE DIMENSIONS

79A (UNIT: mm)

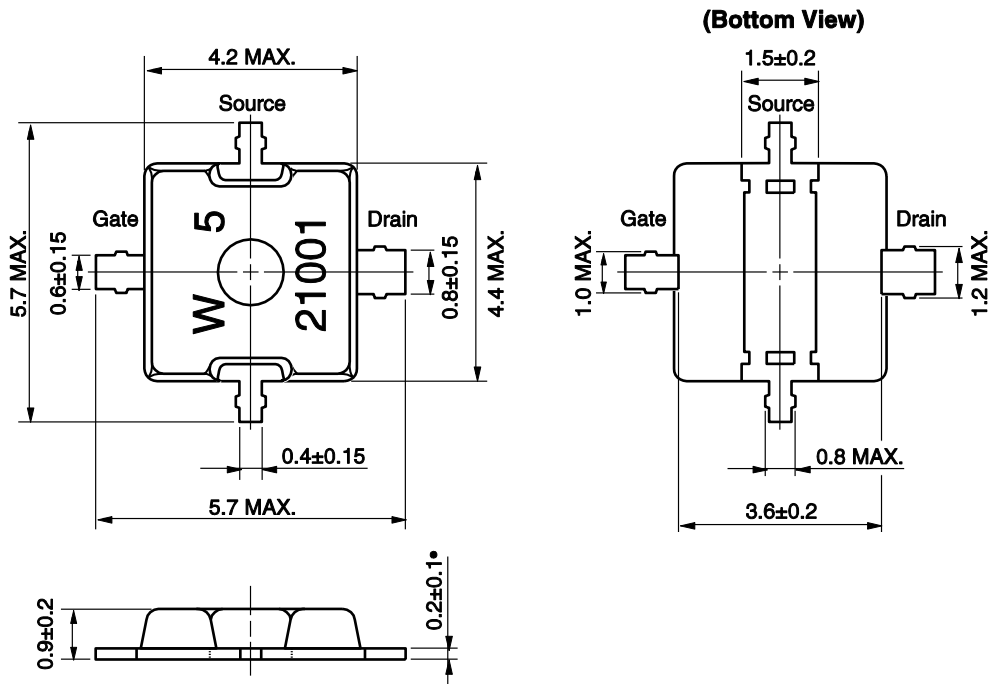

79A PACKAGE RECOMMENDED P.C.B. LAYOUT (UNIT: mm)

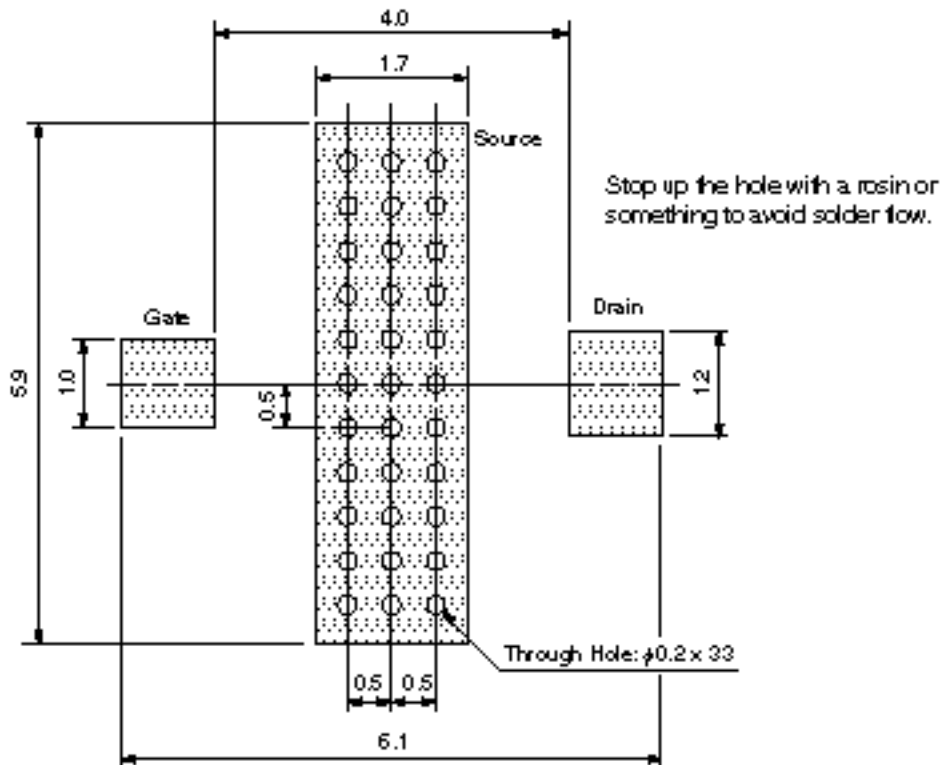

RECOMMENDED SOLDERING CONDITIONS

This product should be soldered and mounted under the following recommended conditions. For soldering methods and conditions other than those recommended below, contact your nearby sales office.

Soldering Method	Soldering Conditions	Condition Symbol
Infrared Reflow	Peak temperature (package surface temperature) : 260°C or below Time at peak temperature : 10 seconds or less Time at temperature of 220°C or higher : 60 seconds or less Preheating time at 120 to 180°C : 120±30 seconds Maximum number of reflow processes : 3 times Maximum chlorine content of rosin flux (% mass) : 0.2%(Wt.) or below	IR260
Wave Soldering	Peak temperature (molten solder temperature) : 260°C or below Time at peak temperature : 10 seconds or less Preheating temperature (package surface temperature) : 120°C or below Maximum number of flow processes : 1 time Maximum chlorine content of rosin flux (% mass) : 0.2%(Wt.) or below	WS260
Partial Heating	Peak temperature (pin temperature) : 350°C or below Soldering time (per pin of device) : 3 seconds or less Maximum chlorine content of rosin flux (% mass) : 0.2%(Wt.) or below	HS350-P3

Caution Do not use different soldering methods together (except for partial heating).