

**High Current Step-Down Converter
with High-Precision Programmable Current Limited Load Switch**

General Description

The AAT2138 is a high current synchronous step-down converter with an integrated current-limited load switch designed for high precision current control applications. By guarding against excessive input current, AAT2138 enables the system designer to maximize the output current from the step-down converter while protecting the input supply. It is designed for protection of USB ports from heavy load transient conditions commonly seen with high data rate modem applications.

AAT2138 integrates a high precision programmable current limited P-channel MOSFET load switch to protect the input supply against large currents which may cause the supply to fall out of regulation. The current limit threshold is programmed up to 3A by an external resistor between RSET and ground.

The AAT2138 is a 2.8MHz current mode step-down converter. It utilizes a tiny 1µH inductor and internal compensation to enable it to have an extremely small footprint. The regulator supports 100% duty cycle operation for dropout conditions. An external clock in the range of 1MHz to 3MHz can be fed into MODE as a synchronous signal for the step-down regulator. This feature offers the flexibility of fine tuning the switching frequency and optimizing performance in the application.

AAT2138 is available in a Pb-free, low profile, 14-pin 3mm x 3mm TDFN package. The product is rated over the -40°C to 85°C temperature range.

Features

- Input Voltage Range: 2.7V to 5.5 V
- Output Voltage Range: Down to 3.0V
- Current-Limited Load Switch
 - ±10% High Precision
 - Programmable Current Limit Range: 500mA to 3A
- High-Current Step-Down Converter
 - Efficiency up to 95%
 - 85mΩ High-Side; 50mΩ Low-Side FETs
 - 2.8MHz Switching Frequency
 - 100% Low Dropout Operation
 - No External Compensation Required
 - PFM/PWM or forced PWM Modes
 - 1MHz to 3MHz External Clock Support
- Soft Start
- Independent Enable Pins for Switch and Converter
- Over-Temperature and Over Load Protection
- -40°C to +85°C Temperature Range
- Pb-Free, Low-Profile, 3mmx3mm 14-pin TDFN Package

Applications

- Wireless Modem Data Cards
- Portable Hard Drives
- Portable Memory Card Readers
- Barcode Scanners
- Credit Card Readers
- General USB Powered Devices

Typical Application

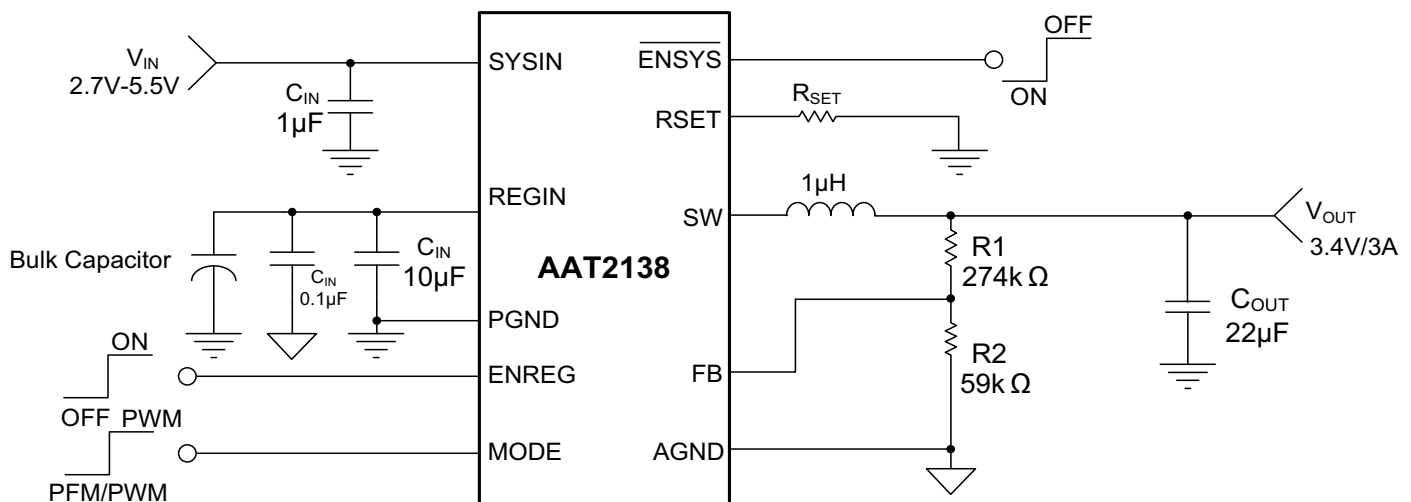

AAT2138

High Current Step-Down Converter with High-Precision Programmable Current Limited Load Switch

Pin Descriptions

Pin #	Symbol	Function
1, 2	PGND	Power Ground. PGND is internally connected to the source of the low-side N-channel MOSFET.
3, 4	REGIN	Input Power Supply for the Step-Down Regulator. Connect REGIN to the input power source. Bypass REGIN to PGND with a 4.7 μ F or greater ceramic capacitor. REGIN internally connects to the source of the load switch output and the step-down regulator's high-side P-channel MOSFET (see the Functional Block Diagram).
5	ENREG	Step-Down Regulator Enable Input. A logic high enables the AAT2138 switching regulator. A logic low forces the AAT2138 into shutdown mode, placing the output into a high-impedance state and reducing the quiescent current to less than 1 μ A. Do NOT leave ENREG floating.
6	RSET	Load Switch Current-Limit Adjustment. Connect a resistor between RSET and ground to set the input current limit threshold.
7	AGND	Analog Ground. AGND is internally connected to the analog ground of the control circuitry.
8	$\overline{\text{ENSYS}}$	Load Switch Enable. Active Low Input. A logic low enables the AAT2138 load switch. A logic high disables the AAT2138 load switch. Do NOT leave $\overline{\text{ENSYS}}$ floating.
9	FB	Feedback Input / Output Voltage Sense. FB senses the output voltage for regulation control. For adjustable output versions, connect a resistive divider network from the output to FB to GND to set the output voltage accordingly. The FB regulation threshold is 0.6V.
10	MODE	Regulator Operating Mode. Pull MODE high to force the regulator into forced PWM operation. Pull MODE low to allow automatic pulse-skipping under light-load operation. An external clock in the range of 1MHz to 3MHz can be connected into MODE as a synchronous clock signal for the step-down converter to bypass the internal oscillator.
11, 12	SYSIN	System Load Switch Input. SYSIN connects to the source of the P-channel load switch that limits the system input supply current. Bias Input Supply for the System and Step-Down Regulator. SYSIN supplies power to the analog and logic control circuitry of the AAT2138.
13, 14	SW	Inductor Switching Node. SW is internally connected to the source of the high-side P-Channel MOSFET and the drain of the low-side N-channel MOSFET. Externally connected to the power inductor as shown in the Typical Application Circuit.
EP	GND (EP)	Exposed Pad. Connect directly to the ground plane to reduce the thermal impedance.

Pin Configuration

**TDFN33-14
(Top View)**

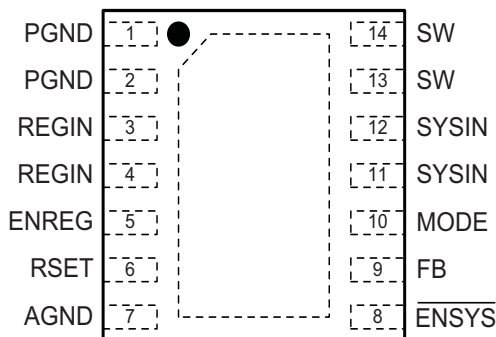

**High Current Step-Down Converter
with High-Precision Programmable Current Limited Load Switch**

Absolute Maximum Ratings¹

Symbol	Description	Value	Units
V _{IN}	SYSIN, REGIN to PGND	-0.3 to +6	V
V _{SW}	SW to PGND	-0.3 to (REGIN + 0.3)	
V _{FB}	FB to AGND	-0.3 to (SYSIN + 0.3)	
V _{RSET}	RSET to AGND	-0.3 to (V _{IN} + 0.3)	
V _{EN}	ENSYS, ENREG to AGND	-0.3 to (V _{IN} + 0.3)	
I _{SYSIN}	Load Switch Maximum RMS Current Capability	±4.0	A
V _{GND}	PGND to AGND	-0.3 to +0.3	V
T _J	Operating Junction Temperature Range	-40 to 150	°C
T _A	Operating Ambient Temperature Range	-40 to 85	
T _{LEAD}	Maximum Soldering Temperature (at leads, 10 sec)	300	

Thermal Characteristics

Symbol	Description	Value	Units
Θ _{JA}	Maximum Thermal Resistance	60	°C/W
P _D	Maximum Power Dissipation ^{2, 3}	1.67	W

1. Stresses above those listed in Absolute Maximum Ratings may cause permanent damage to the device. Functional operation at conditions other than the operating conditions specified is not implied.

2. Mounted on an FR4 board.

3. Derate 70mW/°C above 25°C.

High Current Step-Down Converter with High-Precision Programmable Current Limited Load Switch

Electrical Characteristics¹

$V_{\text{SYSIN}} = 5.0\text{V}$, $\text{ENREG} = \text{SYSIN}$, $\text{ENSYS} = \text{AGND} = \text{PGND}$, $T_A = -40^\circ\text{C}$ to 85°C unless otherwise noted. Typical values are at $T_A = 25^\circ\text{C}$.

Symbol	Description	Conditions	Min	Typ	Max	Units
V_{SYSIN}	System Input Voltage Range	SYSIN, REGIN	2.7		5.5	V
$V_{\text{UVLO(SYSIN)}}$	System Input Under-Voltage Lockout	SYSIN Rising			2.7	
		Hysteresis		0.2		
$V_{\text{UVLO(REGIN)}}$	Regulator Input Under-Voltage Lockout	REGIN Rising ²			2.7	
		Hysteresis		0.2		
$V_{\text{DIS(SYSIN)}}$	Regulator Input Discharge Threshold	SYSIN Rising		3.15		
		Hysteresis		0.15		
R_{DISCHRG}	Discharge MOSFET On-Resistance	$V_{\text{SYSIN}} = V_{\text{REGIN}} = 3.6\text{V}$		8		Ω
T_{SHDN}	Over-Temperature Shutdown Threshold	Hysteresis = 15°C		150		$^\circ\text{C}$
I_Q	No Load Supply Current	No Load Current; Not Switching		90		μA
I_{SHDN}	Shutdown Current	ENREG = SW = GND,			1	
System Input Load Switch						
$R_{\text{DS(ON)}}$	Load Switch On-Resistance	$V_{\text{SYSIN}} = 5.0\text{V}$, $T_A = 25^\circ\text{C}$		85		$\text{m}\Omega$
Δ_{ISYSILIM}	Current Limit Accuracy	$R_{\text{SET}} = 6.4\text{k}\Omega$, $V_{\text{REGIN}} < V_{\text{UVLO(REGIN)}}$, $T_A = 20^\circ\text{C}$ to 85°C	-10	± 5	10	%
	Short-Circuit Current-Limit Threshold	$R_{\text{SET}} = 6.4\text{k}\Omega$, $V_{\text{REGIN}} < V_{\text{UVLO(REGIN)}}$, $T_A = 20^\circ\text{C}$ to 85°C		400		mA
	Adjustable Current-Limit Range	$T_A = 25^\circ\text{C}$	0.5		3	A
t_{ILIM}	Current-Limit Response Time			5		μs
$t_{\text{SS(SYS)}}$	Load Switch Soft-Start Period			1.5		ms
$V_{\text{IH_ENSYS}}$	ENSYS Input Logic Threshold High		1.5			V
$V_{\text{IL_ENSYS}}$	ENSYS Input Logic Threshold Low				0.4	
I_{ENSYS}	ENSYS Input Current	$V_{\text{EN}} = 0\text{V}$ or $< V_{\text{IN}} + 0.3\text{V}$	-1.0		1.0	μA
Step-Down Regulator						
V_{OUT}	Output Voltage Range		3.0		V_{IN}	V
I_{FB}	FB Leakage Current	$V_{\text{FB}} = 0.65\text{V}$			50	nA
V_{FB}	FB Regulation Threshold ³	10mA Load, $T_A = +25^\circ\text{C}$	588	600	612	mV
		No Load, $T_A = -40^\circ\text{C}$ to $+85^\circ\text{C}$	582	600	618	
$\Delta_{\text{VOUT}/I_{\text{OUT}}}$	Load Regulation	$I_{\text{OUT}} = 0$ to 2.5A , $T_A = 25^\circ\text{C}$		0.20		%/A
$\Delta_{\text{VOUT}}/V_{\text{IN}}$	Line Regulation	$V_{\text{IN}} = 3.6\text{V}$ to 5.5V , $V_{\text{OUT}} = 3.3\text{V}$, $T_A = 25^\circ\text{C}$, $I_{\text{OUT}} = 10\text{mA}$		0.10	0.30	%/V
I_{LIMPK}	High-Side P-Channel MOSFET Current Limit		3.0	4.0		A
$R_{\text{DS(ON)HI}}$	High-Side P-Channel MOSFET On-Resistance	$V_{\text{REGIN}} = 3.6\text{V}$		85		$\text{m}\Omega$
$R_{\text{DS(ON)LO}}$	Low-Side N-Channel MOSFET On-Resistance	$V_{\text{REGIN}} = 3.6\text{V}$		50		$\text{m}\Omega$
f_{OSC}	Internal Oscillator Frequency		2.4	2.8		MHz
$t_{\text{SS(REG)}}$	Step-Down Regulator Soft-Start Period ⁴	$C_{\text{OUT}} = 100\mu\text{F}$		1		ms
t_{OFF}	Minimum Off-time			50		ns
$V_{\text{IH_ENREG}}$	ENREG Input Logic Threshold High		1.5			V
$V_{\text{IL_ENREG}}$	ENREG Input Logic Threshold Low				0.4	V
I_{ENREG}	ENREG Input Current	$V_{\text{EN}} = 0\text{V}$ or $5.5\text{V} < V_{\text{IN}} + 0.3\text{V}$	-1.0		1.0	μA

1. The AAT2138 is guaranteed to meet performance specifications over the -40°C to $+85^\circ\text{C}$ operating temperature range and is assured by design, characterization, and correlation with statistical process controls.

2. Also used for Load Switch Current-Limit Fold-back Threshold

3. The regulated feedback voltage is tested in an internal test mode that connects V_{FB} to the output of the error amplifier.

4. This time period will keep the regulator start-up current around 300mA to 400mA.

High Current Step-Down Converter with High-Precision Programmable Current Limited Load Switch

Typical Characteristics

Step-Down Converter Efficiency
($V_{OUT} = 3.4V$)

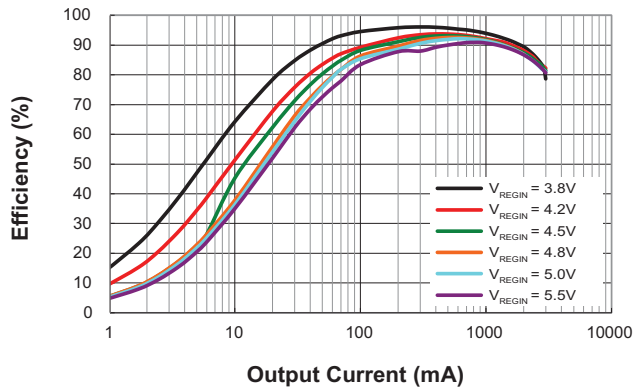

Step-Down Converter Efficiency
($V_{OUT} = 3.65V$)

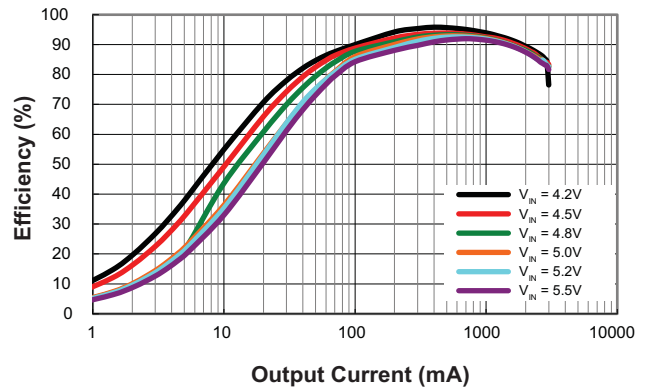

Step-Down Converter Efficiency
($V_{OUT} = 3.8V$)

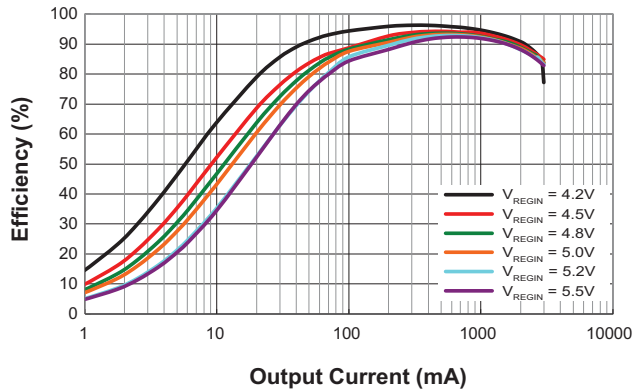

Step-Down Converter Load Regulation
($V_{OUT} = 3.4V$)

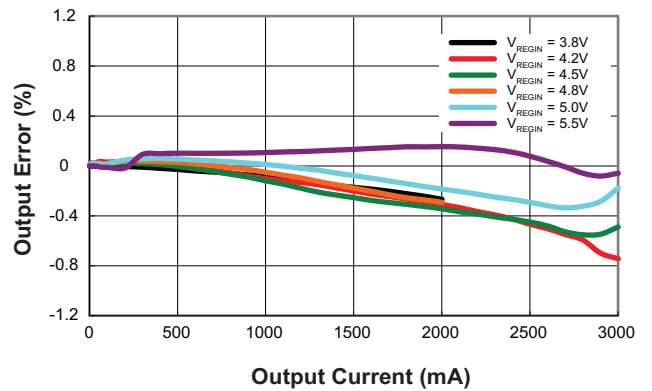

Step-Down Converter Load Regulation
($V_{OUT} = 3.8V$)

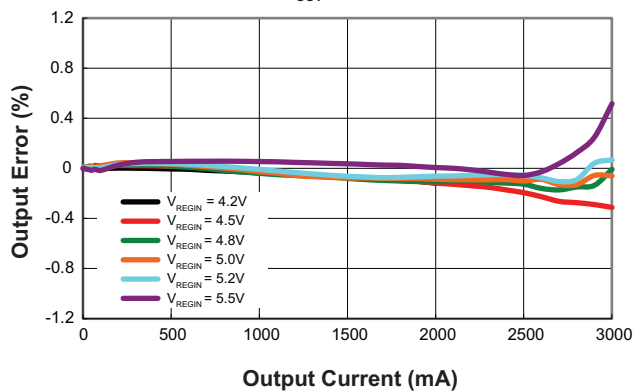

Step-Down Converter Line Regulation
($V_{OUT} = 3.4V$)

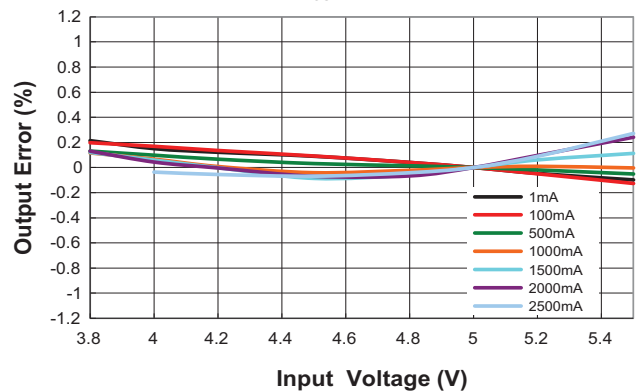

AAT2138

High Current Step-Down Converter with High-Precision Programmable Current Limited Load Switch

Typical Characteristics

Step-Down Converter Line Regulation
($V_{OUT} = 3.8V$)

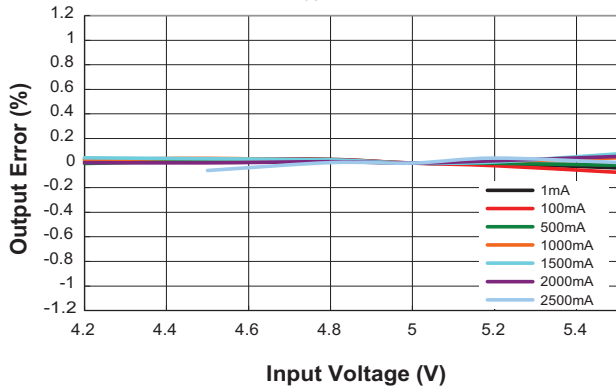

Frequency vs Temperature

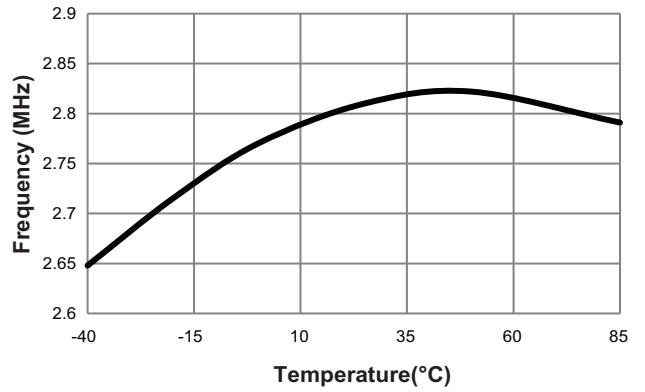

Feedback Voltage vs Temperature

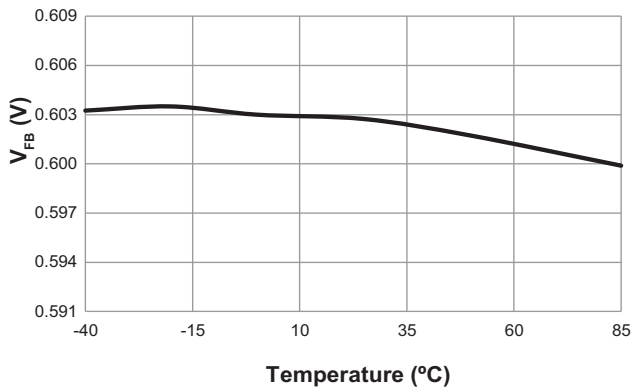

Feedback Voltage vs Input Voltage

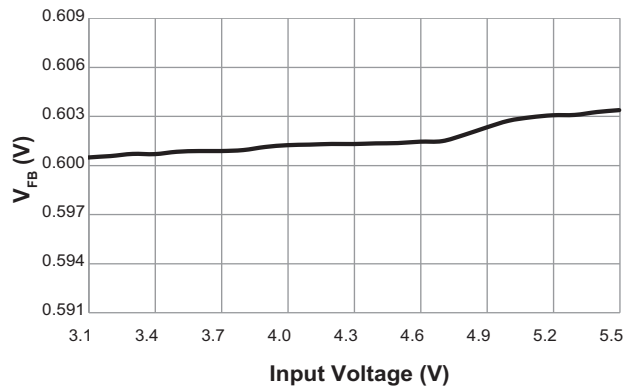

Step-Down Converter Enable Threshold vs Input Voltage

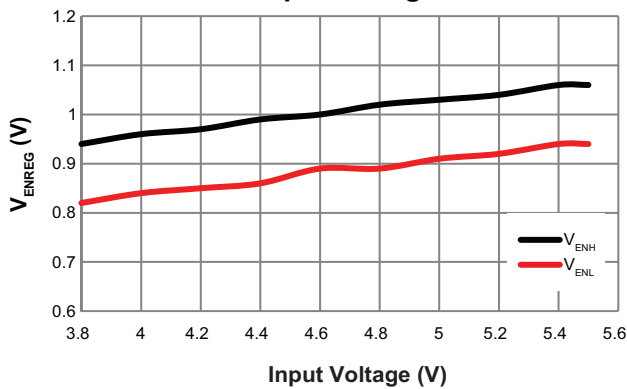

Step-Down Converter Enable Threshold vs Temperature

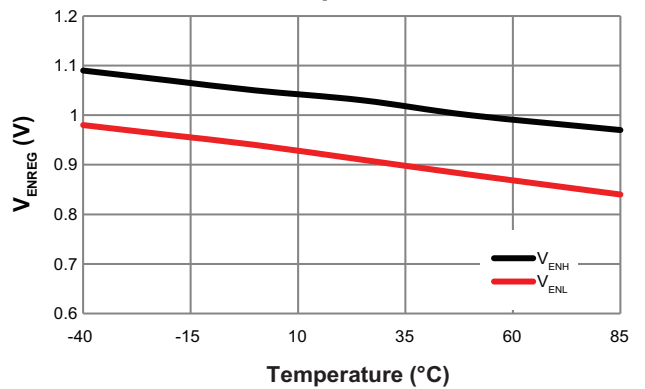

AAT2138

High Current Step-Down Converter with High-Precision Programmable Current Limited Load Switch

Typical Characteristics

No Load Quiescent Current vs Input Voltage
(Open Loop)

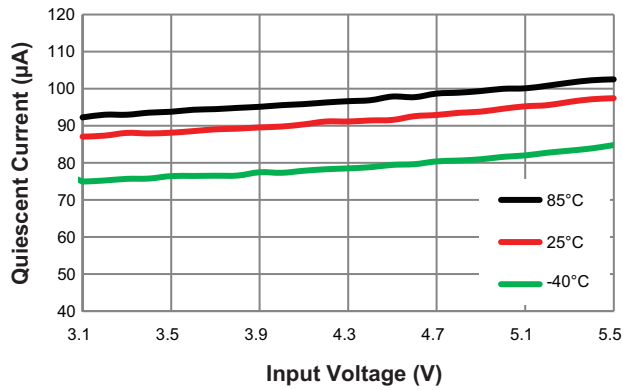

No Load Quiescent Current vs Temperature
(Open Loop, $V_{SYSIN} = 5V$)

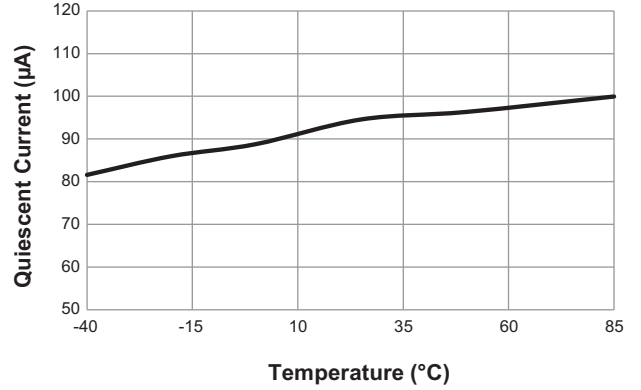

No Load Quiescent Current vs Input Voltage
(Close Loop, $V_{OUT} = 3.4V$)

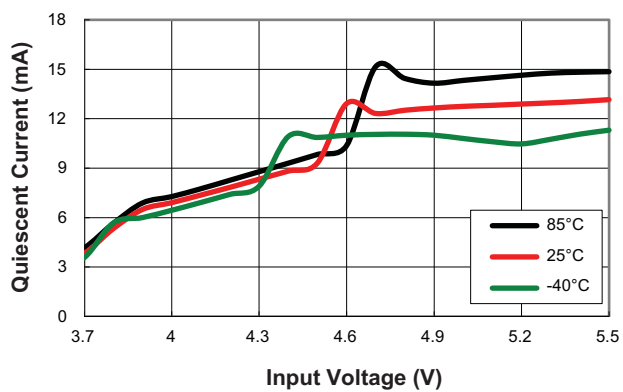

No Load Quiescent Current vs Temperature
(Close Loop, $V_{SYSIN} = 5V, V_{OUT} = 3.4V$)

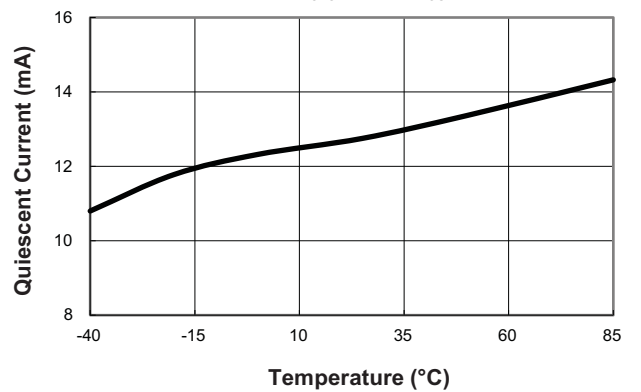

Step-Down Converter P-Channel $R_{DS(ON)}$ vs Input Voltage

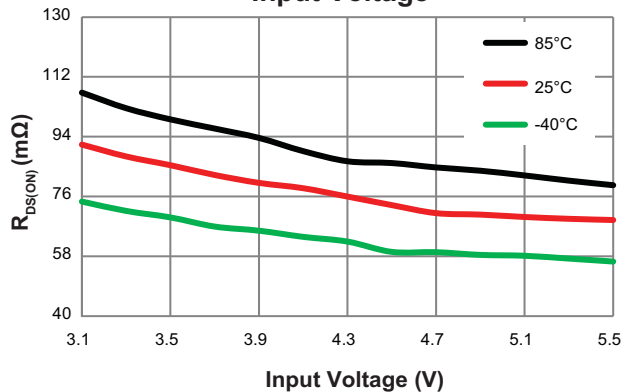

Step-Down Converter N-Channel $R_{DS(ON)}$ vs Input Voltage

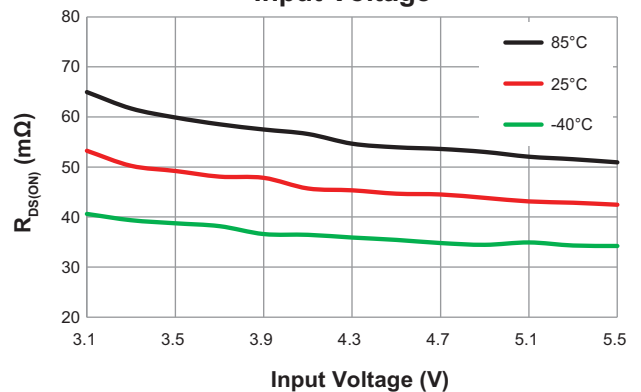

AAT2138

High Current Step-Down Converter with High-Precision Programmable Current Limited Load Switch

Typical Characteristics

Soft Start

($V_{SYSIN} = V_{REGIN} = 5V$, $C_{OUT} = 22\mu F$, $L = 1\mu H$, $V_{OUT} = 3.4V$,
 $I_{OUT} = 2.5A$)

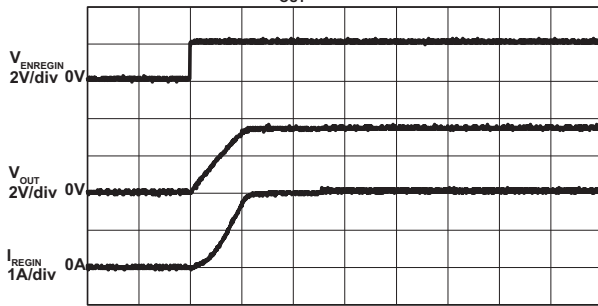

Time 1ms/div

Soft Start

($V_{SYSIN} = V_{REGIN} = 5V$, $C_{OUT} = 22\mu F$, $V_{OUT} = 3.4V$,
 $L = 1\mu H$, $I_{OUT} = 0A$)

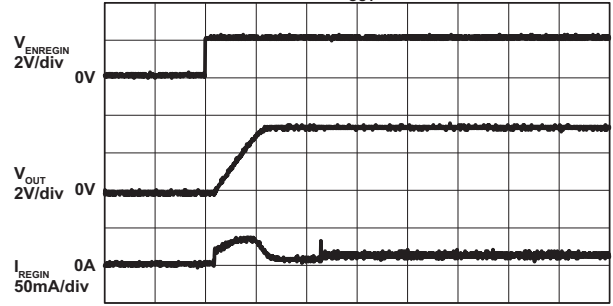

Time 1ms/div

Output Ripple

($V_{SYSIN} = V_{REGIN} = 5V$, PFM Mode, $L = 1\mu H$, $C_{OUT} = 22\mu F$,
 $C_{REGIN} = 10\mu F + 0.1\mu F$, $V_{OUT} = 3.4V$, $I_{OUT} = 10mA$)

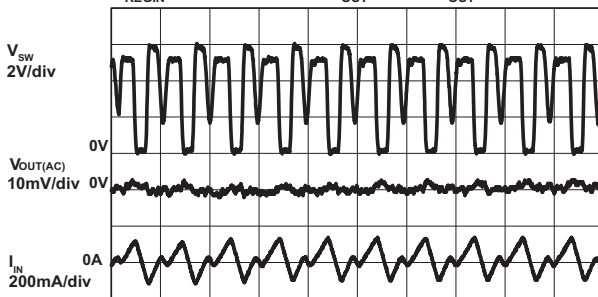

Time 400ns/div

Output Ripple

($V_{SYSIN} = V_{REGIN} = 5V$, PWM Mode, $L = 1\mu H$, $C_{OUT} = 22\mu F$,
 $C_{REGIN} = 10\mu F + 0.1\mu F$, $V_{OUT} = 3.4V$, $I_{OUT} = 10mA$)

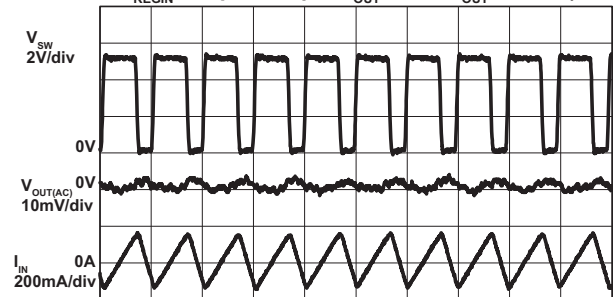

Time 400ns/div

Output Ripple

($V_{SYSIN} = V_{REGIN} = 5V$, PWM Mode, $L = 1\mu H$, $C_{OUT} = 22\mu F$,
 $C_{REGIN} = 10\mu F + 0.1\mu F$, $V_{OUT} = 3.4V$, $I_{OUT} = 2A$)

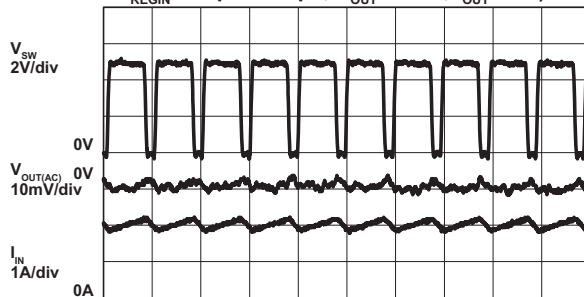

Time 400ns/div

Step-Down Converter Load Transient

($V_{SYSIN} = V_{REGIN} = 5V$, $V_{OUT} = 3.8V$,
 $C_{COUT} = 22\mu F$, $L = 1\mu H$, $C_{FF} = 22pF$, $C_{REGIN} = 10\mu F + 0.1\mu F$)

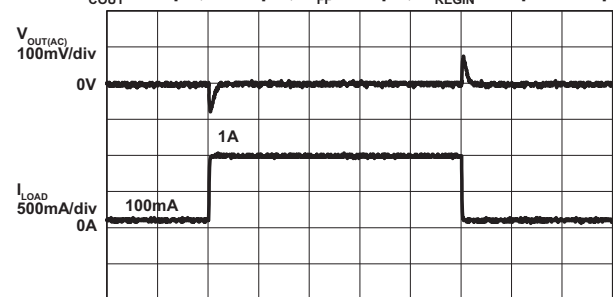

Time 100µs/div

AAT2138

High Current Step-Down Converter with High-Precision Programmable Current Limited Load Switch

Typical Characteristics

Step-Down Converter Load Transient

($V_{SYSIN} = V_{REGIN} = 5V, V_{OUT} = 3.8V, C_{COUT} = 22\mu F, L = 1\mu H,$
 $C_{FF} = 22pF, C_{REGIN} = 10\mu F + 0.1\mu F$)

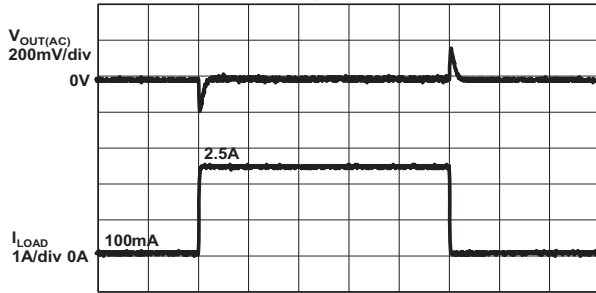

Time 100µs/div

Step-Down Converter Load Transient

($V_{SYSIN} = V_{REGIN} = 5V, V_{OUT} = 3.4V,$
 $C_{COUT} = 22\mu F, L = 1\mu H, C_{FF} = 22pF, C_{REGIN} = 10\mu F + 0.1\mu F$)

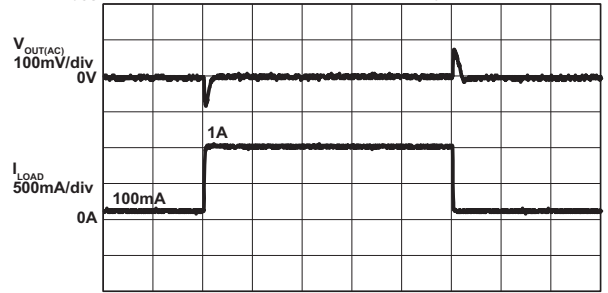

Time 100µs/div

Step-Down Converter Load Transient

($V_{SYSIN} = V_{REGIN} = 5V, V_{OUT} = 3.4V, C_{COUT} = 22\mu F, L = 1\mu H,$
 $C_{FF} = 22pF, C_{REGIN} = 10\mu F + 0.1\mu F$)

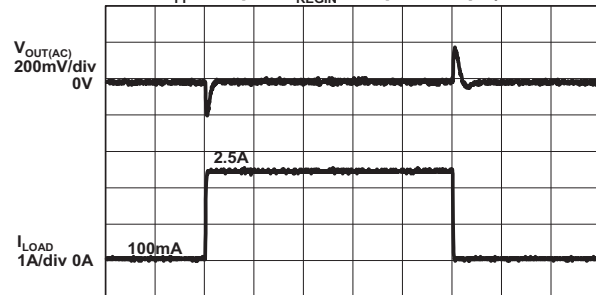

Time 100µs/div

Step-Down Converter Line Transient

($I_{OUT} = 100mA, V_{OUT} = 3.8V, C_{COUT} = 22\mu F, L = 1\mu H, C_{FF} = 22pF,$
 $C_{REGIN} = 10\mu F + 0.1\mu F$)

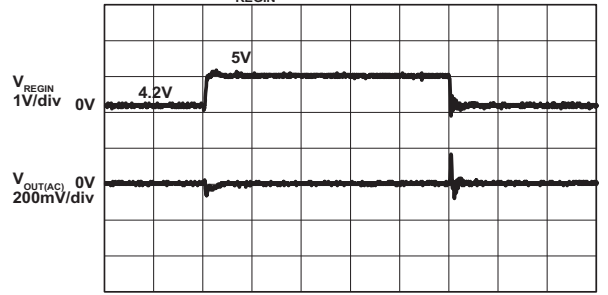

Time 100µs/div

Step-Down Converter Line Transient

($I_{OUT} = 100mA, V_{OUT} = 3.4V, C_{COUT} = 22\mu F,$
 $L = 1\mu H, C_{FF} = 22pF, C_{REGIN} = 10\mu F + 0.1\mu F$)

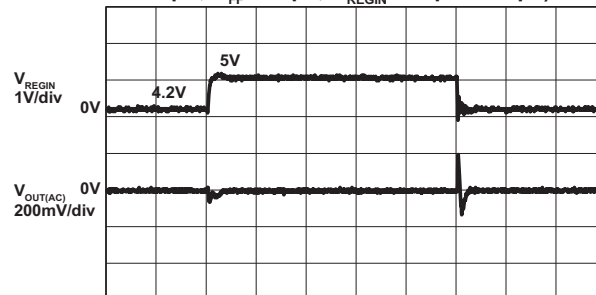

Time 100µs/div

Load Switch Enable Threshold vs Input Voltage

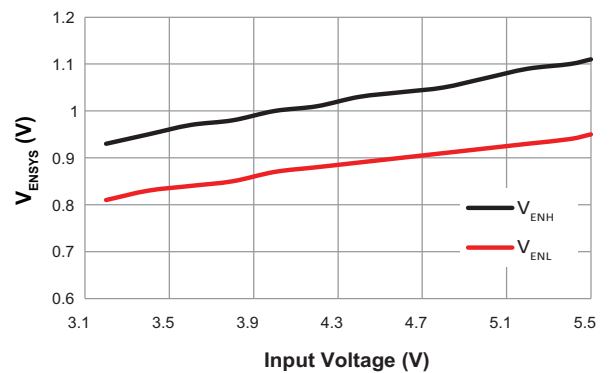

AAT2138

High Current Step-Down Converter with High-Precision Programmable Current Limited Load Switch

Typical Characteristics

Load Switch Enable Threshold vs Temperature

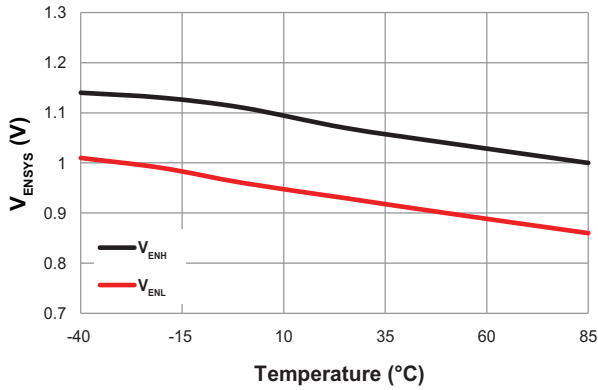

Load Switch R_{DS(ON)} vs Input Voltage

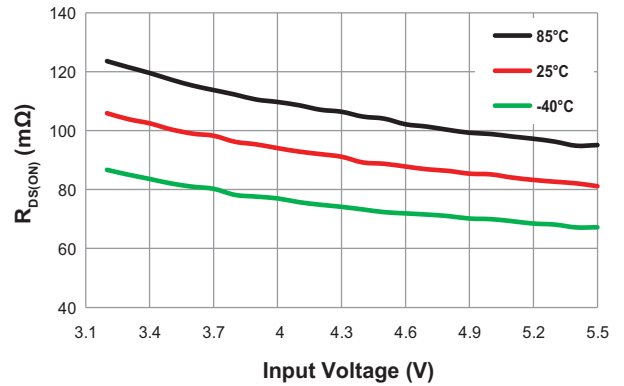

Load Switch Turn on

(V_{SYN} = 5V, C_{SYN} = 1μF, C_{REG} = 10μF + 0.1μF, R_L = 100Ω)
(V_{OUT} = 3.4V)

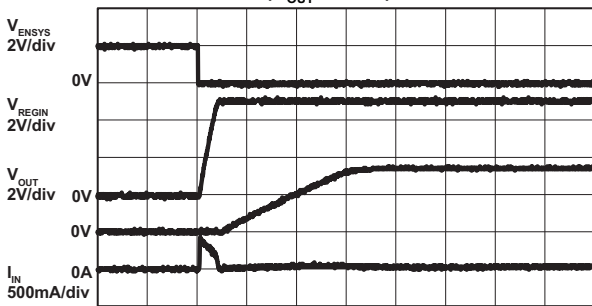

Time 400μS/div

Load Switch Turn off

(V_{SYN} = 5V, C_{SYN} = 1μF, C_{REG} = 10μF + 0.1μF, R_L = 100Ω)
(V_{OUT} = 3.4V)

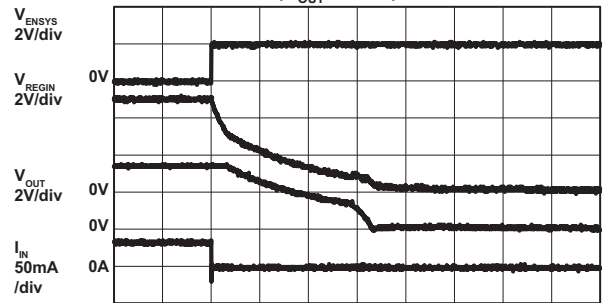

Time 1ms/div

Load Switch Turn On

(V_{SYN} = 5V, C_{SYN} = 1μF, C_{REG} = 10μF + 0.1μF + 680μF, R_L = 100Ω)
(V_{OUT} = 3.4V)

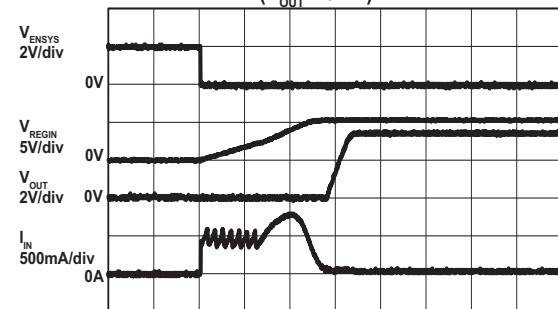

Time 2ms/div

REGIN Discharge Function

(V_{SYN} from 5V to 3V, C_{SYN} = 1μF, C_{REG} = 10μF + 0.1μF)

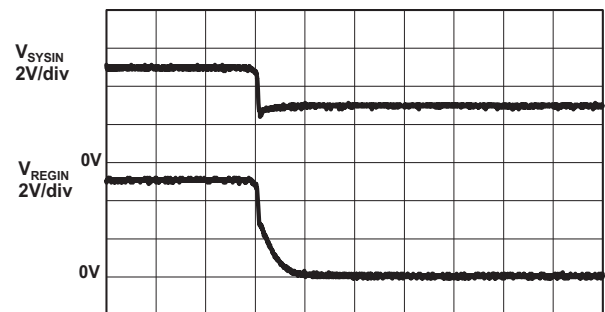

Time 400μs/div

High Current Step-Down Converter with High-Precision Programmable Current Limited Load Switch

Functional Block Diagram

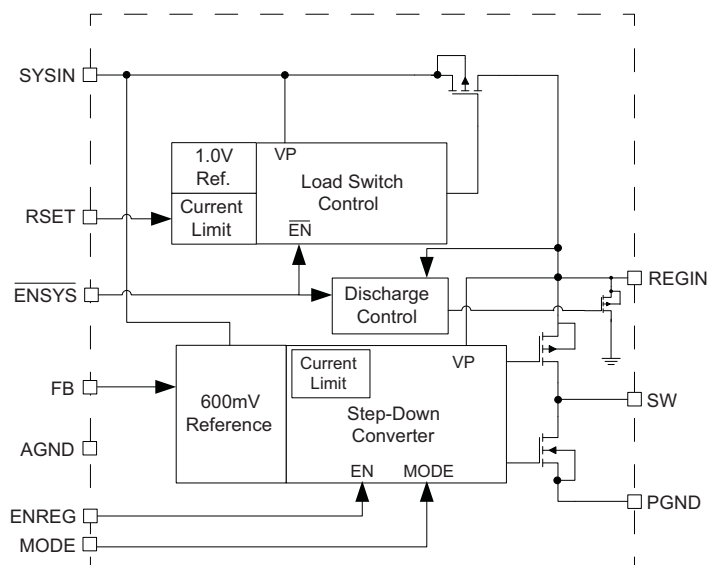

Functional Description

The AAT2138 is a high performance, 2.8MHz, synchronous step-down converter with a high-precision, programmable current limited P-channel load switch up to 3A.

The P-channel load switch is adopted to limit the system input current. The current limit value is programmed by external resistor between RSET and GND. Its fast transient response time makes it ideal to protect the system from input power surges.

The AAT2138 employs internal error amplifier and compensation. It provides excellent transient response, load and line regulation. Its output voltage is programmed by an external resistor divider from 3.0V to converter input voltage. Soft start eliminates any output voltage overshoot when the enable or input voltage is applied. Dropout mode makes the converter increase the switch duty cycle to 100% and the output voltage tracks the input voltage minus the $R_{DS(ON)}$ drop of the P-channel high-side MOSFET of the converter.

The AAT2138's input voltage range is 2.7V to 5.5V. Two independent enable pins control the load switch and step-down converter separately. The converter efficiency has been optimized for a 1 μ H inductor.

Control Scheme

The AAT2138 uses a peak current-mode step-down con-

trol scheme. The converter senses the current through the high-side P-channel MOSFET for current loop control as well as overload protection. A fixed slope compensation signal is added to the sensed current to maintain stability for duty cycles greater than 50%. The input current of the step-down converter is limited by the load switch.

The feedback amplifier compares the FB voltage against the 0.6V reference voltage. The error amplifier's transconductance output is internally compensated, and programs the current-mode loop for the necessary peak switch current to force a constant output voltage over all load and line conditions.

Enable/Soft Start

AAT2138 has two independent enable pins: \overline{ENSYS} and ENREG. When \overline{ENSYS} is pulled high, the current limit load switch is turned off and REGIN drops to zero. When ENREG is pulled low, the step-down converter is forced into the low-power, no-switching, high impedance state. The total input current during shutdown is less than 1 μ A.

When \overline{ENSYS} is pulled low, the system will turn on the load switch in a soft start process. To avoid a big inrush current during the startup, the REGIN voltage will be charged from SYSIN with limited input current under 500mA. The startup time depends on the capacitance between REGIN and GND.

When ENREG is pulled high, the step-down converter is

High Current Step-Down Converter with High-Precision Programmable Current Limited Load Switch

active with soft start. When the REGIN voltage is above UVLO and reaches 95% of V_{SYSIN} voltage, the reference voltage is charged from 0 to 0.6V slowly by an internal current source to avoid a large input inrush current. During the soft start, the output voltage increases with the reference voltage. The soft start time is about 1ms with a 100 μ F output capacitor.

REGIN Discharge

The voltage on the capacitor between REGIN and GND is discharged quickly when the power on SYSIN is removed quickly (unplugged adaptor). When \overline{EN}_{SYS} is pulled low and SYSIN is below 3.0V, AAT2138 automatically turns on the discharge MOSFET to discharge the REGIN capacitor storage. Discharge resistance is typical 80 Ω and the specific discharge time depends on the capacitance between REGIN and GND.

Input Under-Voltage Lockout

Under-voltage lockout (UVLO) guarantees sufficient V_{REGIN} bias and proper operation of all internal circuitry prior to activation.

MODE Function

When the MODE pin is pulled high, the part runs in forced PWM mode operation using the internal oscillator. When the MODE pin is pulled low, a light-load mode operation (PFM/PWM) is designed to reduce the dominant switching losses at low output voltage and light-load condition.

The Step-Down converter can also be synchronized to an external clock signal fed into the MODE pin. In this case, the internal oscillator is bypassed. The frequency of the external clock must be in the range from 1MHz to 3MHz.

Protection Circuitry

The AAT2138 includes protection for overload and over-temperature conditions. The overload protection turns off the high-side switch when the inductor current exceeds the current-limit threshold (3A minimum).

The AAT2138 includes thermal protection that disables the regulator and the load switch when the die temperature reaches 150°C. The REGIN pin is maintained in a high-impedance state. It automatically restarts when the temperature drops by 15°C or more.

Application Information

Load Switch

Current Limit Setting

The AAT2138's load switch current limit can be programmed by an external resistor R_{SET} from RSET to GND. In most applications, the variation in I_{LIM} must be taken into account when determining R_{SET} . The I_{LIM} variation is due to processing variations from part to part, as well as variations in the voltages at SYSIN and REGIN, plus the operating temperature. Together, these three factors add up to a $\pm 5\%$ tolerance (see load switch I_{LIM} specification in Electrical Characteristics section). Table 1 gives 1% standard metal film resistor example values for PMOS current limit programming.

I_{LIM} (A)	R_{SET} (k Ω)
0.4	13.3
0.482	10
0.51	9.53
0.553	8.88
0.613	8.06
0.798	6.34
0.908	5.6
1.01	5.1
1.078	4.75
1.245	4.02
1.538	3.16
2.07	2.2
2.48	1.74
2.64	1.6
2.9	1.4
3	1.3

Table 1: Examples of 1% Standard Resistor Value of R_{SET} .

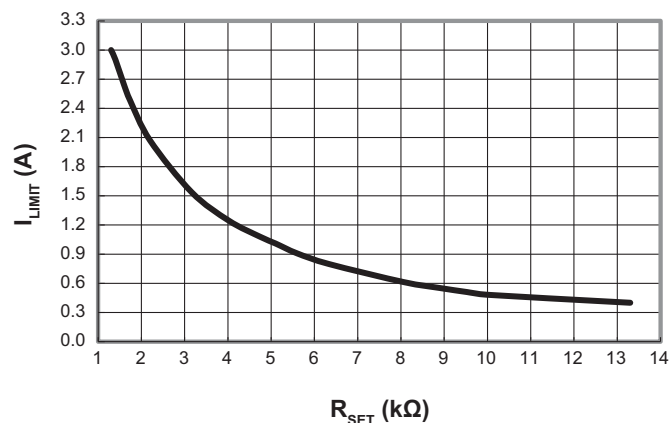

Figure 1: Load Switch Current Limit vs R_{SET} .

High Current Step-Down Converter with High-Precision Programmable Current Limited Load Switch

Dropout Voltage

Dropout voltage is determined by $R_{DS(ON)}$ and the current passing through it. AAT2138 load switch typical $R_{DS(ON)}$ is 80m Ω for USB application. So, for a 750mA load switch current limit setting, the load switch dropout voltage can be calculated by:

$$V_{DROPOUT_SWITCH} = 750\text{mA} \cdot 80\text{m}\Omega = 60\text{mV}$$

Step-Down Converter

Inductor Selection

The step-down converter uses peak current-mode control with slope compensation to maintain stability for duty cycles greater than 50%. The output inductor value must be selected so the inductor current down slope meets the internal slope compensation requirements. The inductor should be set equal to half the output voltage numeric value in μH . This guarantees that there is sufficient internal slope compensation.

Manufacturer's specifications list both the inductor DC current rating, which is a thermal limitation, and the peak current rating, which is determined by the saturation characteristics. The inductor should not show any appreciable saturation under normal load conditions. Some inductors may meet the peak and average current ratings yet result in excessive losses due to a high DCR. Always consider the losses associated with the DCR and its effect on the total converter efficiency when selecting an inductor.

C_{REGIN} Selection

C_{REGIN} is not only the load switch output capacitor but also the step-down converter input capacitor. It is designed to provide the additional input current and maintain the SYSOUT voltage for the step-down converter when load switch limits the input current from SYSIN. If the input voltage of the step-down converter is lower than the V_{OUT} plus the dropout voltage, the AAT2138 enters dropout mode. C_{REGIN} minimum value can be calculated by the following steps:

First, calculate the allowed maximum delta voltage on C_{REGIN} to keep V_{OUT} in regulation:

$$\Delta V_{REGIN} = V_{IN} - V_{OUT} - V_{DROPOUT_SWITCH} - V_{DROPOUT_BUCK}$$

Second, calculate the required input current at SYSOUT for the step-down converter:

$$I_{BUCKIN} = \frac{V_{OUT} \cdot I_{OUT}}{\left(V_{SYSIN} - V_{DROPOUT_SWITCH}\right) \cdot \eta}$$

Next, calculate the maximum current C_{REGIN} should provide:

$$I_{CREGIN} = I_{BUCKIN} - I_{LIM}$$

Finally, derive the C_{SYSOUT} at certain load on period T_{ON}

$$C_{REGIN_MIN} = \frac{I_{CREGIN} \cdot T_{ON}}{\Delta V_{REGIN}}$$

Example: A 2A, 217Hz, 12.5% load pulse is applied on 3.8V V_{OUT} in 5V V_{IN} and 750mA load switch current limit, under the condition, $V_{DROPOUT_SWITCH}$ is 0.06V, $V_{DROPOUT_BUCK}$ is 0.17V. Therefore, considering the step-down converter at 2A, 3.8V, V_{OUT} is 90%.

$$\Delta V_{REGIN} = 5 - 3.8 - 0.06 - 0.17 = 0.970\text{V}$$

$$I_{BUCKIN} = \frac{3.8 \cdot 2}{\left(5 - 0.06\right) \cdot 0.9} = 1.71\text{A}$$

$$I_{CREGIN} = 1.71 - 0.75 = 0.96\text{A}$$

t_{ON} is 576 μs for a 217Hz, 12.5% duty cycle load pulse.

$$C_{REGIN_MIN} = \frac{0.96 \cdot 576}{0.970} = 570\mu\text{F}$$

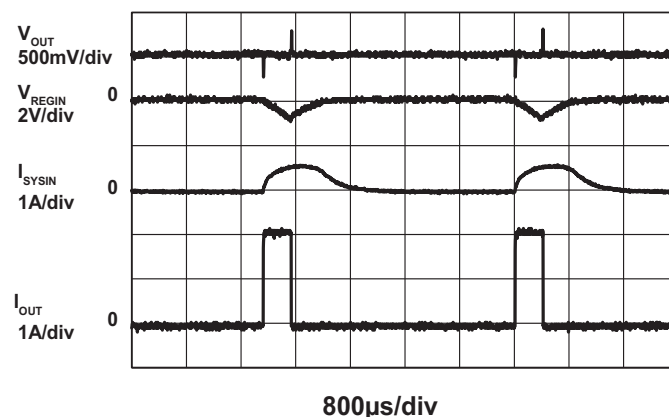

**Figure 2: AAT2138 Operation Waveform
2A, 577 μs Load Pulse (Applied)
 $V_{IN} = 5\text{V}$, $V_{OUT} = 3.8\text{V}$.**

High Current Step-Down Converter with High-Precision Programmable Current Limited Load Switch

Considering 20% capacitance tolerance, the minimum capacitance should be 684 μ F. So select a 680 μ F tantalum capacitor as C_{REGIN} , as well as an additional 10 μ F ceramic capacitor to closely filter the input voltage V_{REGIN} of the step-down converter on the PCB board.

Input Capacitor Selection

Select a 1 μ F X7R or X5R ceramic capacitor for the system input. To estimate the required input capacitor size, determine the acceptable input ripple level and solve for C_{IN} . The calculated value varies with input voltage and is a maximum when V_{IN} is twice the output voltage.

$$C_{\text{IN}} = \frac{\frac{V_{\text{OUT}}}{V_{\text{IN}}} \cdot \left(1 - \frac{V_{\text{OUT}}}{V_{\text{IN}}}\right)}{\left(\frac{V_{\text{PP}}}{I_{\text{OUT}}} - \text{ESR}\right) \cdot f_{\text{S}}}$$

for $V_{\text{IN}} = 2 \cdot V_{\text{OUT}}$,

$$\frac{V_{\text{OUT}}}{V_{\text{IN}}} \cdot \left(1 - \frac{V_{\text{OUT}}}{V_{\text{IN}}}\right) = \frac{1}{4}$$

and

$$C_{\text{IN(MIN)}} = \frac{1}{\left(\frac{V_{\text{PP}}}{I_{\text{OUT}}} - \text{ESR}\right) \cdot 4 \cdot f_{\text{S}}}$$

The input capacitor provides a low impedance loop for the edges of pulsed current drawn by the AAT2138. Low ESR/ESL X7R and X5R ceramic capacitors are ideal for this function due to their low ESR and ESL. To minimize stray parasitic inductance, place the capacitor as close as possible to the IC. This keeps the high frequency content of the input current localized, minimizing EMI and input voltage ripple.

The proper placement of the input capacitor (C1) can be seen in the evaluation board layout in the Layout section of this datasheet (see Figure 4).

A laboratory test set-up typically consists of two long wires running from the bench power supply to the eval-

uation board input voltage pins. The inductance of these wires, along with the low-ESR ceramic input capacitor, can create a high Q network that may affect converter performance. This problem often becomes apparent in the form of excessive ringing in the output voltage during load transients. Errors in the loop phase and gain measurements can also result.

Feedback Resistor Selection

The output voltage on the AAT2138 is adjustable with external resistors R1 and R2. To limit the bias current required for the external feedback resistor string while maintaining good noise immunity, the minimum suggested value for R2 is 59k Ω . Although a larger value will further reduce quiescent current, it will also increase the impedance of the feedback node, making it more sensitive to external noise and interference. The maximum value of R1 should be below 1M Ω to keep reference voltage normal and avoid noise coupling.

The external resistor R1, combined with an external capacitor up to 22pF feed-forward capacitor (C4 in Figure 3), delivers enhanced transient response for extreme pulsed load applications and reduces ripple in light load conditions. The addition of the feed forward capacitor typically requires a larger output capacitor C31-C32 for stability. The external resistors set the output voltage according to the following equation:

$$R1 = \left(\frac{V_{\text{OUT}}}{V_{\text{REF}}} - 1\right) \cdot R2 = \left(\frac{V_{\text{OUT}}}{0.6\text{V}} - 1\right) \cdot R2$$

Table 2 shows the standard 1% metal film resistor examples for different step-down output voltages

V_{OUT} (V)	R2 = 59k Ω , R1 (k Ω)
3.3	267
3.4	274
3.6	294
3.8	316

Table 2: Resistor Selections for Different Output Voltage Settings.

AAT2138

High Current Step-Down Converter with High-Precision Programmable Current Limited Load Switch

Printed Circuit Board Layout Recommendations

For best performance of the AAT2138, the following guidelines should be followed when designing the PCB layout:

1. Reliably solder the exposed pad (EP) to the GND plane. A GND pad below EP is strongly recommended.
2. Keep the power traces, including the GND trace, the SW trace and the SYSIN, REGIN short, direct and wide to allow large current flow. Keep the L connection to the SW pins as short as possible. Do not put any signal lines under the inductor.
3. Connect the input capacitors (C1 and C21) as close as possible between SYSIN and REGIN and GND to get good power filtering.

4. Connect the input capacitor C23 as close as possible between REGIN and AGND to get good power filtering and load regulation.
5. Keep the switching node, SW away from the sensitive FB node.
6. Separate the feedback trace from any power trace and connect as close as possible to the load point. Sensing along a high-current load trace will degrade DC load regulation. Place external feedback resistors as close as possible to the FB pin to minimize the length of the high impedance feedback trace.
7. Minimize the resistance of the trace from the load return to GND. This will help minimize any error in DC regulation due to differences in the potential of the internal signal ground and the power ground.

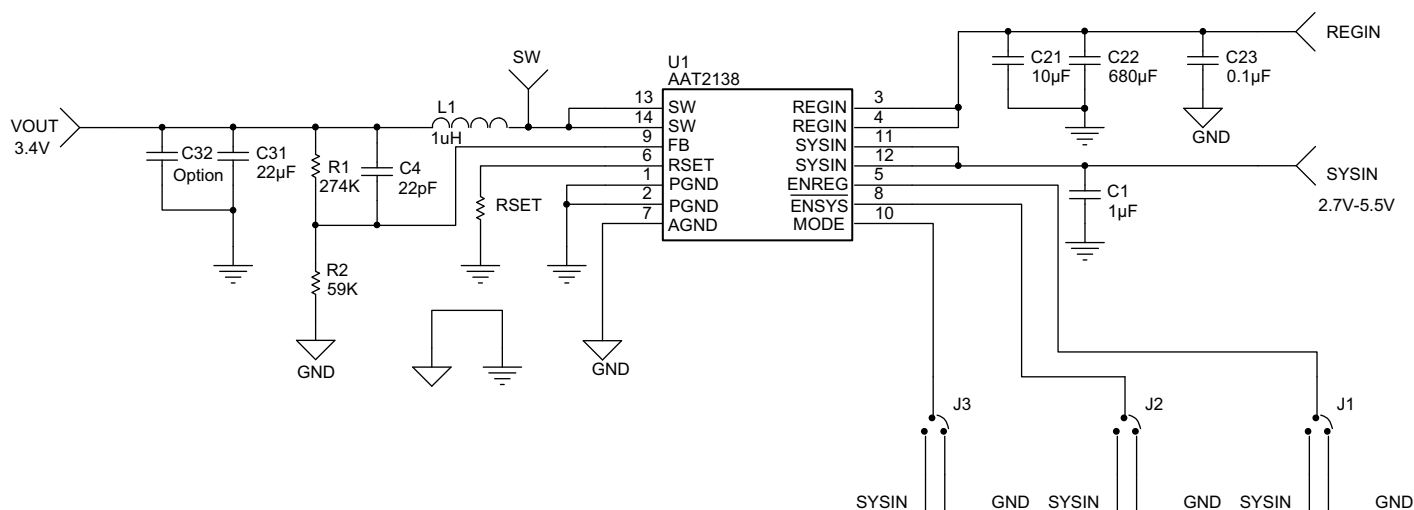
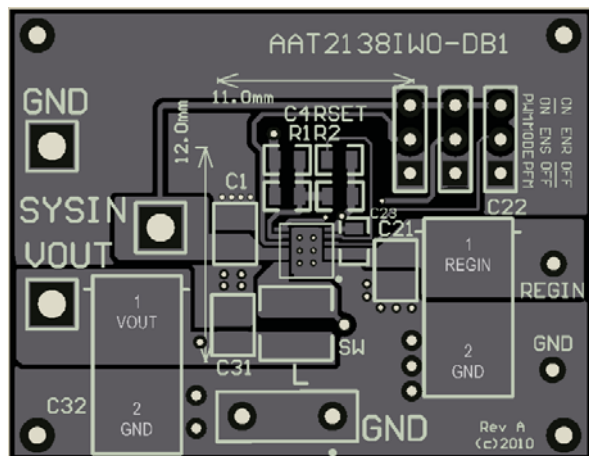

Figure 3. AAT2138 Evaluation Board Schematic.

AAT2138

High Current Step-Down Converter with High-Precision Programmable Current Limited Load Switch



(a) Top Layer

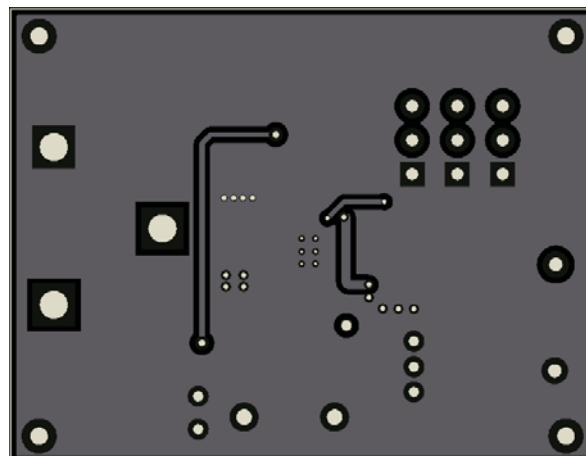

(b) Bottom Layer

Figure 4. AAT2138 Evaluation Board Layout

Manufacturer	Part Number	Inductance (μH)	Max DC Current (A)	DCR ($\text{m}\Omega$)	Size (mm) LxWxH	Type
Samsung	CIG22H1R0MNE	1	3.3	83	2x2.5x1.2	Shielded
Murata	LQH44PN1R0NPO	1	2.95	30	4x4x1.65	Shielded

Table 3: Recommended Inductor Selection

Manufacturer	Part Number	Value (μF)	Voltage (V)	Temperature Range	Case Size
Murata	GRM188R71H104KA93D	0.1	50	X7R	0603
	GRM21BR71E105KA99L	1	25	X7R	0805
	GRM21BR61C106KE15L	10	16	X5R	0805
	GRM21BR60J226ME39	22	6.3	X5R	0805
	GRM0335C1H220GD01D	22pF	50	COJ	0603
KEMET	T495D687M006ZTE150	680	6.3	X5R	7343

Table 4: Recommended Capacitor Selection.

Component	Part Number	Description	Manufacturer
U1	AAT2138IWO-0.6	High Current Step-Down Converter with Adjustable Current Limit Load Switch	Skyworks
C1	GRM21BR71E105KA99L	Cap Ceramic 1uF 0805 X7R 25V 10%	Murata
C21	GRM21BR61C106KE15L	Cap Ceramic 10uF 0805 X5R 16V 10%	
C23	GRM21BR71E105KA99L	Cap Ceramic 0.1uF 0603 X7R 50V 10%	
C31	GRM21BR60J226ME39	Cap Ceramic 22uF 0805 X5R 6.3V 10%	
C4	GRM0335C1H220GD01D	Cap Ceramic 22pF 0603 COJ 50V 10%	
C22	T495D687M006ZTE150	Cap 680uF 7343 X5R 6.3V 20%	KEMET
R1	RC0603FR-07274KL	Res 274K Ω 1/10W 1% 0603 SMD	Yageo
R2	RC0603FR-0759KL	Res 59K Ω 1/10W 1% 0603 SMD	
RSET	RC0603FR-076K34L	Res 6.34K Ω 1/10W 1% 0603 SMD	
L	CIG22H1R0MNE	Power Inductor 1uH 3.3A 83m Ω SMD	Samsung

Table 5: Evaluation Board BOM List

AAT2138

High Current Step-Down Converter with High-Precision Programmable Current Limited Load Switch

Ordering Information

Output Voltage	Package	Marking ¹	Part Number (Tape and Reel)
Adjustable $\geq 0.6V$	TDFN33-14	S6XY	AAT2138IWO-0.6-T1²

 Skyworks Green™ products are compliant with all applicable legislation and are halogen-free. For additional information, refer to *Skyworks Definition of Green™*, document number SQ04-0074.

Package Information

TDFN33-14³

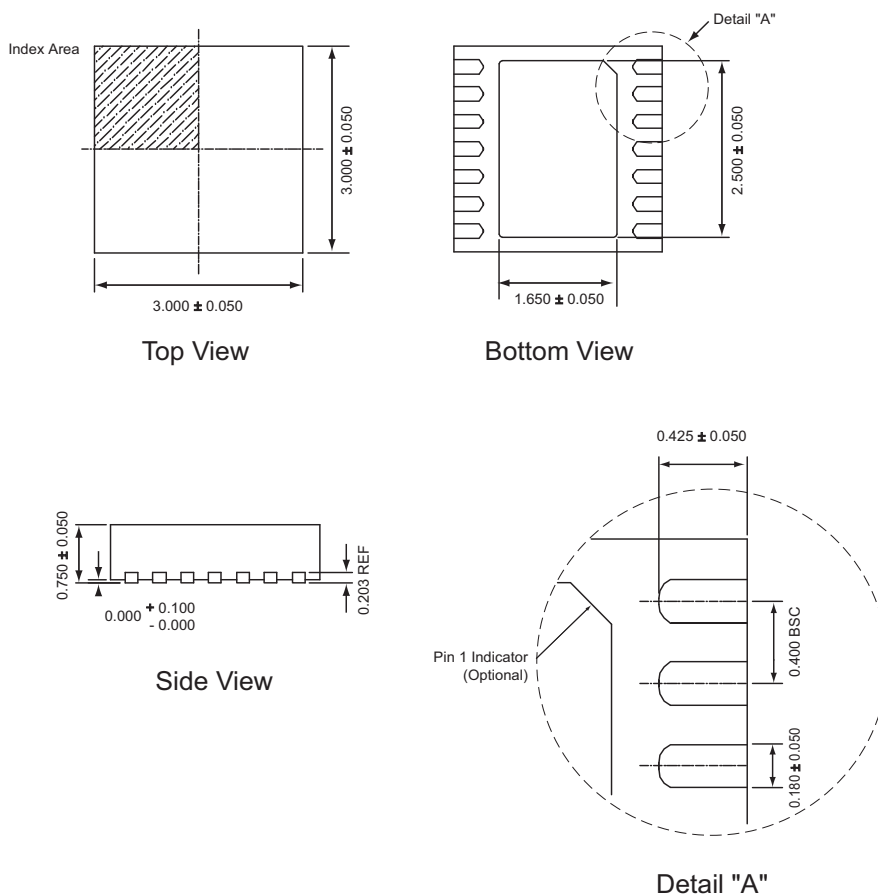

All dimensions in millimeters.

1. XYY = assembly and date code.
 2. Sample stock is generally held on part numbers listed in **BOLD**.
 3. The leadless package family, which includes QFN, TQFN, DFN, TDFN and STDFN, has exposed copper (unplated) at the end of the lead terminals due to the manufacturing process. A solder fillet at the exposed copper edge cannot be guaranteed and is not required to ensure a proper bottom solder connection.

***High Current Step-Down Converter
with High-Precision Programmable Current Limited Load Switch***

Copyright © 2012, 2013 Skyworks Solutions, Inc. All Rights Reserved.

Information in this document is provided in connection with Skyworks Solutions, Inc. ("Skyworks") products or services. These materials, including the information contained herein, are provided by Skyworks as a service to its customers and may be used for informational purposes only by the customer. Skyworks assumes no responsibility for errors or omissions in these materials or the information contained herein. Skyworks may change its documentation, products, services, specifications or product descriptions at any time, without notice. Skyworks makes no commitment to update the materials or information and shall have no responsibility whatsoever for conflicts, incompatibilities, or other difficulties arising from any future changes.

No license, whether express, implied, by estoppel or otherwise, is granted to any intellectual property rights by this document. Skyworks assumes no liability for any materials, products or information provided hereunder, including the sale, distribution, reproduction or use of Skyworks products, information or materials, except as may be provided in Skyworks Terms and Conditions of Sale.

THE MATERIALS, PRODUCTS AND INFORMATION ARE PROVIDED "AS IS" WITHOUT WARRANTY OF ANY KIND, WHETHER EXPRESS, IMPLIED, STATUTORY, OR OTHERWISE, INCLUDING FITNESS FOR A PARTICULAR PURPOSE OR USE, MERCHANTABILITY, PERFORMANCE, QUALITY OR NON-INFRINGEMENT OF ANY INTELLECTUAL PROPERTY RIGHT; ALL SUCH WARRANTIES ARE HEREBY EXPRESSLY DISCLAIMED. SKYWORKS DOES NOT WARRANT THE ACCURACY OR COMPLETENESS OF THE INFORMATION, TEXT, GRAPHICS OR OTHER ITEMS CONTAINED WITHIN THESE MATERIALS. SKYWORKS SHALL NOT BE LIABLE FOR ANY DAMAGES, INCLUDING BUT NOT LIMITED TO ANY SPECIAL, INDIRECT, INCIDENTAL, STATUTORY, OR CONSEQUENTIAL DAMAGES, INCLUDING WITHOUT LIMITATION, LOST REVENUES OR LOST PROFITS THAT MAY RESULT FROM THE USE OF THE MATERIALS OR INFORMATION, WHETHER OR NOT THE RECIPIENT OF MATERIALS HAS BEEN ADVISED OF THE POSSIBILITY OF SUCH DAMAGE.

Skyworks products are not intended for use in medical, lifesaving or life-sustaining applications, or other equipment in which the failure of the Skyworks products could lead to personal injury, death, physical or environmental damage. Skyworks customers using or selling Skyworks products for use in such applications do so at their own risk and agree to fully indemnify Skyworks for any damages resulting from such improper use or sale.

Customers are responsible for their products and applications using Skyworks products, which may deviate from published specifications as a result of design defects, errors, or operation of products outside of published parameters or design specifications. Customers should include design and operating safeguards to minimize these and other risks. Skyworks assumes no liability for applications assistance, customer product design, or damage to any equipment resulting from the use of Skyworks products outside of stated published specifications or parameters.

Skyworks, the Skyworks symbol, and "Breakthrough Simplicity" are trademarks or registered trademarks of Skyworks Solutions, Inc., in the United States and other countries. Third-party brands and names are for identification purposes only, and are the property of their respective owners. Additional information, including relevant terms and conditions, posted at www.skyworksinc.com, are incorporated by reference.