

SERIES 94H Binary Coded

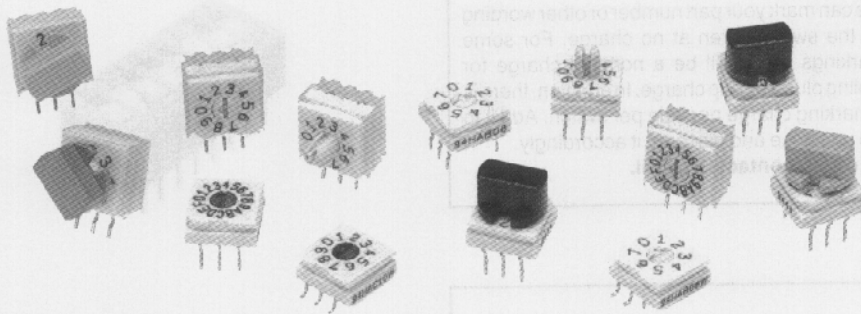

DIMENSIONS In inches (and millimeters)

Tolerances are $\pm .010$ inches unless specified otherwise.

Surface Mount Gullwing

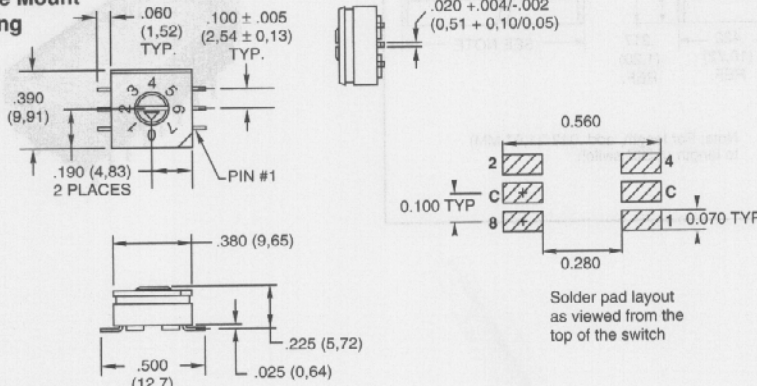

Surface Mount J-Lead

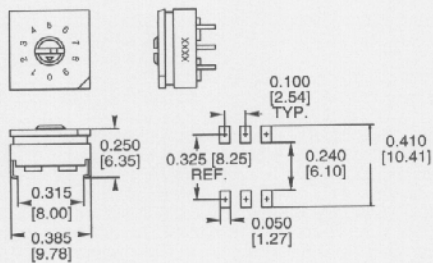

Standard Thru-Hole

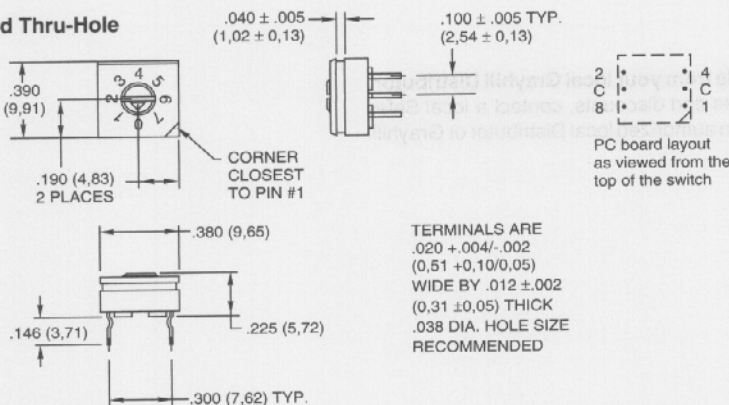

FEATURES

- Sealed Construction; No Tape Seal Required
- Surface Mount or Thru-Hole Style
- Tube or Tape and Reel Packaging
- Octal, BCD, and Hexadecimal Code
- In Standard or Complement
- Standard and Right Angle Mount
- Flush or Extended Actuators
- Gold-Plated Contacts

ACTUATOR STYLES



Octal-8 position



BCD-10 position



Hex-16 position



Figure 2
"F" style rotor

Figure 1
"A" style rotor

All actuation types are available in octal (8), binary coded decimal (10), or hexadecimal (16) codes; with either standard or complement output. Standard code outputs have natural color rotors; complements in a contrasting color.

EXTENDED ACTUATOR TYPES

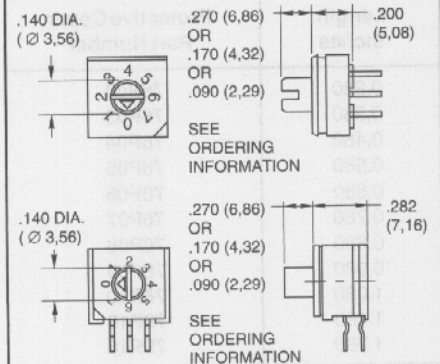
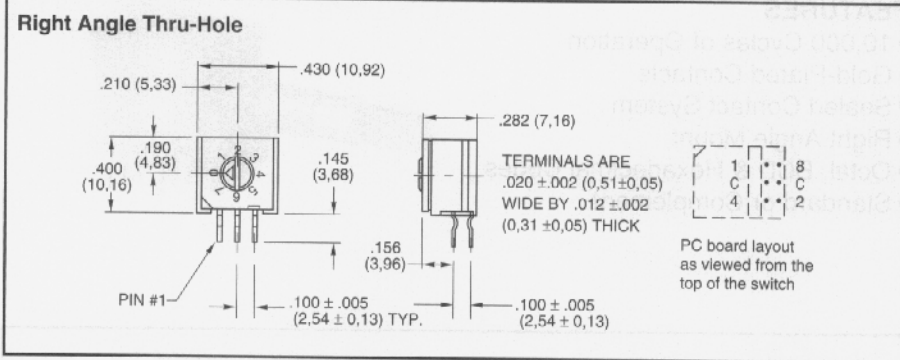
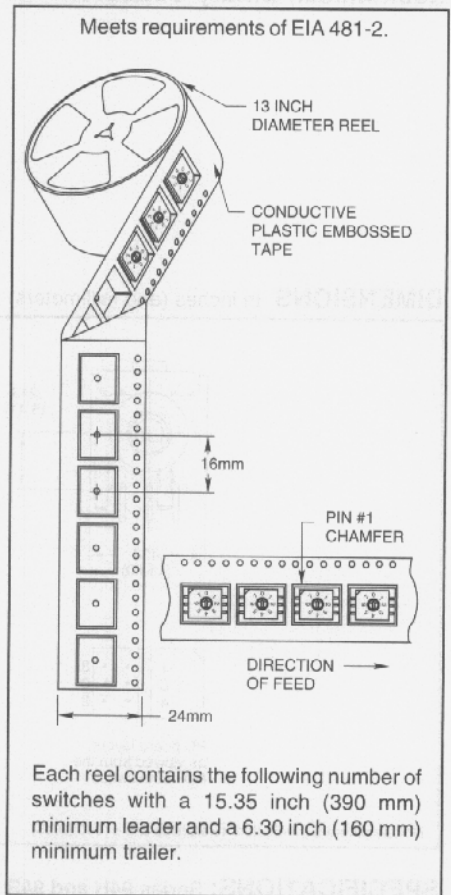

Figure 3

DIMENSIONS In inches (and millimeters)



TAPE AND REEL PACKAGING: Series 94H



ORDERING INFORMATION: Series 94H

Series
Actuator Style: A = Flush, Figure 1
B = .270, Figure 3 (see page B-21)
C = .170, Figure 3 (see page B-21)
E = .090, Figure 3 (see page B-21)
F = Flush, Figure 2

Code: B = Standard, C = Complementary

94HAB10WR

Packaging: R = Tape and Reel, (Surface Mount Only)
Blank = Tube*

Terminal Style: RA = Right Angle, Thru-Hole
J = J-Lead
W = Surface Mount
Blank = Thru-Hole

Number of Positions: 08 = Octal, 8 Position
10 = BCD, 10 Position
16 = Hex, 16 Position

* 27 Pieces per tube for surface mount and thru-hole, 24 pieces per tube for right angle switches.

SERIES 94 High Temperature Knobs: For Shaft Extensions

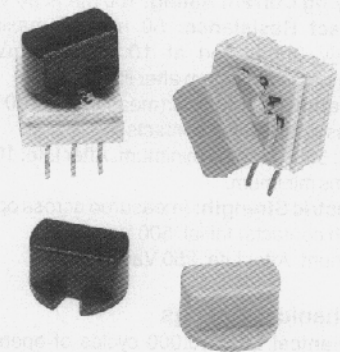
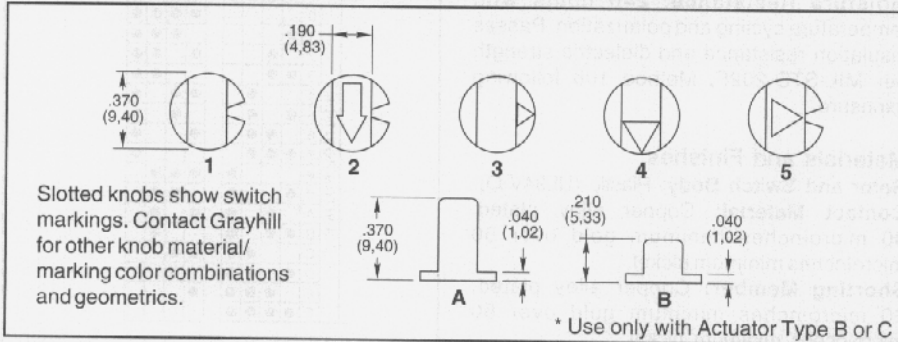

ORDERING INFORMATION: Series 94 High Temperature Knobs*

Knob Style and Height	Knob Color	Arrow Color	Part Number
1A	Gray	N/A	947706-001
5A	Gray	Black	947706-005
1B	Black	N/A	947705-001
1B	Gray	N/A	947705-012
2B	Gray	White	947705-004
3B	Gray	Black	947705-017
4B	Gray	Black	947705-018
1B	Natural	N/A	947705-009
4B	Black	White	947705-010
5B	Gray	Black	947705-019

Available from your local Grayhill Distributor. For prices and discounts, contact a local Sales Office, an authorized local Distributor or Grayhill.

*Ordered as a separate item.