Subminiature High Performance TSAIGaAs Red LED Lamps

Technical Data

HLMP-P106/P156
HLMP-Q102/Q152
HLMP-Q106/Q156

Features

- **Subminiature Flat Top Package**
Ideal for Backlighting and Light Piping Applications
- **Subminiature Dome Package**
Diffused Dome for Wide Viewing Angle
Non-diffused Dome for High Brightness
- **Wide Range of Drive Currents**
500 μ A to 50 mA
- **Ideal for Space Limited Applications**
- **Axial Leads**
- **Available with lead configurations for Surface Mount and Through Hole PC Board Mounting**

Description

Flat Top Package

The HLMP-PXXX Series flat top lamps use an untinted, non-diffused, truncated lens to provide a wide radiation pattern that is necessary for use in backlighting applications. The flat top lamps are also ideal for use as emitters in light pipe applications.

Dome Packages

The HLMP-QXXX Series dome lamps, for use as indicators, use a tinted, diffused lens to provide a wide viewing angle with high on-off contrast ratio. High brightness lamps use an untinted, nondiffused lens to provide a high luminous intensity within a narrow radiation pattern.

Lead Configurations

All of these devices are made by encapsulating LED chips on axial lead frames to form molded epoxy subminiature lamp packages. A variety of package configuration options is available. These include special surface mount lead configurations, gull wing, yoke lead, or Z-bend. Right angle lead bends at 2.54 mm (0.100 inch) and 5.08 mm (0.200 inch) center spacing are available for through hole mounting. For more information refer to Standard SMT and Through Hole Lead Bend Options for Subminiature LED Lamps data sheet.



Technology

These subminiature solid state lamps utilize a highly optimized LED material technology, transparent substrate aluminum gallium arsenide (TSAIGaAs). This LED technology has a very high luminous efficiency, capable of producing high light output over a wide range of drive currents (500 μ A to 50 mA). The color is deep red at a dominant wavelength of 644 nm deep red. TSAIGaAs is a flip-chip LED technology, die attached to the anode lead and wire bonded to the cathode lead. Available viewing angles are 75°, 35°, and 15°.

Device Selection Guide

Package Description	Viewing Angle $2 \theta_{1/2}$	Deep Red $R_d = 644 \text{ nm}$	Typical Iv $I_f = 500 \mu\text{a}$	Typical Iv $I_f = 20 \text{ mA}$	Package Outline
Domed, Diffused Tinted, Standard Current	35	HLMP-Q102		100	B
Domed, Diffused Tinted, Low Current	35	HLMP-Q152	2		B
Domed, Nondiffused Untinted, Standard Current	15	HLMP-Q106		400	B
Domed, Nondiffused Untinted, Low Current	15	HLMP-Q156	7		B
Flat Top, Nondiffused, Untinted, Standard Current	75	HLMP-P106		130	A
Flat Top, Nondiffused Untinted, Low Current	75	HLMP-P156	2		A

Ordering Information

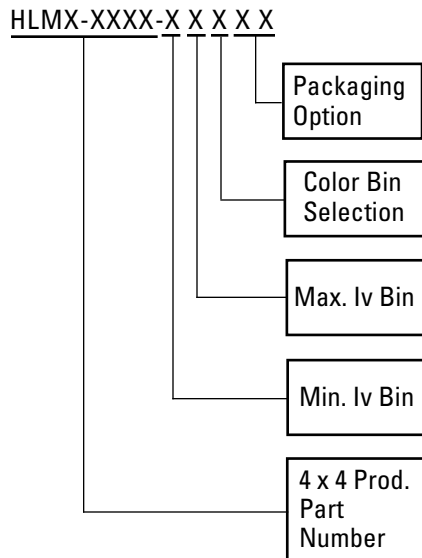

Package Dimensions

A) Flat Top Lamps

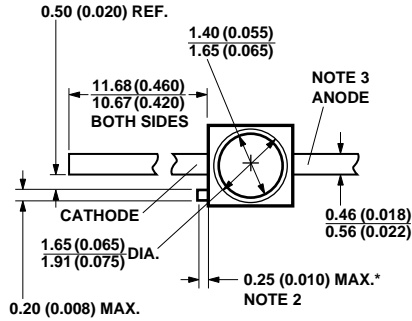

* REFER TO FIGURE 1 FOR DESIGN CONCERNS.

B) Diffused and Nondiffused Dome Lamps

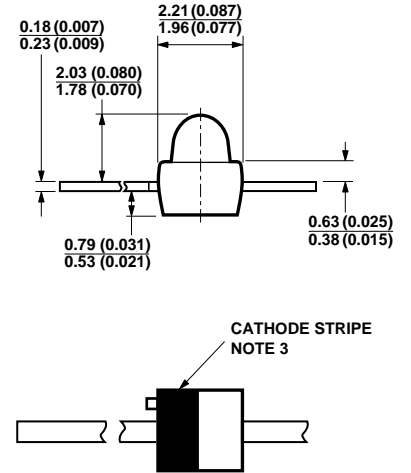
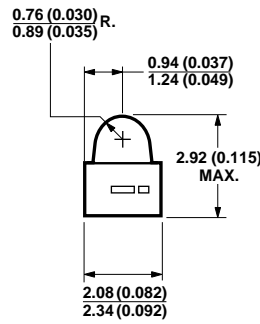
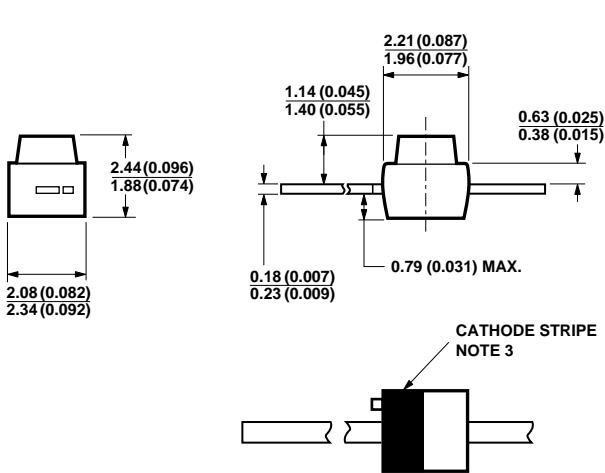
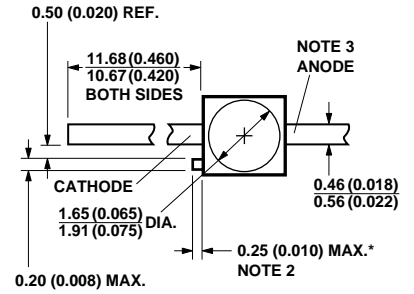

NOTES:

1. ALL DIMENSIONS ARE IN MILLIMETRES (INCHES).
2. PROTRUDING SUPPORT TAB IS CONNECTED TO ANODE LEAD.
3. LEAD POLARITY FOR THESE TS AlGaAs SUBMINIATURE LAMPS IS OPPOSITE TO THE LEAD POLARITY OF SUBMINIATURE LAMPS USING OTHER LED TECHNOLOGIES.

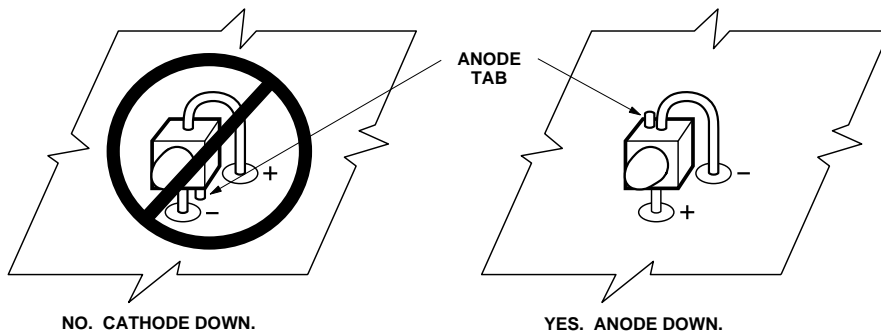

Figure 1. Proper Right Angle Mounting to a PC Board to Prevent Protruding Anode Tab from Shorting to Cathode Connection.

Absolute Maximum Ratings at $T_A = 25^\circ\text{C}$

Peak Forward Current ^[2]	300 mA
Average Forward Current (@ $I_{PEAK} = 300\text{ mA}$) ^[1,2]	30 mA
DC Forward Current ^[3]	50 mA
Power Dissipation	100 mW
Reverse Voltage ($I_R = 100\ \mu\text{A}$)	5 V
Transient Forward Current (10 μs Pulse) ^[4]	500 mA
Operating Temperature Range	-55 to +100°C
Storage Temperature Range	-55 to +100°C
LED Junction Temperature	110°C
Lead Soldering Temperature	
[1.6 mm (0.063 in.) from body]	260°C for 5 seconds
Reflow Soldering Temperatures	
Convective IR	235°C Peak, above 183°C for 90 seconds
Vapor Phase	215°C for 3 minutes

Notes:

1. Maximum I_{AVG} at $f = 1\text{ kHz}$, $DF = 10\%$.
2. Refer to Figure 7 to establish pulsed operating conditions.
3. Derate linearly as shown in Figure 6.
4. The transient peak current is the maximum non-recurring peak current the device can withstand without damaging the LED die and wire bonds. It is not recommended that the device be operated at peak currents above the Absolute Maximum Peak Forward Current.

Optical Characteristics at $T_A = 25^\circ\text{C}$

Part Number HLMP-	Luminous Intensity I_V (mcd) @ 20 mA ^[1]		Total Flux ϕ_V (mlm) @ 20 mA ^[2] Typ.	Peak Wavelength λ_{peak} (nm) Typ.	Color, Dominant Wavelength λ_d ^[3] (nm) Typ.	Viewing Angle $2\theta^{1/2}$ Degrees ^[4] Typ.	Luminous Efficacy η_V ^[5] (lm/w)
	Min.	Typ.					
Q106-R00xx	100	400	280	654	644	15	85
Q102-N00xx	25	100	-	654	644	35	85
P106-Q00xx	63	130	280	654	644	75	85

Optical Characteristics at $T_A = 25^\circ\text{C}$

Part Number (Low Current) HLMP-	Luminous Intensity I_V (mcd) @ 0.5 mA ^[1]		Total Flux ϕ_V (mlm) @ 0.5 mA ^[2] Typ.	Peak Wavelength λ_{peak} (nm) Typ.	Color, Dominant Wavelength λ_d ^[3] (nm) Typ.	Viewing Angle $2\theta^{1/2}$ Degrees ^[4] Typ.	Luminous Efficacy η_V ^[5] (lm/w)
	Min.	Typ.					
Q156-H00xx	2.5	7	10.5	654	644	15	85
Q152-G00xx	1.6	2	-	654	644	35	85
P156-EG0xx	0.63	2	10.5	654	644	75	85

Notes:

1. The luminous intensity, I_V , is measured at the mechanical axis of the lamp package. The actual peak of the spatial radiation pattern may not be aligned with this axis.
2. ϕ_V is the total luminous flux output as measured with an integrating sphere.
3. The dominant wavelength, λ_d , is derived from the CIE Chromaticity Diagram and represents the color of the device.
4. $\theta^{1/2}$ is the off-axis angle where the luminous intensity is 1/2 the peak intensity.
5. Radiant intensity, I_V , in watts/steradian, may be calculated from the equation $I_V = I_V/\eta_V$, where I_V is the luminous intensity in candelas and η_V is the luminous efficacy in lumens/watt.

Electrical Characteristics at $T_A = 25^\circ\text{C}$

Part Number HLMP-	Forward Voltage V_F (Volts) @ $I_F = 20\text{ mA}$		Reverse Breakdown V_R (Volts) @ $I_R = 100\ \mu\text{A}$		Capacitance C (pF) $V_F = 0$, $f = 1\text{ MHz}$ Typ.	Thermal Resistance $R\theta_{J-PIN}$ ($^\circ\text{C/W}$)	Speed of Response τ_s (ns) Time Constant e^{-t/τ_s} Typ.
	Typ.	Max.	Min.	Typ.			
Q106	1.9	2.4	5	20	20	170	45
Q102	1.9	2.4	5	20	20	170	45
P106	1.9	2.4	5	20	20	170	45

Electrical Characteristics at $T_A = 25^\circ\text{C}$

Part Number (Low Current) HLMP-	Forward Voltage V_F (Volts) @ $I_F = 0.5\text{ mA}$		Reverse Breakdown V_R (Volts) @ $I_R = 100\ \mu\text{A}$		Capacitance C (pF) $V_F = 0$, $f = 1\text{ MHz}$ Typ.	Thermal Resistance $R\theta_{J-PIN}$ ($^\circ\text{C/W}$)	Speed of Response τ_s (ns) Time Constant e^{-t/τ_s} Typ.
	Typ.	Max.	Min.	Typ.			
Q156	1.6	1.9	5	20	20	170	45
Q152	1.6	1.9	5	20	20	170	45
P156	1.6	1.9	5	20	20	170	45

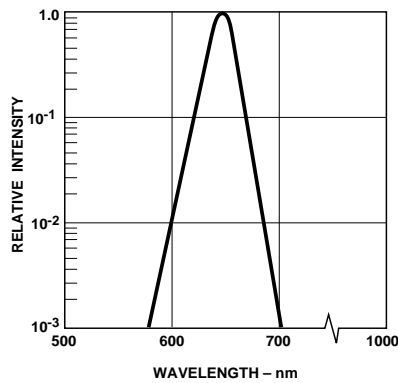

Figure 2. Relative Intensity vs. Wavelength.

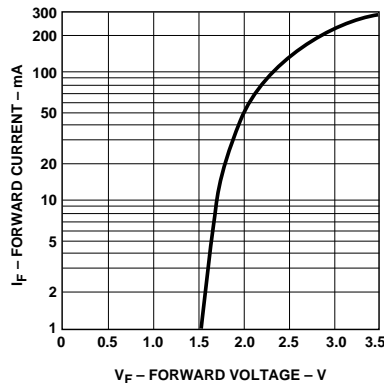

Figure 3. Forward Current vs. Forward Voltage.

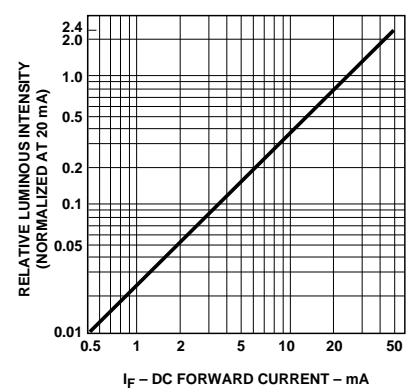

Figure 4. Relative Luminous Intensity vs. DC Forward Current.

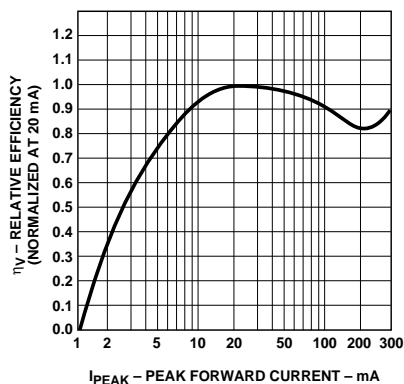

Figure 5. Relative Efficiency vs. Peak Forward Current.

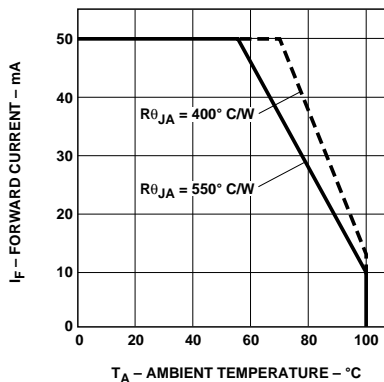

Figure 6. Maximum Forward DC Current vs. Ambient Temperature. Derating Based on $T_{JMAX} = 110^\circ\text{C}$.

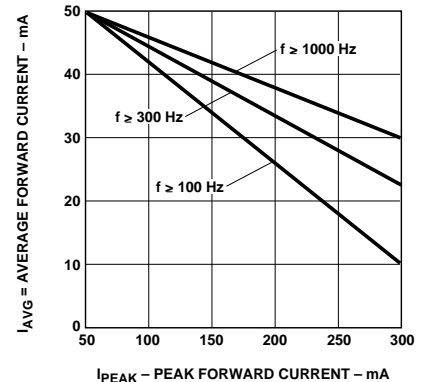

Figure 7. Maximum Average Current vs. Peak Forward Current.

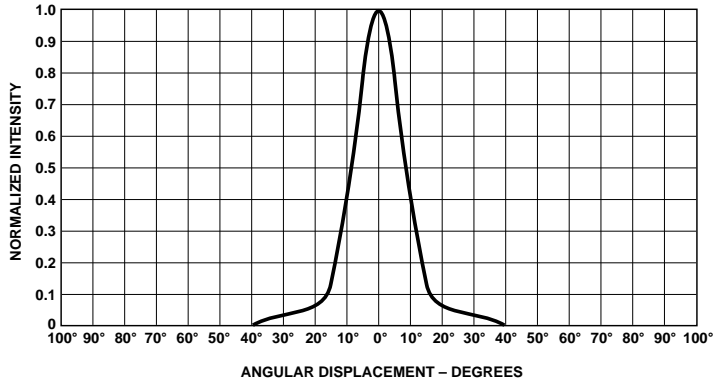

Figure 8. HLMP-Q106/-Q156.

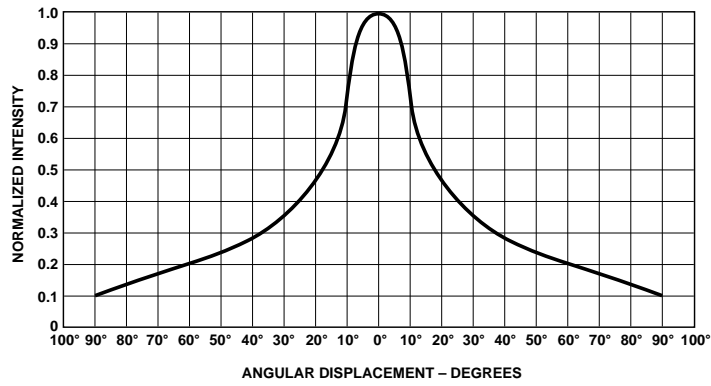

Figure 9. HLMP-Q102/-Q152

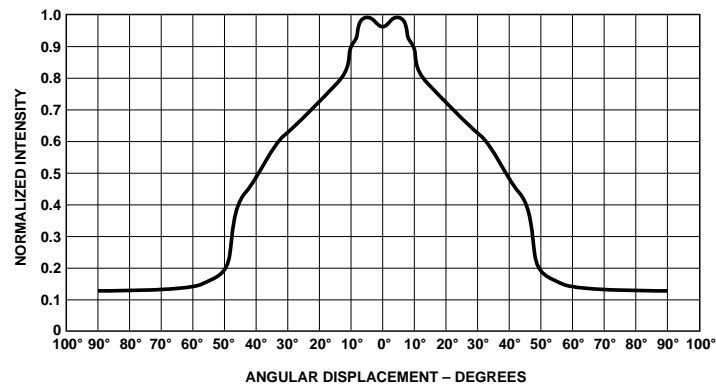

Figure 10. HLMP-P106/-P156.

Intensity Bin limits

Bin	Min.	Max.
E	0.63	1.25
F	1.00	2.00
G	1.60	3.20
H	2.50	5.00
J	4.00	8.00
K	6.30	12.50
L	10.00	20.00
M	16.00	32.00
N	25.00	50.00
P	40.00	80.00
Q	63.00	125.00
R	100.00	200.00
S	160.00	320.00
T	250.00	500.00
U	400.00	800.00
V	630.00	1250.00
W	1000.00	2000.00
X	1600.00	3200.00
Y	2500.00	5000.00

Color Bin limits

Package	Bin	Min.	Max.
Red	0	Full Distribution	

Mechanical Option

00	Straight Leads, Bulk Packaging, Quantity of 500 Parts
11	Gull Wing Leads, 12 mm Tape on 7 in. Dia. Reel, 1500 Parts per Reel
12	Gull Wing Lead, Bulk Packaging, Quantity of 500 Parts
14	Gull Wing Leads, 12 mm Tape on 13 in. Dia. Reel, 6000 Parts per Reel
21	Yoke Leads, 12 mm Tape on 7 in. Dia. Reel, 1500 Parts per Reel
22	Yoke Leads, Bulk Packaging, Quantity of 500 Parts
24	Yoke Leads, 12 mm Tape on 13 in. Dia. Reel, 6000 Parts per Reel
31	Z-Bend Leads, 12 mm Tape on 7 in. Dia. Reel, 1500 Parts per Reel
32	Z-Bend Leads, Bulk Packaging, Quantity of 500 Parts
34	Z-Bend Leads, 12 mm Tape on 13 in. Dia. Reel, 6000 Parts per Reel

Note:

All Categories are established for classification of products. Products may not be available in all categories. Please contact your local Agilent representative for further clarification/information.

www.semiconductor.agilent.com

Data subject to change.
Copyright © 2001 Agilent Technologies, Inc.
June 4, 2001
Obsoletes 5968-5431E (2/99)
5980-2437E



Product Information and Literature

- [Events](#)
- [Guided Selection](#)
- [Library](#)
- [News Releases](#)
- [Order Information](#)
- [Global Account Sites](#)
- [Partner Portal](#)
- [Product Index](#)

Hot Links

- [Product Center](#)
- [Application Notes](#)
- [Datasheets](#)
- [FAQs](#)
- [Product Notifications](#)

HLMP-P106-Q001S

Subminiature High Performance TS AlGaAs Red LED Lamps



LIFE CYCLE STATUS

AC - Active

This product is Market released and in full production

FEATURES

- Subminiature Flat Top Package
Ideal for Backlighting and Light Piping Applications
- Wide Range of Drive Currents 500 microAmps to 50 mA
- Ideal for Space Limited Applications
- Axial Leads
- 2.54 mm (0.100 inch) Centre Lead Spacing
- Short Leads; 3.7 mm (0.145 in.)

DESCRIPTION

Flat Top Package

The HLMP-P106 Series flat top lamps use an untinted, non-diffused, truncated lens to provide a wide radiation pattern that is necessary for use in backlighting applications. The flat top lamps are also ideal for use as emitters in light pipe applications.

Lead Configurations

All of these devices are made by encapsulating LED chips on axial lead frames to form molded epoxy subminiature lamp packages. For more information refer to Standard SMT and Through Hole Lead Bend Options for Subminiature LED Lamps data sheet.

Technology

These subminiature solid state lamps utilize a highly optimized LED material technology, transparent substrate aluminum gallium arsenide (TS AlGaAs). This LED technology has a very high luminous efficiency, capable of producing high light output over a wide range of drive currents (500 micro-Amps to 50 mA). The color is deep red at a dominant wavelength of 644 nm deep red. TS AlGaAs is a flip-chip LED technology, die attached to the anode lead and wire bonded to the cathode lead.

 [Add to my links](#)
 [Keep me updated](#)
 [Help downloading files](#)

Application Notes		
Application Brief: AB A05 - LED thermal testing	60 KB pdf	Cli Cli
Application Brief: AB A04: LED Lamp Thermal Properties	52 KB pdf	Cli Cli
Application Brief: AB A02 - Benefits of LEDs for instrument cluster lighting	42 KB pdf	Cli Cli
Application Brief: AB I-011 - Full color LCD backlighting with LEDs	32 KB pdf	Cli Cli
Application Brief: AB D-007 - Solutions for common LED design errors in segmented display and multi-indicator applications	39 KB pdf	Cli Cli
Application Brief: AB I-012 - Temperature compensation circuit for constant LED intensity	35 KB pdf	Cli Cli
Application Note: AN 1027: Soldering LED Components	470 KB pdf	Cli Cli
Application Note: AN 1005 - Operational considerations for LED lamps and display devices	62 KB pdf	Cli Cli
Application Note: AN 1100 - Selecting LED lamps for automotive interior applications	163 KB pdf	Cli Cli
Data Sheets & Technical Specifications		
Datasheet: HLMP-P1x6/Q1x2/Q1x6 - Subminiature High Performance TS AlGaAs LED Lamps	259 KB pdf	Cli Cli
Options Datasheet: Option 11,12,21,22,31,32,1L,1S,2L,2S - Standard SMT and Through Hole Lead Bend Options for Subminiature LED Lamps	221 KB pdf	Cli Cli
Reliability Materials		
Reliability Data: HLMP-Pxxx/Qxxx/6xxx/70xx - Subminiature Lamps Reliability Data	47 KB pdf	Cli Cli



Product Information and Literature

- [Events](#)
- [Guided Selection](#)
- [Library](#)
- [News Releases](#)
- [Order Information](#)
- [Global Account Sites](#)
- [Partner Portal](#)
- [Product Index](#)

Hot Links

- [Product Center](#)
- [Application Notes](#)
- [Datasheets](#)
- [FAQs](#)
- [Product Notifications](#)

HLMP-Q106-R001S

Subminiature High Performance TS AlGaAs Red LED Lamps



LIFE CYCLE STATUS

AC - Active

This product is Market released and in full production

FEATURES

- Subminiature Dome Package
Non-diffused Dome for High Brightness
- Wide Range of Drive Currents 500 microAmps to 50 mA
- Ideal for Space Limited Applications
- Axial Leads
- 2.54 mm (0.100 inch) Centre Lead Spacing
- Short Leads; 3.7 mm (0.145 in.)

DESCRIPTION

Dome Packages

The HLMP-Q106 Series dome lamps, for use as indicators, use an untinted, nondiffused lens to provide a high luminous intensity within a narrow radiation pattern.

Lead Configurations

All of these devices are made by encapsulating LED chips on axial lead frames to form molded epoxy subminiature lamp packages. For more information refer to Standard SMT and Through Hole Lead Bend Options for Subminiature LED Lamps data sheet.

Technology

These subminiature solid state lamps utilize a highly optimized LED material technology, transparent substrate aluminum gallium arsenide (TS AlGaAs). This LED technology has a very high luminous efficiency, capable of producing high light output over a wide range of drive currents (500 mA to 50 mA). The color is deep red at a dominant wavelength of 644 nm deep red. TS AlGaAs is a flip-chip LED technology, die attached to the anode lead and wire bonded to the cathode lead.

 [Add to my links](#)
 [Keep me updated](#)
 [Help downloading files](#)

Application Notes		
Application Brief: AB A05 - LED thermal testing	60 KB pdf	Cli Cli
Application Brief: AB A04: LED Lamp Thermal Properties	52 KB pdf	Cli Cli
Application Brief: AB A02 - Benefits of LEDs for instrument cluster lighting	42 KB pdf	Cli Cli
Application Brief: AB I-011 - Full color LCD backlighting with LEDs	32 KB pdf	Cli Cli
Application Brief: AB D-007 - Solutions for common LED design errors in segmented display and multi-indicator applications	39 KB pdf	Cli Cli
Application Brief: AB I-012 - Temperature compensation circuit for constant LED intensity	35 KB pdf	Cli Cli
Application Note: AN 1027: Soldering LED Components	470 KB pdf	Cli Cli
Application Note: AN 1005 - Operational considerations for LED lamps and display devices	62 KB pdf	Cli Cli
Application Note: AN 1100 - Selecting LED lamps for automotive interior applications	163 KB pdf	Cli Cli
Data Sheets & Technical Specifications		
Datasheet: HLMP-P1x6/Q1x2/Q1x6 - Subminiature High Performance TS AlGaAs LED Lamps	259 KB pdf	Cli Cli
Options Datasheet: Option 11,12,21,22,31,32,1L,1S,2L,2S - Standard SMT and Through Hole Lead Bend Options for Subminiature LED Lamps	221 KB pdf	Cli Cli
Reliability Materials		
Reliability Data: HLMP-Pxxx/Qxxx/6xxx/70xx - Subminiature Lamps Reliability Data	47 KB pdf	Cli Cli