



## Features

- Carbon element
- Red, orange, green, amber and white LED colors
- Center detent option
- Assortment of resistance tapers
- Various travel lengths
- Various lever sizes



# PTL Series Slide Potentiometer w/LED

## Electrical Characteristics

Standard Resistance Range  
 ..... 1K ohms to 1 megohm  
 Standard Resistance Tolerance... ±20 %  
 End Resistance  
 20 mm Travel..... 10 ohms max.  
 30 mm Travel..... 20 ohms max.  
 45 mm Travel..... 20 ohms max.  
 60 mm Travel..... 30 ohms max.  
 Insulation Resistance @ 250 VDC  
 ..... 100 megohms min.  
 Dielectric Withstanding Voltage  
 ..... 300 VAC  
 Standard Taper ..... Linear, Audio  
 Power Rating - Linear  
 20 mm Travel..... 0.05 watt  
 30 mm Travel..... 0.1 watt  
 45 mm Travel..... 0.125 watt  
 60 mm Travel..... 0.2 watt  
 Power Rating - Audio  
 20 mm Travel..... 0.025 watt  
 30 mm Travel..... 0.05 watt  
 45 mm Travel..... 0.06 watt  
 60 mm Travel..... 0.1 watt  
 Slider Noise ..... 200 mV max.

## Environmental Characteristics

Operational Life ..... 15,000 cycles  
 TR Shift ..... ±15 %  
 Operating Temperature Range  
 ..... -10 °C to +55 °C  
 Resistance to Solder Heat..... ±5 %

## Mechanical Characteristics

Mechanical Travel..... Length ±0.5 mm  
 Operating Force ..... 30 gf to 250 gf  
 Center Detent Force..... 20 gf to 200 gf  
 Stop Strength ..... 5 kgf min.  
 Shaft Axial Force ..... 5 kgf min.  
 Shaft Wobble.. 2(2 x L/20) mm p-p max.  
 Soldering Condition  
 Manual ..... 300 °C ±5 °C for 3 sec.  
 Wave ..... 260 °C ±5 °C for 5 sec.  
 Wash ..... Not recommended

## Product Dimensions

### 20 mm Length of Travel

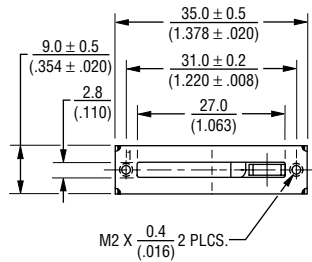

Lever Length
10.0 (.394)
15.0 (.591)
19.0 (.748)

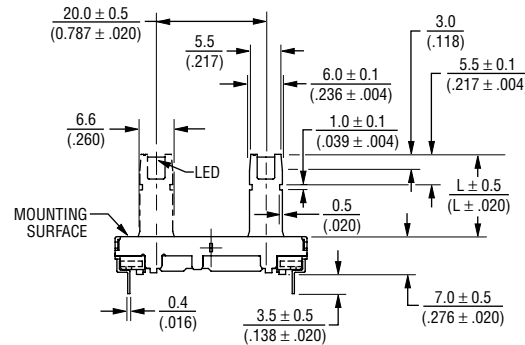

DIMENSIONS:  $\frac{\text{MM}}{\text{(INCHES)}}$



### Mounting Hole Detail

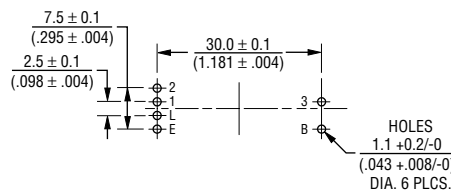

## Standard Resistance Table

Resistance (Ohms)	Resistance Code
1,000	102
2,000	202
5,000	502
10,000	103
20,000	203
50,000	503
100,000	104
200,000	204
500,000	504
1,000,000	105

## Schematic

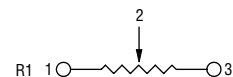

\*RoHS Directive 2002/95/EC Jan 27, 2003 including Annex.  
 Specifications are subject to change without notice.  
 Customers should verify actual device performance in their specific applications.

## Applications

- Mixing consoles
- Drum machines
- Keyboards and synthesizers
- Equalizers

# PTL Series Slide Potentiometer w/LED

# BOURNS®

## Product Dimensions

### 30 mm Length of Travel

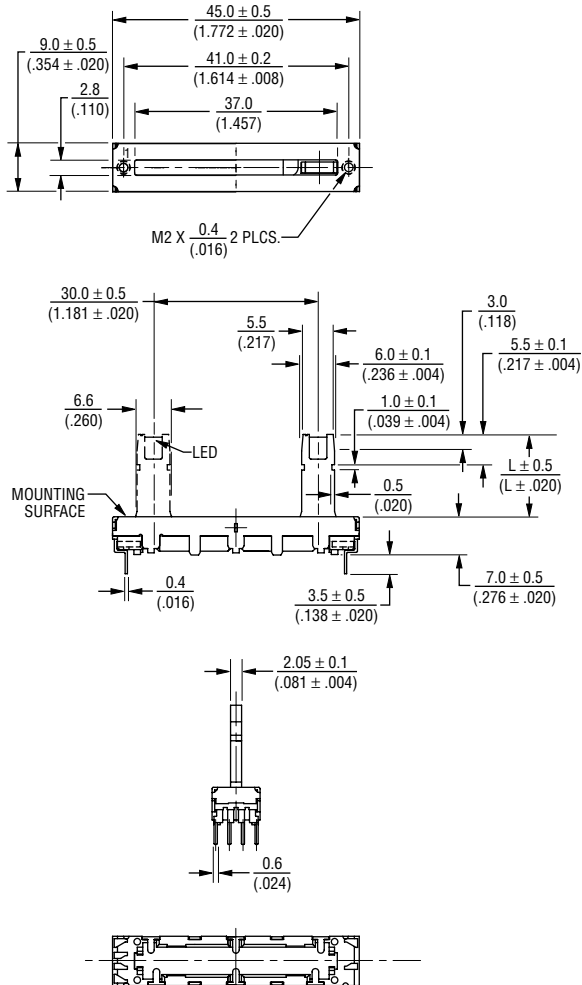

### Mounting Hole Detail

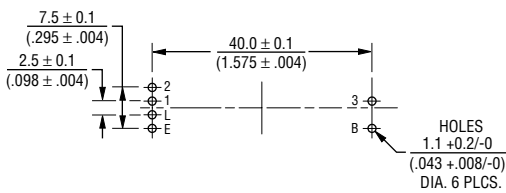

DIMENSIONS:  $\frac{\text{MM}}{\text{(INCHES)}}$

### 45 mm Length of Travel

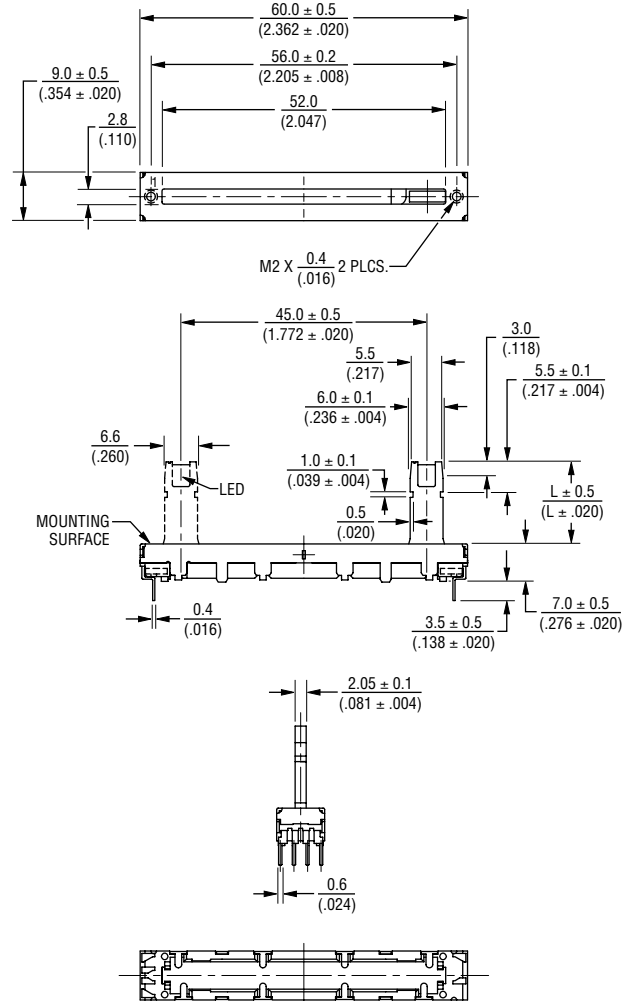

### Mounting Hole Detail

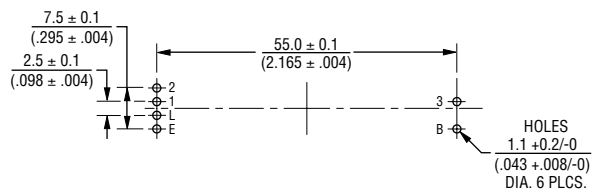

Specifications are subject to change without notice. Customers should verify actual device performance in their specific applications.



# PTL Series Slide Potentiometer w/LED

**BOURNS®**

## LED Characteristics

Emitter Color	Item	Symbol	Test Conditions	Min.	Typ.	Max.	Unit
Red	Forward Voltage	$V_F$	$I_F = 20 \text{ mA}$		2.1	2.5	V
	Luminous Intensity	$I_V$		0.3	0.6		mcd
	Peak Emission Wavelength	$\lambda_p$			660		nm
	Dominant Wavelength	$\lambda_d$			643		nm
	Spectral Line Half Width	$\Delta\lambda$			20		nm
Orange	Forward Voltage	$V_F$	$I_F = 20 \text{ mA}$		2.2	2.5	V
	Luminous Intensity	$I_V$		1.5	3.0		mcd
	Peak Emission Wavelength	$\lambda_p$			610		nm
	Dominant Wavelength	$\lambda_d$			605		nm
	Spectral Line Half Width	$\Delta\lambda$			35		nm
Green	Forward Voltage	$V_F$	$I_F = 20 \text{ mA}$		2.1	2.5	V
	Luminous Intensity	$I_V$		0.6	1.2		mcd
	Peak Emission Wavelength	$\lambda_p$			530		nm
	Dominant Wavelength	$\lambda_d$			35		nm
	Spectral Line Half Width	$\Delta\lambda$			160		nm
Amber	Forward Voltage	$V_F$	$I_F = 20 \text{ mA}$		2.1	2.6	V
	Luminous Intensity	$I_V$			5.0		mcd
	Peak Emission Wavelength	$\lambda_p$			585		nm
	Dominant Wavelength	$\lambda_d$		582	-	595	nm
	Spectral Line Half Width	$\Delta\lambda$			35		nm
White	Forward Voltage	$V_F$	$I_F = 20 \text{ mA}$		3.5	4	V
	Luminous Intensity	$I_V$			300.0		mcd
	Peak Emission Wavelength	$\lambda_p$			520		nm
	Dominant Wavelength	$\lambda_d$		460	-	470	nm
	Spectral Line Half Width	$\Delta\lambda$			35		nm

## How To Order

**PTL 30 - 10 R 0 - 103 B2**

Model Number Designator  
 PTL = Slide Potentiometer w/LED

Length of Travel  
 20 = 20 mm    45 = 45 mm  
 30 = 30 mm    60 = 60 mm

Lever Length  
 10 = 10 mm  
 15 = 15 mm  
 19 = 19 mm

LED Color  
 R = Red    A = Amber  
 O = Orange    W = White  
 G = Green

Detent Option  
 0 = No Detent  
 1 = Center Detent

Resistance Code  
 (See Standard Resistance Table)

Resistance Taper (See Taper Charts)  
 Taper Series followed by Curve Number

## Circuit

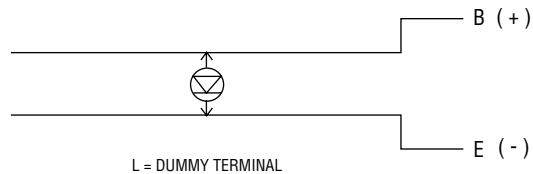

REV. 09/11

Specifications are subject to change without notice. Customers should verify actual device performance in their specific applications.