

IEC Appliance Inlet C20 with Filter, Circuit Breaker TA45 (recessed)

Standard- or Medical-Filter



C20



70° C



### Description

- Panel Mount:  
Screw-on mounting from front side
- 3 Functions:  
Appliance Inlet Protection class I, circuit breaker type TA45 2-pole, Line filter in standard and medical version
- Quick connect terminals 6.3 x 0.8 mm
- Alternative: version without line filter [EF11](#)

### Approvals

- VDE License Number: 40001520
- UL License Number: E72928

### Characteristics

- All single elements are already wired
- Line switch non-illuminated  
Illuminated version on request
- Thermal overload protection  
Optional with undervoltage- or remote trip release
- With EMC-shield
- Qualified for use in equipment according IEC/EN 60950

### References

[General Product Information](#)

### Weblinks

[Approvals](#), [RoHS](#), [CHINA-RoHS](#), [Mating Connectors](#), [e-Store](#), [SCHURTER-Stock-Check](#), [Distributor-Stock-Check](#)

### Technical Data

Ratings IEC	12 - 16A @ Ta 40 °C / 250VAC; 50Hz
Ratings UL/CSA	12 - 20A @ Ta 40 °C / 125VAC; 60Hz
Leakage Current	standard < 0.5 mA (250 V / 60Hz) medical < 5 µA (250 V / 60 Hz)
Dielectric Strength	> 1.7 kVDC between L-N > 2.7 kVDC between L/N-PE Test voltage (2 sec)
Allowable Operation Temp.	-10 °C to 55 °C
Climatic Category	10/055/21 acc. to IEC 60068-1
Degree of Protection	from front side IP 40 acc. to IEC 60529
Protection Class	Suitable for appliances with protection class 1 acc. to IEC 61140
Terminal	Quick connect terminals 6.3 x 0.8 mm
Panel Thickness s	Screw: max 8 mm Mounting screw torque max 0.5 Nm
Material: Housing	Thermoplastic, black, UL 94V-0

Appliance-Inlet/-Outlet	C20 acc. to IEC/EN 60320-1, UL 498, CSA C22.2 no. 42 (for cold conditions) pin-temperature 70 °C, 16A, Protection Class 1
Circuit Breakers	Acc. IEC/EN 60934, UL 1077, CSA 22.2 no. 235 2-pole rocker switch, illuminated or non-illuminated. Optional with undervoltage- or remote trip release Short circuit capacity Icn: at In < 3A/240VAC : 10 x In at In ≥ 3A/240VAC : 300A
Line Switch	Rocker switch 2-pole, non-illuminated or illuminated, acc. to IEC 61058-1 <a href="#">Technical details</a>
Line Filter	Standard and Medical Version, IEC 60939, IEC 60601-1, UL 1283, UL 544, EN 133 200, CSA C22.2 no. 8 <a href="#">Technical details</a>
MTBF	> 100'000h acc. to MIL-HB-217 F

## Dimensions

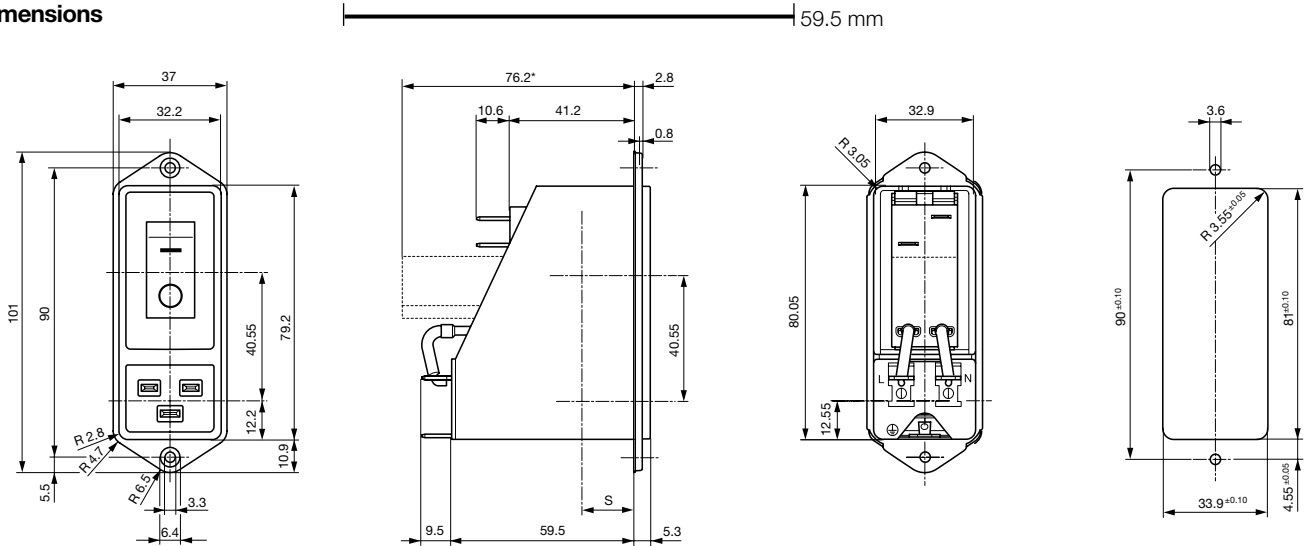

\* --- Version TA45 with undervoltage release

## Technical Data of Filter-Components

Rated Current [A]	Filter-Type	Inductances L [mH]	Capacitance CX [nF]	Capacitance CY [nF]	R [M $\Omega$ ]
12	Standard Version	2 x 0.8	100	2.2	1
16	Standard Version	2 x 0.6	100	2.2	1
20	Standard Version	2 x 0.3	100	2.2	1
12	Medical Version (M5)	2 x 0.8	100	-	1
16	Medical Version (M5)	2 x 0.6	100	-	1
20	Medical Version (M5)	2 x 0.3	100	-	1

## Diagrams

Standard version

Medical version

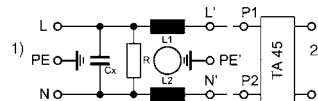
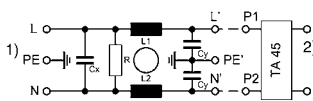

1) Line  
2) Load

1) Line  
2) Load

## Attenuation Loss

--- differential mode \_\_\_\_ common mode

Standard version

12 A

16 A

20 A

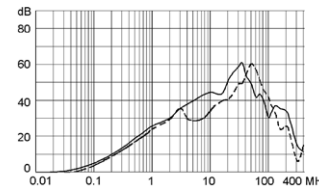
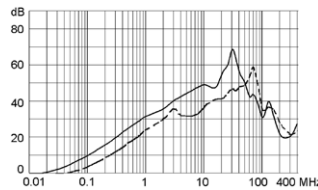
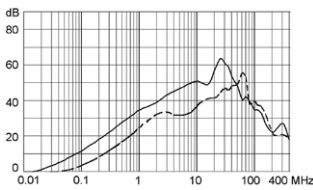

Medical version (M5)

12 A

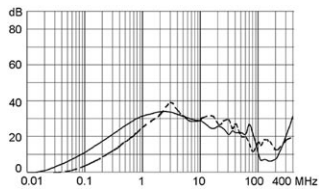

16 A

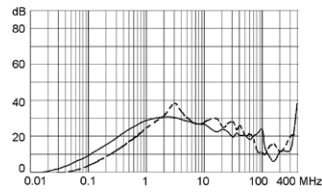

20 A

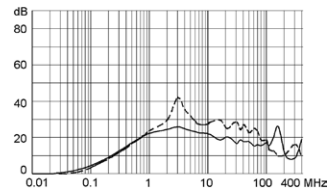

**Table 1 Selection for type TA45**

Order example



- Line switch
- 2-pole, rocker actuated
- Quick connect terminal
- Other types on request

ABT W F 150 C0

**Diagram**

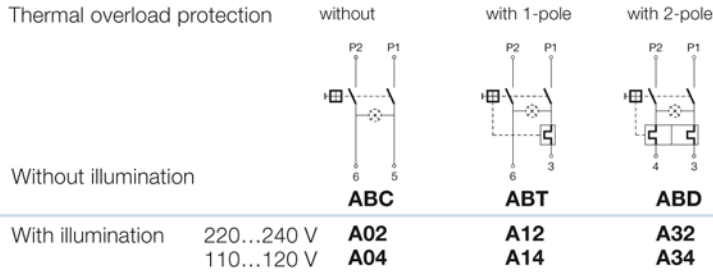

**Colours**

Switch front	Rocker	
<b>W</b> black	white	—
<b>B</b> black	black	—
<b>6</b> black	—	orange transp.

**Rocker legend**

Surface	Illustration	Colour of print	Surface	Illustration	Colour of print
<b>F</b> embossed	— ○		<b>M</b> printed	— ○	black
<b>H</b> printed	ON OFF	white	<b>P</b> printed	I ○	white
<b>K</b> printed	ON OFF	black	<b>R</b> printed	I ○	black
<b>L</b> printed	— ○	white			

Position of the rocker legend  
e.g F

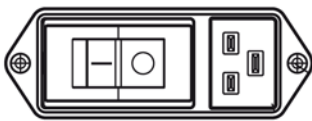

**Rated current:**

- Without thermal overload protection: code C00 }  $I_n = 20\text{ A}$
- With thermal overload protection: rated current  $I_n$  (A)

$I_n$	Code	$I_n$	Code	$I_n$	Code	$I_n$	Code
10,0	<b>100</b>	13,0	<b>130</b>	16,0	<b>160</b>	19,0	<b>190</b>
11,0	<b>110</b>	14,0	<b>140</b>	17,0	<b>170</b>	20,0	<b>200</b>
12,0	<b>120</b>	15,0	<b>150</b>	18,0	<b>180</b>		

Other rated currents on request

**Without release: code C0**

**Undervoltage release**

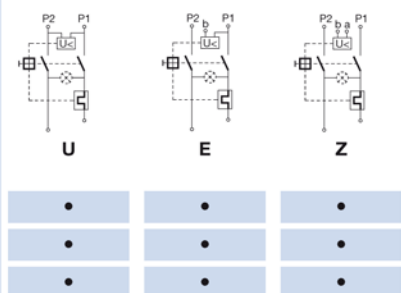

**Remote trip release**

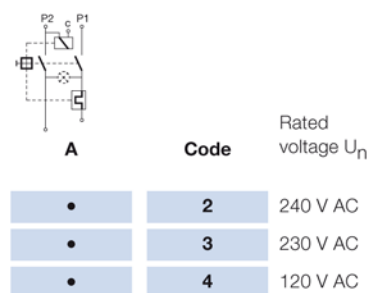

Packaging unit 16 Pcs

Accessories

Description

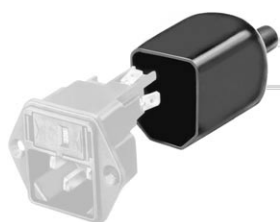

Assorted Covers  
Rear Cover

0859.0109



Cord retaining kits  
Cord retaining strain relief

Flat head, Z

0888.0021

Flat head, H

4700.0008

Mating Outlets/Connectors

Category / Description

[Connector Overview complete](#)



IEC Connector C19, Rewireable, Straight

0104

IEC Connector C19, Rewireable, Angled

1651

IEC Connector C19, Rewireable, Straight

1652

IEC Connector C19, Rewireable, Angled

4790

IEC Connector C19, Rewireable, Straight

4795

[Connector further types to EF12](#)

[Power Cord Overview complete](#)



Power Cord with IEC Connector C19, Straight

1654

[Power Cord further types to EF12](#)

[Power Supply or Interconnection Cord Overview complete](#)

Divers Power Supply and Interconnection Cords 16 A

Kabelverbindung/16 A

[Power Supply or Interconnection Cord further types to EF12](#)

**Technical data (continued)**  
**Circuit breaker**

Tripping characteristics  
 $I_n < 3 A$

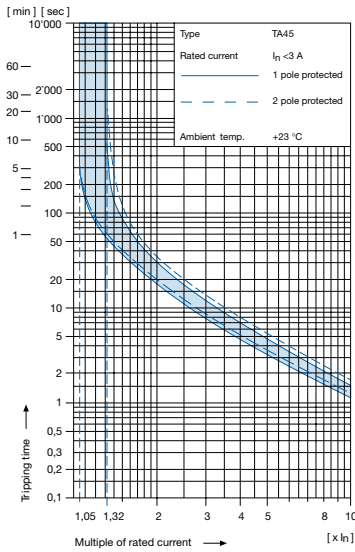

Tripping characteristics  
 $I_n \geq 3 \dots < 18 A$

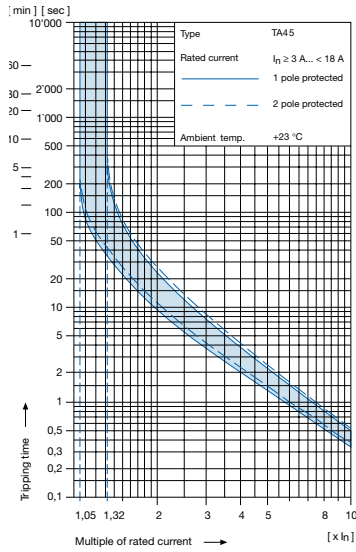

Tripping characteristics  
 $I_n \geq 18 A$

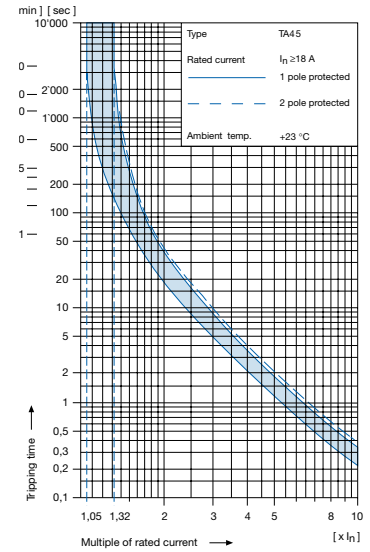

**1) Effect of ambient temperature**

The unit is calibrated for an ambient temperature of +23 °C. To determine the rated current for a lower or higher ambient temperature, use a correction factor from the table on the right side:

* Ambient temperature [°C]	Correction factor
-10	0,89
-5	0,91
0	0,92
+23	1,00
+30	1,03
+40	1,08
+55	1,16

\* Temperature must be measured at the rear of the breaker next to the terminals after equipment operating temperature has been reached.

**1) Example**

Rated current at +23 °C	6,0 A
Ambient temperature	+40 °C
Correction factor	1,08
Chosen rated current at +40 °C ambient temperature	<b>6 A x 1,08 = 6,5 A</b>

**Order code for EF12 (order example)**

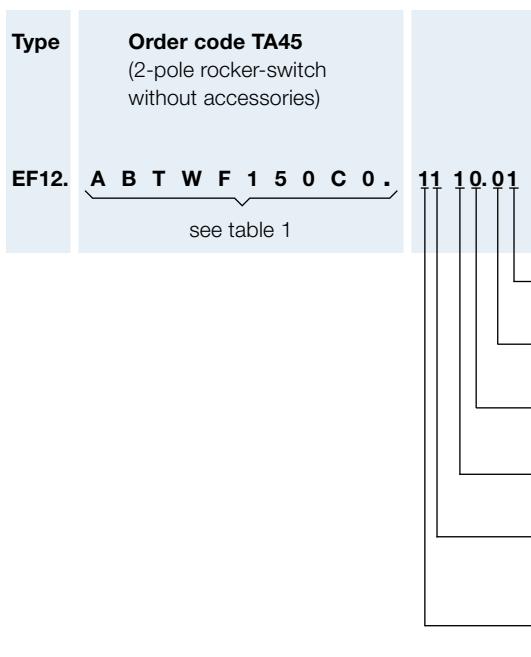

Please note that Schurter will establish an internal new part number for logistical use in addition to the order code. The format of this internal part number is, for example EF12.xxxx.1110.01

**Application note**

The rated current of the line filter must be equal or higher than the rated current of the circuit-breaker

**Other versions on request**

- Rocker switch illuminated