

0.43 Inch (10.9mm) 1 Digit NUMERIC FRAME DISPLAY

AllnGaP Red (632nm) 5082-7H50, 5082-7H51, 5082-7H53, 5082-7H56

PACKAGE DIMENSIONS

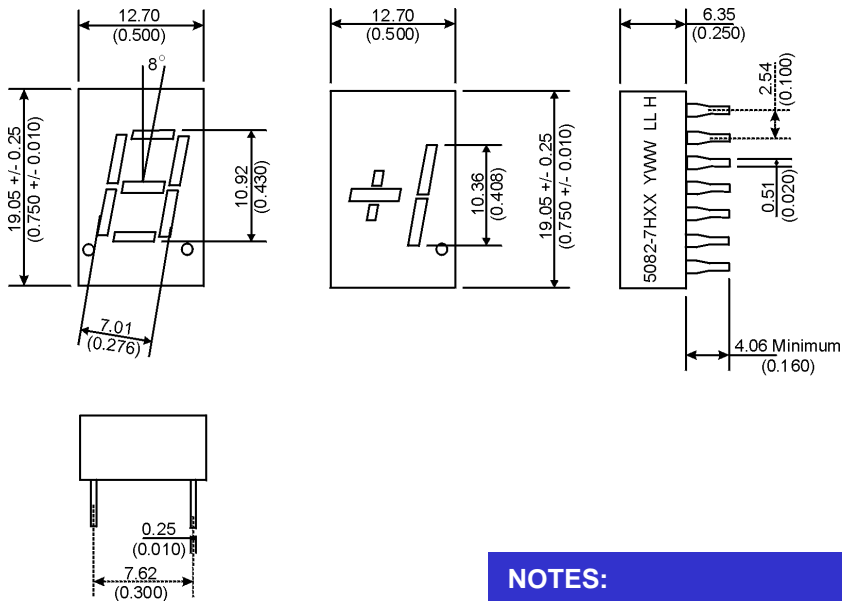

NOTES:

- Dimensions are in mm (inches)
- Tolerances are +/- 0.25 (0.010) unless otherwise stated.

FEATURES

- Bright Bold Segments
- Common Anode/Cathode
- Low Power Consumption
- Low Current Capability
- Epoxy Encapsulated Frame
- High Performance
- High Reliability

APPLICATIONS

- Appliances
- Automotive
- Instrumentation
- Process Control

MODELS AVAILABLE

Part Number	Colour	Description	Special
5082-7H50	AllnGaP 632nm	LHDP, CA; Red Face, Red Segments	Low Current Capability
5082-7H51	AllnGaP 632nm	RHDP, CA, Red Face, Red Segments	Low Current Capability
5082-7H53	AllnGaP 632nm	RHDP, CC, Red Face, Red Segments	Low Current Capability
5082-7H56	AllnGaP 632nm	RHDP, Red Face, Red Segments	Low Current Capability

(For other colour options, contact your local area Sales Manager)



0.43 Inch (10.9mm) 1 Digit NUMERIC FRAME DISPLAY

ABSOLUTE MAXIMUM RATINGS⁽¹⁾ ($T_A = 25^\circ\text{C}$, unless otherwise specified)

Part Number	5082-7HXX	
Parameter		Units
Continuous Forward Current (each segment)	25	mA
Peak Forward Current ($F = 10\text{KHz}$, $D/F = 1/10$)	100	mA
Power Dissipation (P_D)	60	mW
*Derate Linearly from 25°C	0.36	mW
Reverse Voltage per Die	5 Volts	
Operating and Storage Temperature Range	-40°C to $+85^\circ\text{C}$	
Lead soldering time (1/16 inch from standoffs)	5 seconds @ 230°C	

ELECTRO-OPTICAL CHARACTERISTICS⁽¹⁾ ($T_A = 25^\circ\text{C}$, unless otherwise specified)

Part Number	5082-7HXX		
Parameter		Units	Test Condition
Luminous intensity⁽²⁾ (I_V)			
Minimum (Standard Current)	6000	ucd	$I_F = 10\text{mA}$
Typical (Standard Current)	7800	ucd	$I_F = 10\text{mA}$
Minimum (Low Current)	510	ucd	$I_F = 2\text{mA}$
Typical (Low Current)	1000	ucd	$I_F = 2\text{mA}$
Forward Voltage (V_F)			
Typical (Standard Current)	2.05	Volts	$I_F = 10\text{mA}$
Maximum (Standard Current)	2.40	Volts	$I_F = 10\text{mA}$
Typical (Low Current)	1.80	Volts	$I_F = 2\text{mA}$
Maximum (Low Current)	2.20	Volts	$I_F = 2\text{mA}$
Peak Wavelength	632	nm	$I_F = 10\text{mA}$
Dominant Wavelength	624	nm	$I_F = 10\text{mA}$
Spectral Line 1/2 Width	20	nm	$I_F = 10\text{mA}$
Reverse B⁽³⁾.Voltage (V_R)	5	Volts	$I_R = 100\mu\text{A}$

NOTES:

- (1) Data per individual LED element
- (2) Luminous intensity (ucd) = average light output per segment
- (3) B = breakdown

0.43 Inch (10.9mm) 1 Digit NUMERIC FRAME DISPLAY

PIN ORIENTATION, SEGMENT IDENTIFICATION, AND PRODUCT MARKING

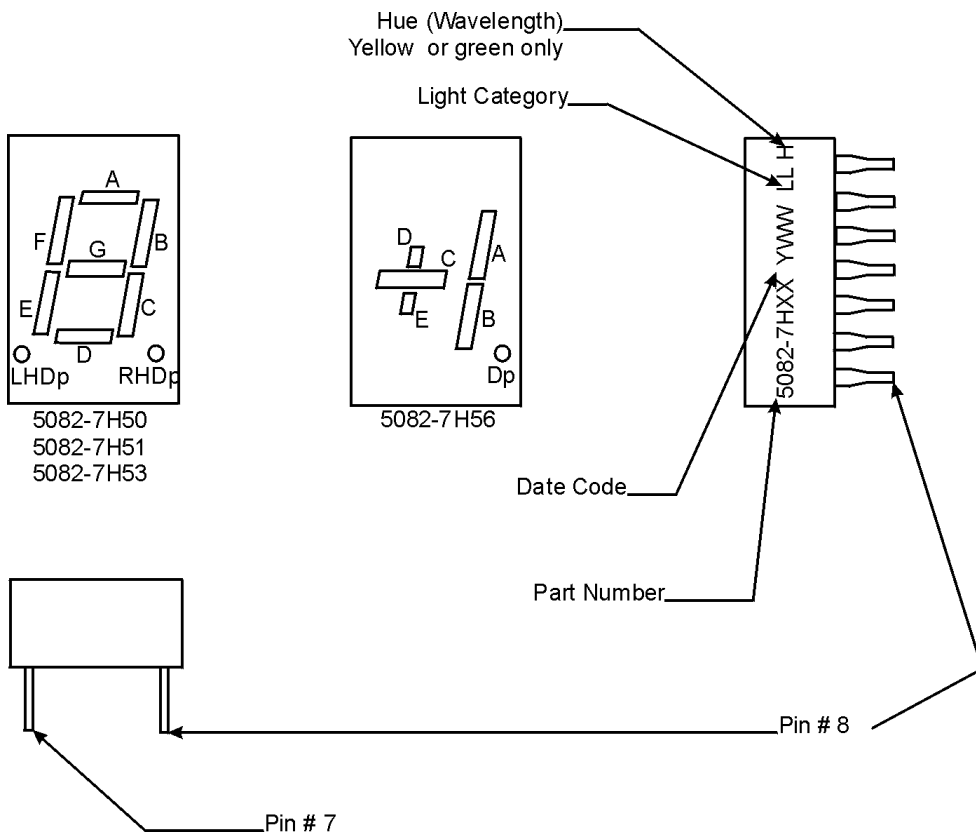

SCHEMATICS

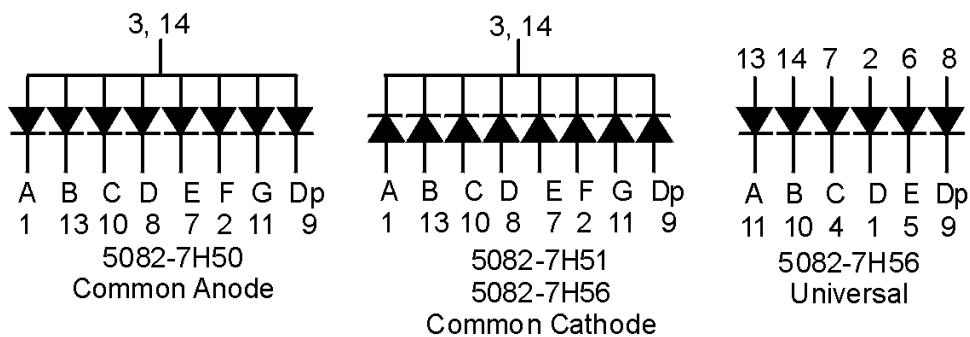

GRAPHICAL DATA AllnGaP 630nm ($T_A = 25^\circ\text{C}$, unless otherwise specified)

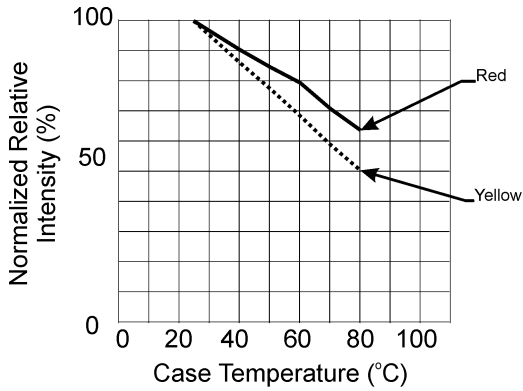

Relative Intensity vs Case Temp.

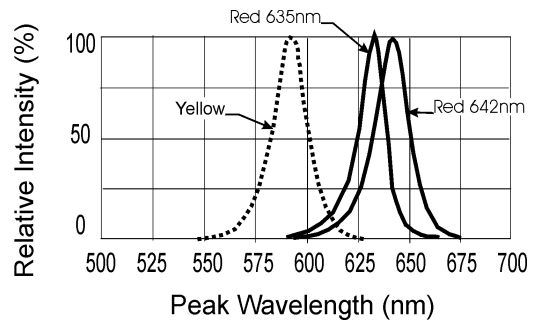

Spectral Response

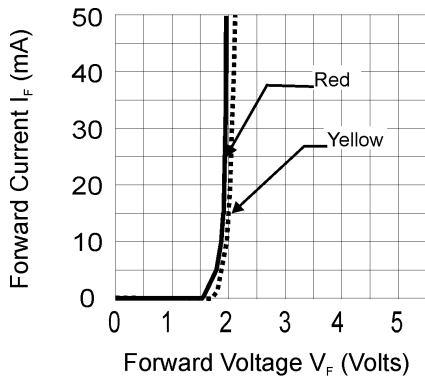

Forward Current vs Forward Voltage

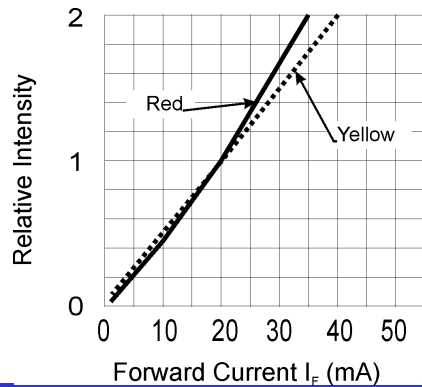

Luminous Intensity vs Duty Cycle

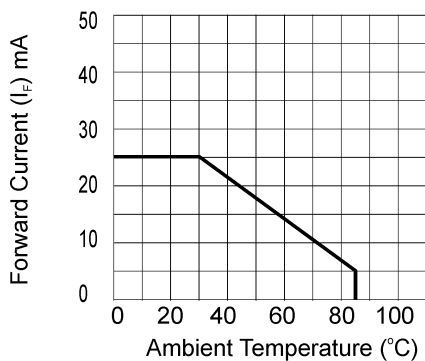

Maximum Forward Current vs Ambient Temperature

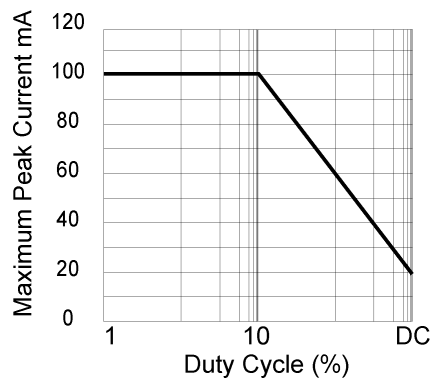

Maximum Peak Current vs Duty Cycle