

Cree® 5mm Amber Round LED

C503B-AAS/AAN-015 (15 degree minimum)

C503B-ACS/ACN-030 (30 degree minimum)

Data Sheet

Round LEDs offer superior light output for excellent readability in sunlight and dependable performance. It provides extremely stable light output over long periods of time.

These lamps are made with an advanced optical grade epoxy offering superior high temperature and high moisture resistance performance in outdoor signal and sign applications.

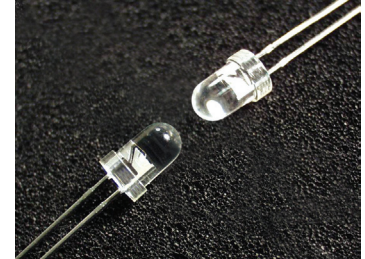

FEATURES

- Size (mm): 5
- Color and Typical Dominant Wavelength (nm): Amber (591)
- Luminous Intensity (mcd)
C503B-AAS/AAN-015 (12000 - 32900)
C503B-ACS/ACN-030 (5860 - 12000)
- Viewing angle:
C503B-AAS/AAN-015: 15 degree minimum
C503B-ACS/ACN-030: 30 degree minimum
- Lead-Free
- RoHS Compliant

APPLICATIONS

- Electronic Signs & Signals (ESS)
- Motorway Signs
- Variable Message Sign (VMS)
- Advertising Signs
- Petrol Signs
- Amusement
- Transportation
- Roadway Signs



Absolute Maximum Ratings ($T_A = 25^\circ\text{C}$)

Items	Symbol	Absolute Maximum Rating	Unit
		Amber	
Forward Current	I_F	50 ^{Note1}	mA
Peak Forward Current ^{Note2}	I_{FP}	200	mA
Reverse Voltage	V_R	5	V
Power Dissipation	P_D	130	mW
Operation Temperature	T_{opr}	-40 ~ +100	$^\circ\text{C}$
Storage Temperature	T_{stg}	-40 ~ +100	$^\circ\text{C}$
Lead Soldering Temperature	T_{sol}	Max. 260 $^\circ\text{C}$ for 3 sec. max. (3 mm from the base of the epoxy bulb)	
Electrostatic Discharge Classification (MIL-STD-883E)	ESD	Class 2	

Note:

1. For long term performance the drive currents between 10mA and 30mA are recommended. Please contact CREE sales representative for more information on recommended drive conditions.
2. Pulse width ≤ 0.1 msec, duty $\leq 1/10$.

Typical Electrical & Optical Characteristics ($T_A = 25^\circ\text{C}$)

Characteristics	Color	Symbol	Condition	Unit	Minimum	Typical	Maximum
Forward Voltage	Amber	V_F	$I_F = 20$ mA	V		2.1	2.6
Reverse Current	Amber	I_R	$V_R = 5$ V	μA			100
Dominant Wavelength	Amber	λ_D	$I_F = 20$ mA	nm	584	591	596
Luminous Intensity	C503B-AAS/AAN-015	I_V	$I_F = 20$ mA	mcd	12000	15000	
	C503B-ACS/ACN-030	I_V	$I_F = 20$ mA	mcd	5860	6000	
50% Power Angle	C503B-AAS/AAN-015	$2\theta_{1/2}$	$I_F = 20$ mA	deg	15		
	C503B-ACS/ACN-030	$2\theta_{1/2}$	$I_F = 20$ mA	deg	30		



Intensity Bin Limit ($I_f = 20 \text{ mA}$)

C503B-AAS/AAN-015 (15 degree min)

Bin Code	Min.(mcd)	Max.(mcd)
A0	12000	16800
B0	16800	23500
C0	23500	32900

C503B-ACS/ACN-030 (30 degree min)

Bin Code	Min.(mcd)	Max.(mcd)
Y0	5860	8200
Z0	8200	12000

- Tolerance of measurement of luminous intensity is $\pm 15\%$

Color Bin Limit ($I_f = 20 \text{ mA}$)

Bin Code	Min.(nm)	Max.(nm)
A2	584	587
A3	587	590
A4	590	593
A5	593	596

- Tolerance of measurement of dominant wavelength is $\pm 1 \text{ nm}$



Order Code Table*

Amber (15 degree min)

Color	Kit Number	Viewing Angle	Luminous Intensity (mcd)		Dominant Wavelength				Package	Standoff
			Min.	Max.	Color Bin	Min. (nm)	Color Bin	Max. (nm)		
Amber	C503B-AAS-CA0C0251-015	15	12000	32900	A2	584	A5	596	Bulk	Yes
Amber	C503B-AAS-CA0C0341-015	15	12000	32900	A3	587	A4	593	Bulk	Yes
Amber	C503B-AAN-CA0C0251-015	15	12000	32900	A2	584	A5	596	Bulk	No
Amber	C503B-AAN-CA0C0341-015	15	12000	32900	A3	587	A4	593	Bulk	No
Amber	C503B-AAS-CA0C0252-015	15	12000	32900	A2	584	A5	596	Ammo	Yes
Amber	C503B-AAS-CA0C0342-015	15	12000	32900	A3	587	A4	593	Ammo	Yes
Amber	C503B-AAN-CA0C0252-015	15	12000	32900	A2	584	A5	596	Ammo	No
Amber	C503B-AAN-CA0C0342-015	15	12000	32900	A3	587	A4	593	Ammo	No

Amber (30 degree min)

Color	Kit Number	Viewing Angle	Luminous Intensity (mcd)		Dominant Wavelength				Package	Standoff
			Min.	Max.	Color Bin	Min. (nm)	Color Bin	Max. (nm)		
Amber	C503B-ACS-CY0Z0251-030	30	5860	12000	A2	584	A5	596	Bulk	Yes
Amber	C503B-ACS-CY0Z0341-030	30	5860	12000	A3	587	A4	593	Bulk	Yes
Amber	C503B-ACN-CY0Z0251-030	30	5860	12000	A2	584	A5	596	Bulk	No
Amber	C503B-ACN-CY0Z0341-030	30	5860	12000	A3	587	A4	593	Bulk	No
Amber	C503B-ACS-CY0Z0252-030	30	5860	12000	A2	584	A5	596	Ammo	Yes
Amber	C503B-ACS-CY0Z0342-030	30	5860	12000	A3	587	A4	593	Ammo	Yes
Amber	C503B-ACN-CY0Z0252-030	30	5860	12000	A2	584	A5	596	Ammo	No
Amber	C503B-ACN-CY0Z0342-030	30	5860	12000	A3	587	A4	593	Ammo	No

Notes:

1. The above Kit numbers represent order codes which include multiple intensity-bin and color-bin codes. Only one intensity-bin code and one color-bin code will be shipped on each reel. Single intensity-bin code and single color-bin codes will not be orderable.
2. Please refer to the "Cree LED Lamp Reliability Test Standards" document for reliability test conditions.
3. Please refer to the "Cree LED Lamp Soldering & Handling" document for information about how to use this LED product safely.

Graphs

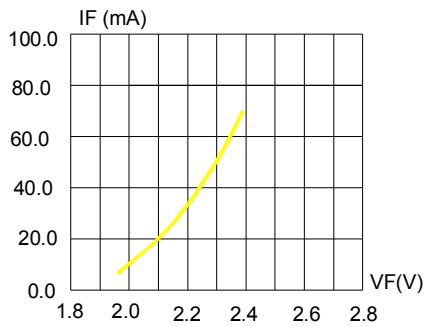

FIG.1 FORWARD CURRENT VS. FORWARD VOLTAGE.

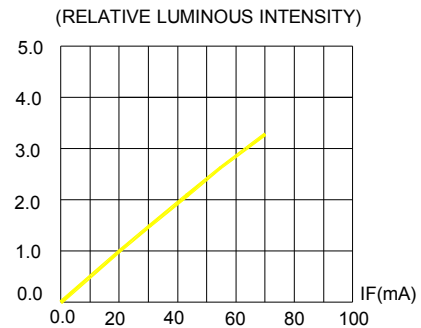

FIG.2 RELATIVE LUMINOUS INTENSITY VS. FORWARD CURRENT

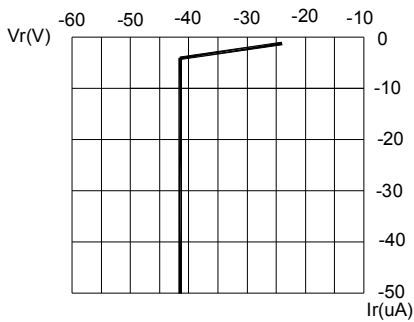

FIG.3 REVERSE CURRENT VS. REVERSE VOLTAGE.

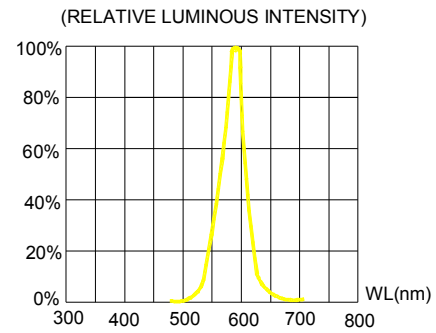

FIG.4 RELATIVE LUMINOUS INTENSITY VS. WAVELENGTH.

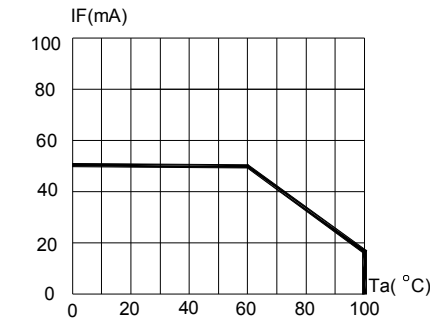
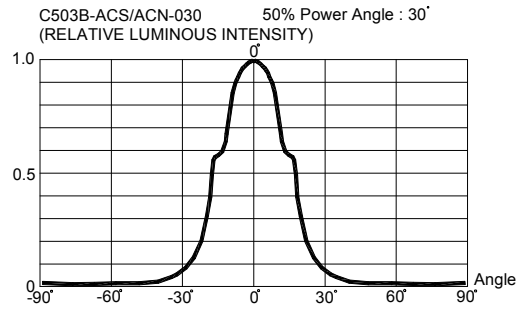
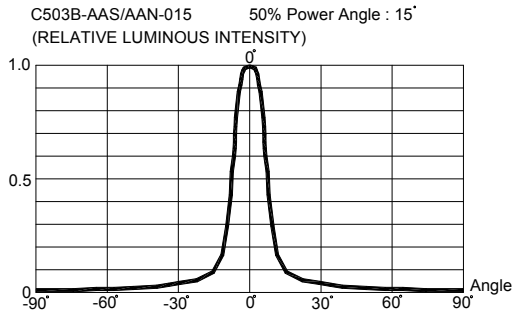

FIG.5 MAXIMUM FORWARD DC CURRENT VS AMBIENT TEMPERATURE ($T_{jmax}=110^{\circ}C$)

The above data are collected from statistical figures that do not necessarily correspond to the actual parameters of each single LED. Hence, these data will be changed without further notice.

Graphs



The above data are collected from statistical figures that do not necessarily correspond to the actual parameters of each single LED. Hence, these data will be changed without further notice.

Mechanical Dimensions

All dimensions are in mm. Tolerance is ± 0.25 mm unless otherwise noted.

An epoxy meniscus may extend about 1.5 mm down the leads.

Burr around bottom of epoxy may be 0.5 mm max.

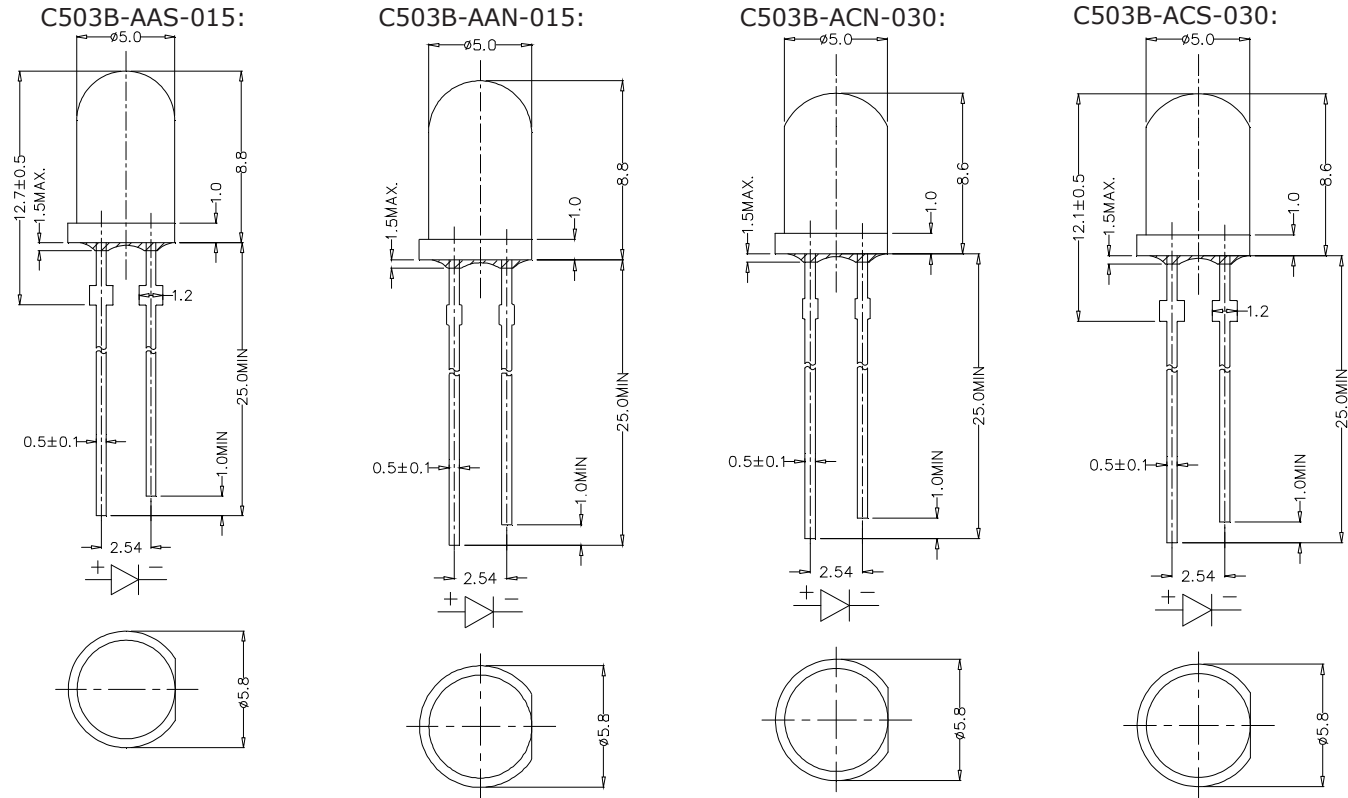

Notes

RoHS Compliance

The levels of environmentally sensitive, persistent biologically toxic (PBT), persistent organic pollutants (POP), or otherwise restricted materials in this product are below the maximum concentration values (also referred to as the threshold limits) permitted for such substances, or are used in an exempted application, in accordance with EU Directive 2002/95/EC on the restriction of the use of certain hazardous substances in electrical and electronic equipment (RoHS), as amended through April 21, 2006.

Vision Advisory Claim

Users should be cautioned not to stare at the light of this LED product. The bright light can damage the eye.



Kit Number System

Cree LED lamps are tested and sorted into performance bins. A bin is specified by ranges of color, forward voltage, and brightness. Sorted LEDs are packaged for shipping in various convenient options. Please refer to the "Cree LED Lamp Packaging Standard" document for more information about shipping and packaging options.

Cree LEDs are sold by order codes in combinations of bins called kits. Order codes are configured in the following manner:

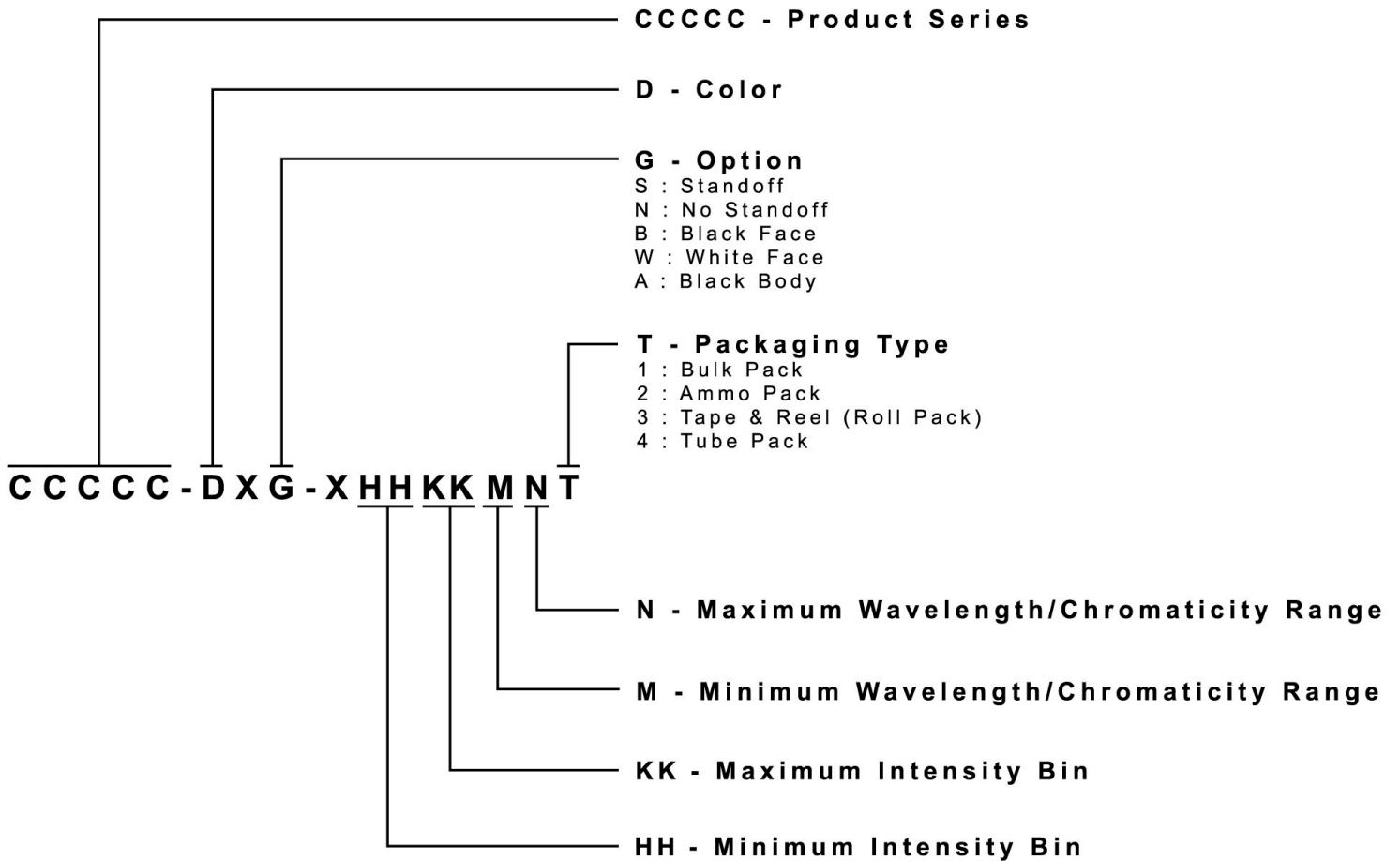

Package

Features:

- The LEDs are packed in cardboard boxes after packaging in normal or anti-electrostatic bags.
- Cardboard boxes will be used to protect the LEDs from mechanical shock during transportation.
- The boxes are not water resistant, and they must be kept away from water and moisture.
- The Bulk Pack types of packaging.
- Max 500 pcs per bulk and Max 2500 pcs per ammo.

Bulk Pack Packaging Type:

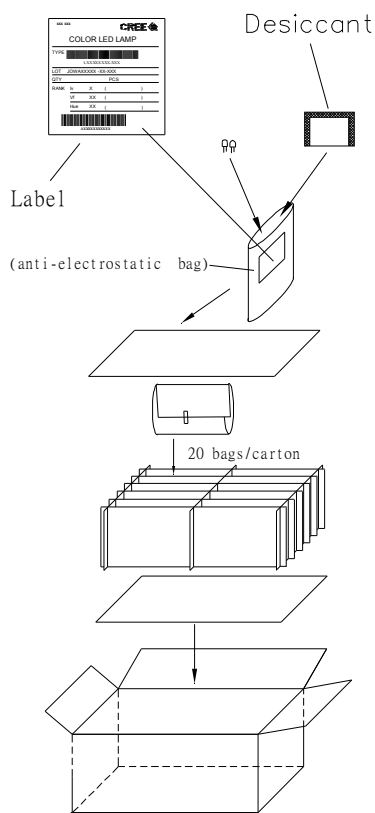

Ammo Pack Packaging Type:

