

LOC	DIST	REVISIONS			
P	LTR	DESCRIPTION	DATE	DWN	APVD
E	B				
	BA	NEW RELEASE	03MAY2010	PT	St.P

FOR FURTHER INFORMATION SEE DATA SHEET FOR
RP73 SERIES-SMD HIGH POWER PRECISION RESISTORS

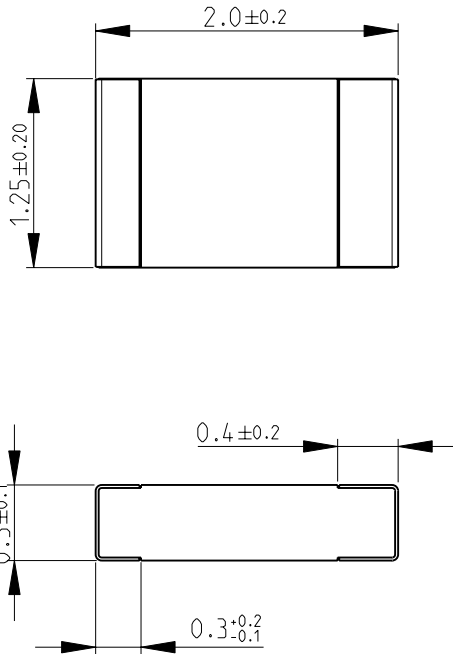

RoHS Compliant

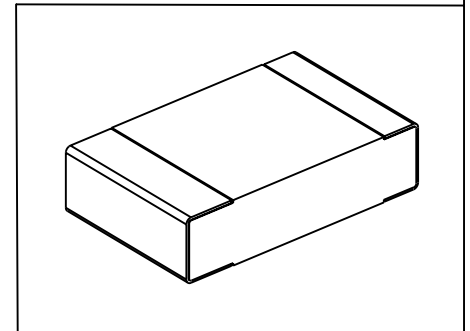

2008

RELEASED FOR PUBLICATION

THIS DRAWING IS UNPUBLISHED.

BY TYCO ELECTRONICS CORPORATION. ALL RIGHTS RESERVED.



DIMENSIONS: mm	DWN PARUSURAM.T	03MAY2010	MATERIAL	-	FINISH	-
	CHK SUBHASH.M	03MAY2010	Tyco Electronics Corporation Dorcan, Swindon, SN3 5HH			
TOLERANCES UNLESS OTHERWISE SPECIFIED:	APVD STEPHEN.P	03MAY2010				
0 PLC ±0.2	PRODUCT SPEC	-	NAME SMD HIGH POWER PRECISION RESISTORS SERIES RP73 - 2A			
1 PLC ±0.1	APPLICATION SPEC	-				
2 PLC ±-	WEIGHT	-	SIZE	A 4	CAGE CODE	00779
3 PLC ±-			DRAWING NO	C= 1625865		RESTRICTED TO
4 PLC ±-						-
ANGLES ±5°						
	CUSTOMER DRAWING		SCALE	20:1	SHEET	1 OF 1
						REV BA