

DO NOT SCALE FROM THIS PRINT

| TABLE 1     |               |
|-------------|---------------|
| ENTRY STYLE | CONTACT       |
| -PE         | SUB-HLE-PE-XX |
| -TE         | C-132-09-XX   |

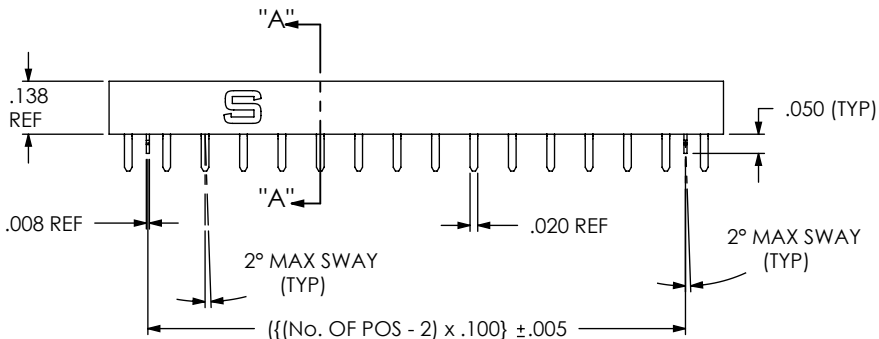
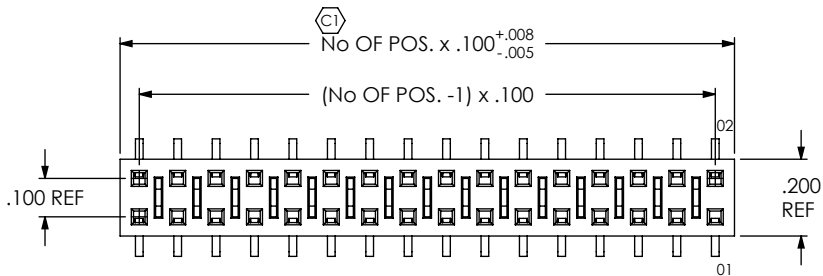
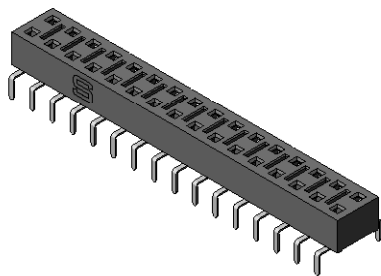

HLE-1XX-02-XX-DV-XE-XX

- No OF POSITIONS**  
-02 THRU -50 (PER ROW)
- LEAD STYLE**  
-02
- PLATING SPECIFICATION**  
-G: GOLD (SEE TABLE 1)  
-L: LIGHT SELECTIVE GOLD, MATTE TIN TAIL (SEE TABLE 1)  
-S: SELECTIVE GOLD, MATTE TIN TAIL (SEE TABLE 1)  
-LM: LIGHT SELECTIVE GOLD, MATTE TIN TAIL (SEE TABLE 1)  
-SM: SELECTIVE GOLD, MATTE TIN TAIL (SEE TABLE 1)  
-F: FLASH SELECTIVE GOLD, MATTE TIN TAIL (SEE TABLE 1)
- OPTION**  
-BE: BOTTOM ENTRY (USE RHLE-50-DBE) (SEE FIG. 3) (AVAILABLE ON -PE STYLE ONLY)   
-LC: LOCKING CLIP (SEE NOTE 10) (USE LC-08-TM-01) (AVAILABLE ON -PE STYLE ONLY)  
-TR: TAPE & REEL (2 - 29 POSITIONS ONLY) (-TE & -PE OPTIONS ONLY)  
-P: METAL PAD (USE MPP-02) (SEE FIG. 2)
- ENTRY STYLE**  
-PE: PASS THROUGH ENTRY (SEE FIG. 1)  
-TE: TOP ENTRY (SEE FIG. 2)
- ROW SPECIFICATION**  
-DV: DOUBLE VERTICAL (USE RHLE-50-DXX)

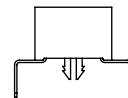

(SEE SECTION "A"- "A", SHT 2 FOR DIMENSIONS)

FIGURE 1  
(-PE: PASS THROUGH ENTRY)  
(SHOWN WITH -LC OPTION)

NOTES:

1. (C) REPRESENTS A CRITICAL DIMENSION.
2. CUT ASSEMBLIES AFTER FILL. CUT FLASH TO BE .010 MAX WITH NO FLASH ALLOWED IN HOLES OR EXTENDING BELOW LEADS. WILL LOSE A POSITION FOR EVERY CUT.
3. TUBE POSITIONS 03 THRU 50. LAYER PACKAGE POSITION 02.
4. ENDWALL THICKNESS: .030 ± .003.
5. MINIMUM CONTACT RETENTION IN PLASTIC: 12 OUNCES
6. AFTER PLATING, PIN IS NAMED SUB-C-132-10-X. AFTER FORMING, PIN IS C-132-10-X
7. MAX VARIATION OF 3 DEGREES WITHIN 16 PINS.
8. MEASURE FROM BEND TO TIP OF PIN.
9. MEASURE FROM CONTACT BARB AREA TO TIP OF PIN
10. DUE TO THE HIGH AMOUNT OF INSERTION FORCE NEEDED, THE -LC OPTION IS NOT COMPATIBLE WITH AUTO PLACEMENT, SAMTEC RECOMMENDS MANUAL PLACEMENT FOR ALL ASSEMBLIES WITH THE -LC OPTION.

|  |   |  |  |
|--|---|--|--|
| UNLESS OTHERWISE SPECIFIED, DIMENSIONS ARE IN INCHES. TOLERANCES ARE:<br>DECIMALS      ANGLES<br>.XX: ±.01            2°<br>.XXX: ±.005<br>.XXXX: ±.0020 | <b>PROPRIETARY NOTE</b><br>THIS DOCUMENT CONTAINS INFORMATION CONFIDENTIAL AND PROPRIETARY TO SAMTEC, INC. AND SHALL NOT BE REPRODUCED OR TRANSFERRED TO OTHER DOCUMENTS OR DISCLOSED TO OTHERS OR USED FOR ANY PURPOSE OTHER THAN THAT WHICH IT WAS OBTAINED WITHOUT THE EXPRESSED WRITTEN CONSENT OF SAMTEC, INC. |   |  |
|  |   | 520 PARK EAST BLVD, NEW ALBANY, IN 47150<br>PHONE: 812-944-6733      FAX: 812-948-5047<br>e-Mail: info@SAMTEC.com      code: 55322 |  |
| <b>MATERIAL:</b> DO NOT SCALE DRAWING      SHEET SCALE: 2:1  | DESCRIPTION:<br>.100 C.L. SINGLE BEAM SOCKET STRIP  |  |  |
| BODY: VECTRA E130i<br>COLOR: BLACK   | DWG. NO.<br><b>HLE-1XX-02-XX-DV-XE-XX</b>   |  |  |
| CONTACT: BeCu  | BY: KEVIN B      10/27/99   | SHEET 1 OF 2   |  |
| F:\DWG\MISC\MKTG\HLE-1XX-02-XX-DV-XE-XX-MKT.SLDDRW   |   |  |  |

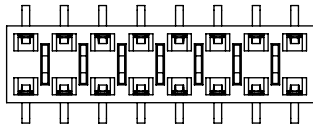

FIGURE 3  
(BOTTOM ENTRY OPTION)

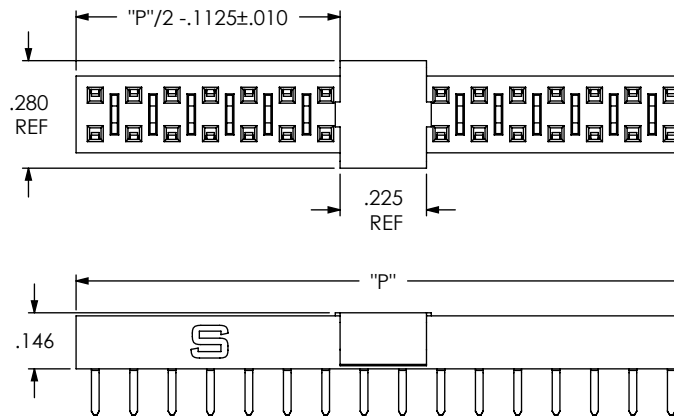
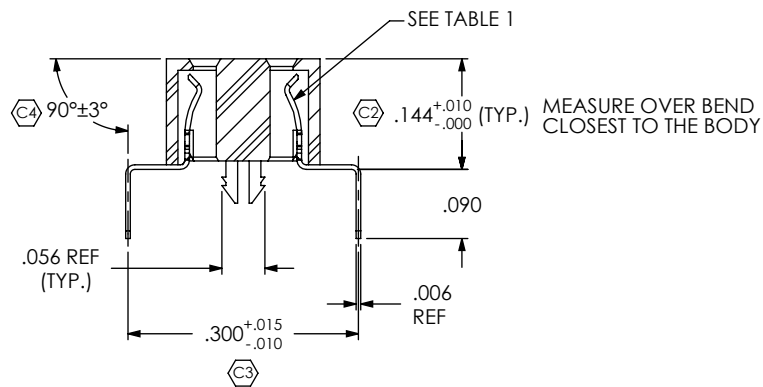
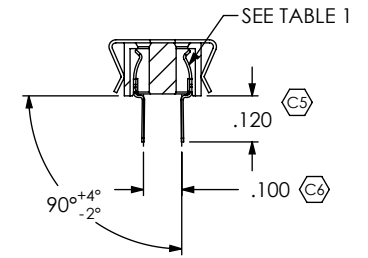

FIGURE 2  
(-TE WITH -P OPTION)



SECTION "A"- "A"  
SCALE 4 : 1

NOTES:

1. NOTE DELETED.
2. NOTE DELETED.
3. NOTE DELETED.
4. NOTE DELETED.

| ENTRY STYLE | PACKAGING TUBE    | PLUG  |
|-------------|-------------------|-------|
| -PE         | PT-1-24-05-38     | TP-03 |
| -TE         | PT-1-24-11-09     | TP-09 |
| -TE-P       | PT-HLE001-DV-TE-P | TP-03 |

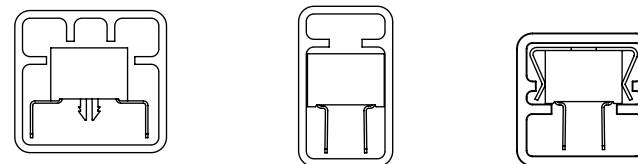

PACKAGING VIEWS

F:\DWG\MISC\MKTG\HLE-1XX-02-XX-DV-XE-XX-MKT.SLDRW

PROPRIETARY NOTE

THIS DOCUMENT CONTAINS INFORMATION CONFIDENTIAL AND PROPRIETARY TO SAMTEC, INC. AND SHALL NOT BE REPRODUCED OR TRANSFERRED TO OTHER DOCUMENTS OR DISCLOSED TO OTHERS OR USED FOR ANY PURPOSE OTHER THAN THAT WHICH IT WAS OBTAINED WITHOUT THE EXPRESSED WRITTEN CONSENT OF SAMTEC, INC.



520 PARK EAST BLVD, NEW ALBANY, IN 47150  
PHONE: 812-944-6733 FAX: 812-948-5047  
e-Mail: info@SAMTEC.com code: 55322

SHEET SCALE: 2:1

DESCRIPTION:  
.100 C.L. SINGLE BEAM SOCKET STRIP

DWG. NO.  
HLE-1XX-02-XX-DV-XE-XX

BY: KEVIN B 10/27/99 SHEET 2 OF 2