

Agilent U2722A/U2723A USB Modular Source Measure Unit

Voltage and current programming
and readback

Data Sheet



The Agilent U2722A/U2723A USB modular source measure unit is more than just a power supply – it has fast response time, and voltage and current programming/readback with high accuracy measurement capabilities. The U2722A and its enhanced version, the U2723A, are capable of four-quadrant operation, acting as a current source as well as the current sink (load) with both polarities of the output voltage. The U2723A offers additional features such as embedded test scripts to simplify automated testing, and faster rise time to help improve throughput during mass testing of semiconductor components.



Agilent Technologies

Introduction

Features

- Three-channel SMU
- Four-quadrant operation (± 20 V, ± 120 mA)
- Maximum current output of 120 mA per channel
- Embedded test script that is able to support three channels with coherent source and measurement capabilities (for U2723A)
- IV Curve application support in the Agilent Measurement Manager software (for U2723A)
- High measurement sensitivity of 100 pA with 16-bit resolution
- 0.1% basic accuracy
- Low current measurement capability down to nA levels
- High-speed USB 2.0 and USBTMC-USB488 standards
- Standalone and modular
- SCPI and IVI-COM supported

Increase the efficiency of your tests

With a high measurement sensitivity of 100 pA at 16-bit resolution for pico-level measurement and 0.1% accuracy, the U2722A/U2723A USB modular source measure unit provides more detailed and accurate analysis and measurement results.

U2722A/U2723A supports SCPI and IVI-COM. The SMU is compatible with a wide range of Application Development Environments, minimizing your work time and increasing your software options. Save time and effort with the bundled Agilent Measurement Manager (AMM) software, which converts SCPI commands into snippets of VEE, VB, C++ and C# code with the command logger function.

Pre-define test configurations and execute commands automatically

The U2723A USB modular source measure unit provides an embedded test script to help you pre-define test configurations or duplicate tests easily without spending too much time on programming.

Each channel in the U2723A USB modular SMU is allocated two memory lists, each capable of storing up to 200 commands and results individually. Stored commands in active memory will be executed accordingly while the measurement results obtained are automatically stored in the result buffer.

Four-quadrant operations with high measurement sensitivity and accuracy

The U2722A/U2723A SMU is a versatile device that allows you to perform sweep and measurement from different operating regions without needing extra configurations. The four-quadrant operation (± 20 V, ± 120 mA) makes the U2722A/U2723A SMU well suited for a wide range of test applications, including leakage measurement, solar cell measurement, forward/reverse voltage and curve tracer transistors. The U2722A/U2723A SMU also offers high measurement sensitivity with 16-bit resolution and accuracy that allows you to obtain more accurate analysis and measurement results.

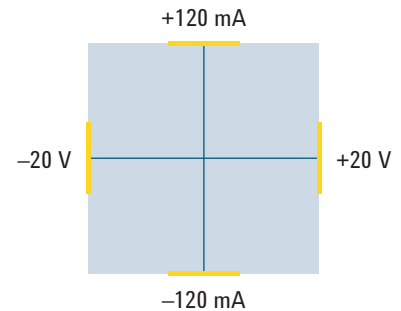

U2722A/U2723A USB Modular Source Measure Unit

Product outlook and dimensions

Front view

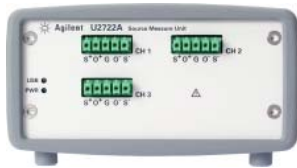

Rear view



Top view

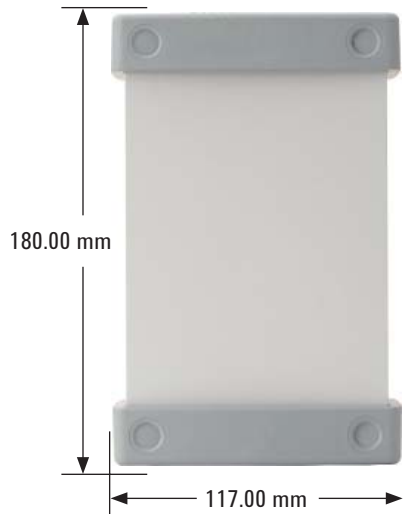

Product characteristics and general specifications

Remote interface	<ul style="list-style-type: none"> • Hi-Speed USB 2.0* • USBTMC-USB488¹
Power consumption	<ul style="list-style-type: none"> • +12 VDC, 3 A maximum • Isolated ELV supply source
Operating environment	<ul style="list-style-type: none"> • Operating temperature from 0 °C to +50 °C • Relative humidity at 20% to 85% RH (non-condensing) • Altitude up to 2000 meters • Pollution Degree 2 • For indoor use only
Storage compliance	-20 °C to 70 °C
Safety compliance	Certified with: <ul style="list-style-type: none"> • IEC 61010-1:2001/EN 61010-1:2001 (2nd Edition) • USA: ANSI/UL 61010-1:2004 • Canada: CSA C22.2 No.61010-1:2004
EMC compliance	<ul style="list-style-type: none"> • IEC 61326-1:2005/EN61326-1:2006 • Canada: ICES-001:2004 • Australia/New Zealand: AS/NZS CISPR 11:2004
Shock and vibration	Tested to IEC/EN 60068-2
IO connector	Output connectors
Dimension (W × D × H)	Module dimension: <ul style="list-style-type: none"> • 120.00 mm x 183.00 mm x 66.00 mm (with bumpers) • 105.00 mm x 175.00 mm x 50.00 mm (without bumpers)
Weight	Module dimension: <ul style="list-style-type: none"> • 700 g (with bumpers) • 650 g (without bumpers)
Warranty	One year for U2722A/U2723A Three months for standard shipped accessories

1. Compatible with Microsoft® Windows® operating systems only.

* If remote connections are necessary, a E5813A USB/LAN hub can be used. Please go to the product's user guide for more information.

Standard shipped accessories

- 12 V, 3 A AC/DC Power adapter
- Power cord
- Plug-in connectors and cable casing
- USB Standard-A to Mini-B interface cable
- L-Mount kit (used with modular product chassis)
- Quick Start Guide
- Agilent Measurement Manager Quick Reference Card
- Reference CD-ROM
- Agilent Automation-Ready CD-ROM (contains the Agilent IO Libraries Suite)
- Certificate of Calibration

Product Specifications

Model	U2722A/U2723A
Number of outputs	3

Output ratings (at 0 °C to 50 °C)	
Voltage	-20 V to 20 V
Current	-120 mA to 120 mA

Performance specification			
U2722A/U2723A	Range	Accuracy ¹	Resolution
Voltage programming 12 months (at 25 °C ± 3 °C), ±(% of output + offset)	±2 V	0.075% + 1.5 mV	0.1 mV
	±20 V	0.05% + 10 mV	1 mV
	±1 µA	0.085% + 0.85 nA	100 pA
	±10 µA	0.085% + 8.5 nA	1 nA
Current programming 12 months (at 25 °C ± 3 °C), ±(% of output + offset)	±100 µA	0.075% + 75 nA	10 nA
	±1 mA	0.075% + 750 nA	100 nA
	±10 mA	0.075% + 7.5 µA	1 µA
	±120 mA	0.1% + 100 µA	20 µA
Voltage readback 12 months (over USB with respect to the actual output at 25 °C ± 3 °C), ±(% of output + offset)	±2 V	0.075% + 1.5 mV	0.1 mV
	±20 V	0.05% + 10 mV	1 mV
	±1 µA	0.085% + 0.85 nA	100 pA
	±10 µA	0.085% + 8.5 nA	1 nA
Current readback 12 months (over USB with respect to the actual output at 25 °C ± 3 °C), ±(% of output + offset)	±100 µA	0.075% + 75 nA	10 nA
	±1 mA	0.075% + 750 nA	100 nA
	±10 mA	0.075% + 7.5 µA	1 µA
	±120 mA	0.1% + 100 µA	20 µA

1. Accuracy measurements are based on NPLC 10.

Product Specifications (continued)

Performance characteristics			
Rise/fall time (ms) ¹		U2722A	U2723A
	±1 µA	170.0	15.0
	±10 µA	18.0	5.0
For resistive measurement ²	±100 µA	6.0	1.0
	±1 mA	1.0	1.0
	±10 mA	1.0	1.0
	±120 mA	1.0	1.0
Remote sense operating range	Ensure that the maximum voltage between the OUTPUT+ and SENSE+, OUTPUT–, and SENSE– does not exceed 3 V		
Temperature coefficient	Maximum change in output/readback per °C after a 30-minute warm-up is 0.15		
Guard output resistance	0.2 kΩ		
Noise 10 Hz to 20 MHz (peak-peak)	100 mV typical into a resistive load (floating mode)		
Output voltage overshoot, ±(% of output + offset) ²	During turn-on or turn-off, the output plus overshoot < 0.1% + 10 mV		
Programming language	SCPI (Standard Commands for Programmable Instruments)		
Maximum sense lead resistance	1 MΩ for rated accuracy		
Voltage line regulation	0.01% of range		
Voltage load regulation	0.01% + 100 µV		
Current line regulation	0.04% of range		
Current load regulation	0.04% + 100 µA		
Recommended calibration interval	One year		

1. Drive 50% of 1 V or 10 V output with a resistive load. Rise time is from 10% to 90% of program voltage change at maximum current. Fall time is from 90% to 10% of program voltage change at maximum current.

2. Measurements obtained are per default bandwidth setting.

NOTE

- All channels are isolated from the ground and from each other. Isolation is +60 VDC, Category 1.
- All specifications are based on a three-hour warm-up time.
- The measurement accuracy value is $x (1 + a * y)$, where,
 - x = accuracy specification at room temperature,
 - a = temperature coefficient, and
 - y = temperature change from room temperature in °C

Noise 10 Hz to 20 MHz (Peak-peak)						
Voltage range	Current range					
	1 µA	10 µA	100 µA	1 mA	10 mA	120 mA
2 V	50 mV	50 mV	50 mV	50 mV	30 mV	30 mV
20 V	50 mV	50 mV	50 mV	50 mV	30 mV	30 mV

Agilent Measurement Manager

The Agilent Measurement Manager (AMM) is an application data viewer software that comes with the standard purchase of the U2700A Series USB modular instruments. This software is designed to help you perform quick device configuration, data logging and data acquisition using the products.

Supported features found in the U2722A/U2723A USB modular source unit:

- Command logger to allow the capture of configuration commands that can be easily converted to snippets of VEE, VB, C++ and C# code
- Self-test
- Self-calibration
- Option to save the current instrument configuration to a file
- Data logging and export feature to CSV, HTML and text only format files that can be printed
- Trigger settings between modules in the instrument chassis with Star trigger and Master/Slave trigger

Agilent Measurement Manager prerequisites

Prior to installing the Agilent Measurement Manager software, ensure that your PC meets the following minimum system requirements for installation and operation.

Hardware requirements	
Processor	1.6 GHz Pentium IV or higher
Operating system	One of the following Microsoft Windows versions: <ul style="list-style-type: none"> • Windows XP Professional or Home edition (Service Pack 1 or later) • Windows Vista 32-bit (Business, Ultimate, Enterprise, Home Basic and Home Premium edition) • Windows 7 32-bit (Home Basic, Home Premium, Professional, Enterprise and Ultimate edition)
Hard disk space	1 GB
RAM	512 MB or higher recommended
Video	Super VGA (800 x 600), 256 colors or more

Software requirements	
Agilent IO Libraries Suite 15.1 and above ¹	
Agilent T&M Toolkit Runtime version 2.1 ²	
Agilent T&M Toolkit Redistributable Package 2.1 patch ²	
Microsoft .NET Framework version 2.0 ²	

1. Available on the Agilent Automation-Ready CD-ROM
2. Bundled with Agilent Measurement Manager software application installer

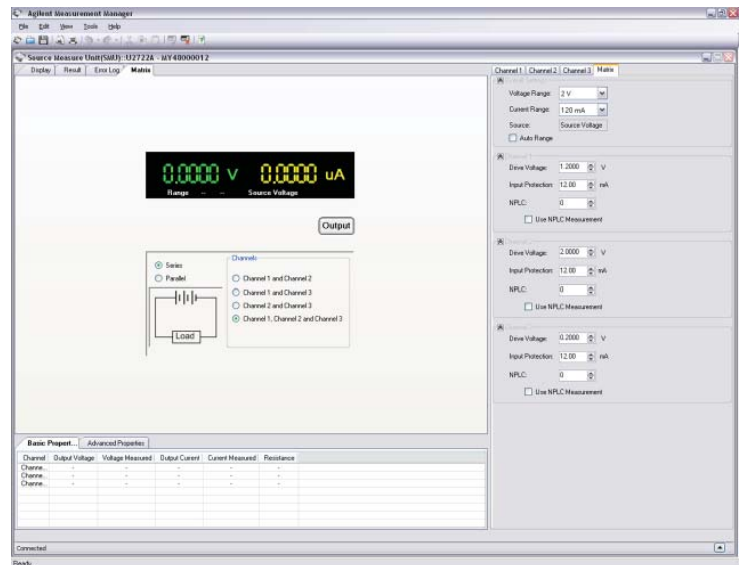
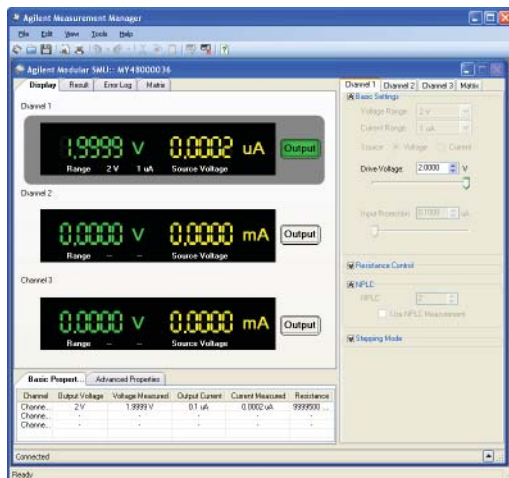

U2942A Parametric Measurement Manager Pro Software

Measure and analyze with ease

Agilent Parametric Measurement Manager Pro (PMM Pro) is a VEE-based software designed to perform basic semiconductor testing. The software specializes in the analysis of discrete semiconductor devices such as diodes, bipolar junction transistors and field effect transistors.

Designed for use with the Agilent U2722A/U2723A USB source measure unit and the U2941A parametric test fixture, Agilent PMM Pro controls the instruments to take parametric measurements such as voltage or current. The software then plots, displays and logs the results in an IV curve.

Agilent PMM Pro allows users to carry out measurements and display results without the need for prior programming experience. The software operates through an intuitive user-interface that is easy to understand and configure, and includes test sequence automation to further ease your task.

Features

- Uses an intuitive GUI that is easy to configure and simplifies testing
- Comes with predefined test profiles for diode, bipolar junction transistors and field effect transistors, removing the need for programming experience
- Allows users to define and configure test profiles
- Automates test sequencing for parametric analysis
- Plots, displays and logs parametric measurements in an IV curve
- Includes built-in math functions such as addition, subtraction and division for quick analysis of results

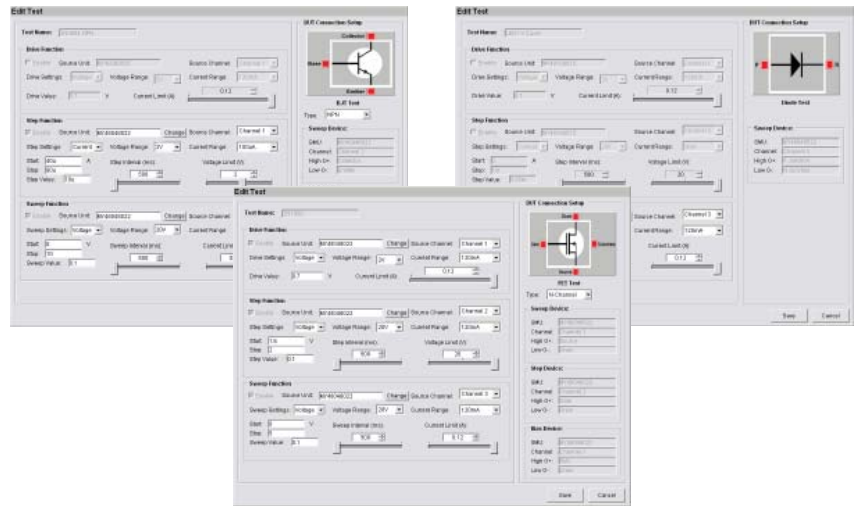

Figure 1. Intuitive GUI that features both pre-defined and user-defined test profile.

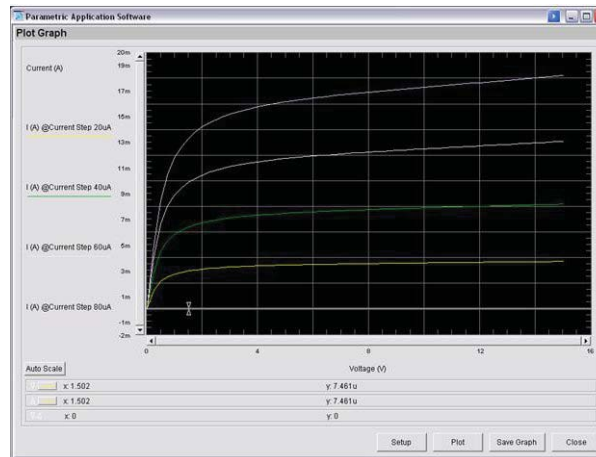
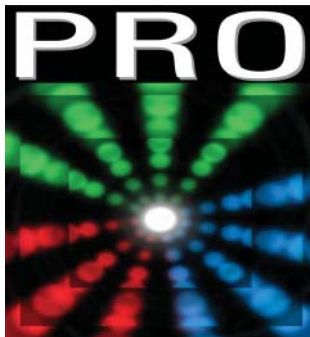

Figure 2. Plots, displays and logs parametric measurements in an IV curve.

U2942A Parametric Measurement Manager Pro Software (continued)

Minimum system requirements for PMM Pro

System requirements		
Operating system	Microsoft Windows XP SP3 or higher	<ul style="list-style-type: none">• Microsoft Windows 7 (Professional, Ultimate, Enterprise)• Microsoft Windows Vista® SP1 (Business, Ultimate, Enterprise) or higher
Architecture	x86 (32-bit), 64-bit for Windows 7 supportability ¹	
Prerequisite	<ul style="list-style-type: none">• Agilent IO Libraries Suite 15.0 or higher²• Agilent VEE Pro 9.0 or higher (Runtime version)³• Microsoft.NET Framework version 1.1 and 2.0³	
Processor	<ul style="list-style-type: none">• 450 MHz Pentium II or higher required• 800 MHz recommended	1 GHz required, 2 GHz recommended
Available memory	<ul style="list-style-type: none">• 128 MB minimum• 256 MB or higher recommended	1 GB minimum, 2 GB recommended
Available disk space	1 GB hard disk free space	
Video	Super VGA (800x600) display or higher resolution monitor with 256 colors or more	Support for DirectX 9 graphics with 128 MB graphics memory recommended (Super VGA graphics is supported)
Browser	Microsoft Internet Explorer 6.0 or higher	Microsoft Internet Explorer 7 or higher

1. 32-bit application running on WOW64 (Windows-on-Windows) emulator.

2. Available on the Agilent Automation-Ready CD-ROM.

3. Bundled with the Agilent SMU PMM Pro software installer.

U2941A Parametric Test Fixture

Increase your parametric test efficiency and usability

The Agilent U2941A parametric test fixture is designed to complement usage of the Agilent U2722A/U2723A USB modular source measure unit in the testing of semiconductor components, including SMT and DIP ICs. The U2941A comes with three input channels, a common ground, and five types of socket modules of various pin configurations.

The bundled Agilent Parametric Measurement Manager (PMM) software also supports the Agilent U2751A USB modular switch matrix when used with the U2722A. The PMM software allows for out-of-box configuration of instruments for easy set-up, simplifying discrete package component testing and enabling data recording.

Features

- Closed lid minimizes ESD on sensitive circuits and components
- Up to 3 source/measure channels supported
- Different socket modules to match a wide variety of pin configurations
- Assembly Teflon plate for low-current measurements
- Comes with the Agilent Parametric Measurement Manager software



Figure 3. Sample setup of the U2941A connected directly to the U2722A source measure unit and fastened with the DIP socket module.

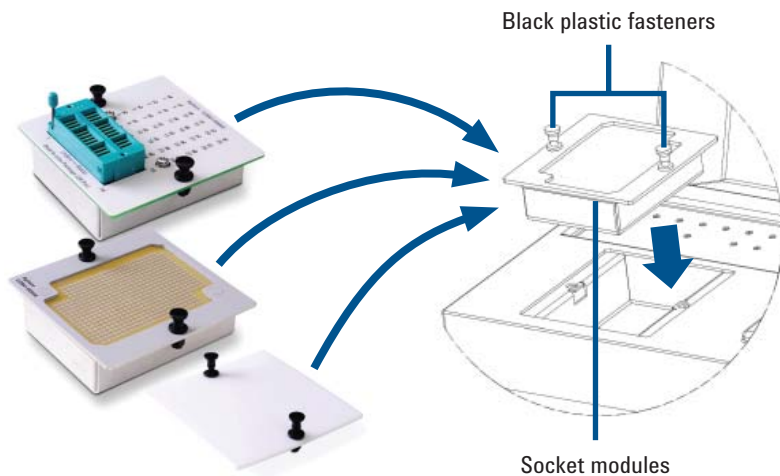
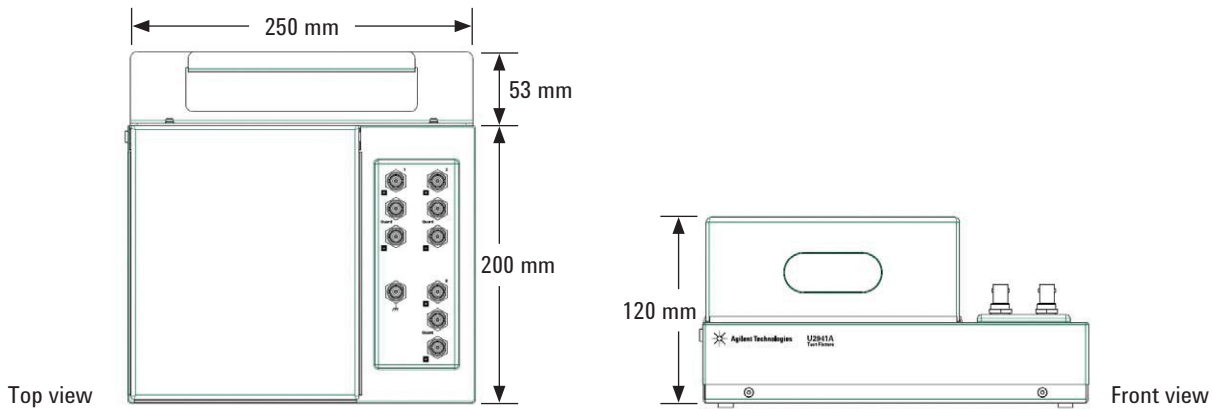

Figure 4. Socket modules are interchangeable to match pin configuration of device-under-test (DUT).

Specifications and System Requirements

The following specifications are valid for 23 °C ±5 °C and < 70% relative humidity.

Specifications	
Electrical specifications	Electrical specifications
Voltage rating	60 VDC
Current rating	1 A
Environmental specifications	
Operating temperature	0 °C to 50 °C
Storage temperature	-20 °C to 70 °C
Operating humidity	20% to 85% RH non-condensing
Storage humidity	5% to 90% RH non-condensing
Altitude	Up to 2000 m
Physical specifications	
Dimensions (W×D×H)	250 mm × 200 mm × 120 mm
Weight	1.33 kg (approximate)
Warranty	3 months



Minimum system requirements

Hardware	
Processor	1.6 GHz Pentium IV or higher
RAM	512 MB (1.0 GB or higher recommended)
Hard disk space	1 GB free disk space at runtime
Display resolution	1024 × 768 recommended
Operating system and browser	
Operating system	<ul style="list-style-type: none"> Windows XP Professional or Home Edition, Service Pack 1 or later; or Windows 2000 Professional, Service Pack 4 or later
Browser	Microsoft Internet Explorer 5.01 (6.0 or higher recommended)
Software	
Agilent IO Libraries Suite ¹	Version 15.0 or higher
Agilent VEE ²	Runtime version 8.5, patch 8.5.1
Agilent Measurement Manager ³	Version 1.6 or higher
Microsoft .NET Framework ¹	Version 1.1 and 2.0

1. Available on Agilent Automation-Ready CD

2. Bundled with Agilent Parametric Measurement Manager CD

3. Bundled with Agilent U2722A USB modular source measure unit or Agilent U2751A USB modular switch matrix

U2722P/U2723P Parametric Measurement Solution

Measure and analyze quickly and efficiently with all your essential parametric measurement tools at your fingertips

Parametric testing is used across a variety of application and industries – from a teaching tool in the education sector to manufacturing and troubleshooting in the semiconductor industry. Now, you can measure and analyze quickly and efficiently in all these areas with the one-stop Parametric Measurement Solution.

The Parametric Measurement Solution bundle consists of the Agilent U2722A/U2723A USB modular source measurement unit and the Agilent Parametric Measurement Manager Pro software, providing you a basic yet complete parametric measurement test solution that analyzes the performance of components such as diodes and transistors without the need for prior programming experience. The optional Agilent U2941A parametric test fixture can further increase your parametric test efficiency and usability.

The U2722P/U2723P Parametric Measurement Solution bundle is only available in Europe and Asia, excluding Japan.

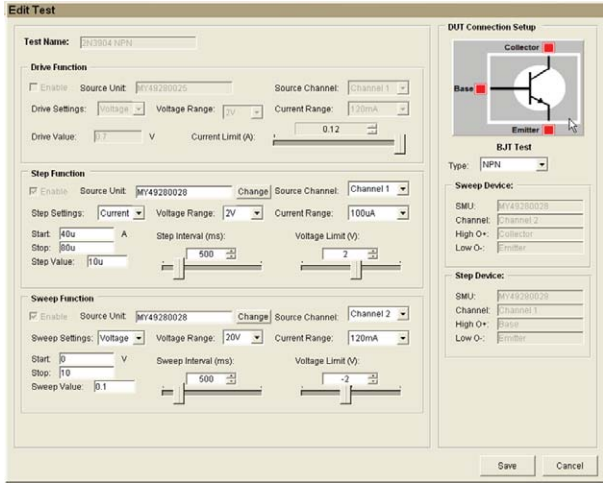
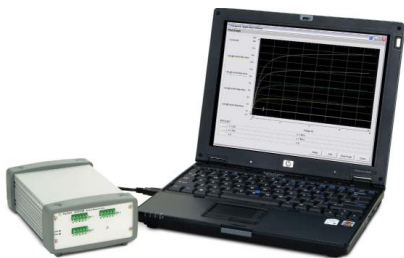

Figure 5. Easily configure an I-V characterization test with the Parametric Measurement Manager Pro software.

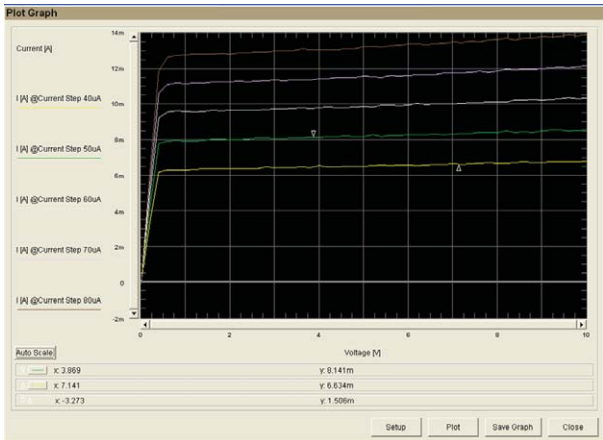

Figure 6. Execute the I-V characterization test to view results instantly.

Index	V (V)	I [A] @Current Step 40uA	I [A] @Current Step 50uA	I [A] @Current Step 60uA	I [A] @Current Step 70uA
1	0.00000E+00	-3.66211E-05	-5.12695E-05	-6.95000E-05	-8.59179E-05
2	2.00000E-01	3.36181E-03	4.18318E-03	4.92187E-03	5.49316E-03
3	4.00000E-01	6.21083E-03	7.78198E-03	9.25415E-03	1.06347E-02
4	6.00000E-01	8.29516E-03	7.92490E-03	9.58543E-03	1.11219E-02
5	8.00000E-01	9.30615E-03	7.90142E-03	9.62402E-03	1.11914E-02
6	1.00000E+00	9.31247E-03	7.86311E-03	9.59639E-03	1.11917E-02
7	1.20000E+00	9.33549E-03	7.85043E-03	9.58079E-03	1.12023E-02
8	1.40000E+00	9.26109E-03	7.87973E-03	9.60513E-03	1.12096E-02
9	1.60000E+00	9.35742E-03	8.02734E-03	9.66044E-03	1.12693E-02
10	1.80000E+00	9.36849E-03	8.02734E-03	9.62036E-03	1.12699E-02
11	2.00000E+00	9.38871E-03	8.01835E-03	9.68827E-03	1.12793E-02
12	2.20000E+00	9.36849E-03	8.00179E-03	9.66692E-03	1.12939E-02
13	2.40000E+00	9.38305E-03	8.04565E-03	9.65692E-03	1.12764E-02
14	2.60000E+00	9.38871E-03	8.09326E-03	9.66798E-03	1.13122E-02
15	2.80000E+00	9.47827E-03	8.10424E-03	9.68994E-03	1.13415E-02
16	3.00000E+00	9.42700E-03	8.07495E-03	9.74933E-03	1.13781E-02
17	3.20000E+00	9.42420E-03	8.09597E-03	9.74121E-03	1.13489E-02
18	3.40000E+00	9.45237E-03	8.13822E-03	9.77050E-03	1.13365E-02
19	3.60000E+00	9.48559E-03	8.11056E-03	9.78905E-03	1.13856E-02
20	3.80000E+00	9.45263E-03	8.14453E-03	9.78515E-03	1.13850E-02
21	4.00000E+00	9.53202E-03	8.13354E-03	9.81445E-03	1.14440E-02
22	4.20000E+00	9.47469E-03	8.17749E-03	9.84741E-03	1.14404E-02

Figure 7. The test results can also be viewed in tabular format for quick analysis.

Other products in the Agilent USB Modular Test Instruments Family



U2701A/U27012A USB Modular Oscilloscope

Features:

- High sampling rate up to 500 MSa/s, enabling accurate measurement analysis
- Up to 32 MB large memory
- Fast fourier transfer (FFT) and waveform math functions enables easy waveform calculation

For more information: <http://www.agilent.com/find/usbscope>



U2741A USB Modular Digital Multimeter (DMM)

Features:

- Fast reading speed (up to 100 Sa/s)
- Wide range of basic measurement functions, including frequency and temperature measurements

For more information: <http://www.agilent.com/find/U2741A>



U2751A USB Modular Switch Matrix

Features:

- Minimal cross-talk of -30 dB at 45 MHz wide bandwidth
- High bandwidth at 45 MHz without terminal block
- Capability to test up to four devices-under-test (DUTs)
- Works with other Agilent instruments for multi-point testing

For more information: <http://www.agilent.com/find/U2751A>



U2761A USB Modular Function/Arbitrary Waveform Generator

Features:

- Direct digital synthesis (DDS) waveform generator
- Pulse generator that can generate pulse signal as stimulus
- Easy customization with Arbitrary Waveform Editor
- Internal modulation capability simplifies test setup

For more information: <http://www.agilent.com/find/U2761A>



U2781A USB Modular Product Chassis

Features:

- Expansion of channels for each modular product
- Multiple instrument synchronization
- Internal and external 10 MHz reference clock
- High-speed USB 2.0
- SSI/Star trigger bus synchronization between external trigger source and modules

For more information: <http://www.agilent.com/find/U2781A>

Ordering Information

U2722A	USB modular source measure unit
U2723A	USB modular source measure unit with embedded test scripts
U2941A	Parametric test fixture, shipped with: <ul style="list-style-type: none"> • Assembly Teflon plate • 28-pin dual-in-line package (DIP) socket module • 0.1-inch universal socket module • 0.075-inch universal socket module • 0.05-inch universal socket module • Pin plug-topin plug cables, black (4 pcs) • Pin plug-topin plug cables, red (4 pcs) • Pin plug-topin plug cables, blue (4 pcs) • Pin plug-to-miniature clip cables, black (4 pcs) • Pin plug-to-miniature clip cables, red (4 pcs) • Pin plug-to-miniature clip cables, blue (4 pcs) • PCB jumper pin • BNC to two-wire cable, 1 m (3 pcs) • Agilent Parametric Measurement Manager CD (includes installation and operation guide)
U2942A	Parametric Measurement Manager Pro software
U2722P*	U2722A USB modular source measure unit and U2942A Parametric Measurement Manager Pro bundle
U2723P*	U2723A USB modular source measure unit and U2942A Parametric Measurement Manager Pro bundle

* Only available in Europe and Asia (excluding Japan)

Optional accessories for the U2700 Series

U2921A-101	USB secure cable, 2 m
------------	-----------------------

Optional accessories for the U2941A parametric test fixture

U2941A-101	Pin plug-to-pin plug cable, black
U2941A-102	Pin plug-to-pin plug cable, red
U2941A-103	Pin plug-to-pin plug cable, blue
U2941A-104	Pin plug-to-miniature clip cables, black
U2941A-105	Pin plug-to-miniature clip cables, red
U2941A-106	Pin plug-to-miniature clip cables, blue
U2941A-107	BNC to two-wire, 1 m
U2941A-201	Assembly Teflon plate <ul style="list-style-type: none"> • Insulation board with minimal leakage current; suitable for extremely low-current measurement
U2941A-202	28-pin dual-in-line package (DIP) socket module <ul style="list-style-type: none"> • Lever actuated zero insertion force (ZIF) socket
U2941A-203	0.1-inch universal socket module <ul style="list-style-type: none"> • 0.1-inch pitch; suitable for virtually any device such as components, DIP IC or small scale circuit
U2941A-204	0.075-inch universal socket module <ul style="list-style-type: none"> • 0.075-inch pitch; suitable for virtually any device such as components, DIP IC or small scale circuit
U2941A-205	0.05-inch universal socket module <ul style="list-style-type: none"> • 0.05-inch pitch; suitable for any device such as components, DIP IC or small scale circuit



Agilent Email Updates

www.agilent.com/find/emailupdates

Get the latest information on the products and applications you select.



www.axistandard.org

AdvancedTCA® Extensions for Instrumentation and Test (AXIe) is an open standard that extends the AdvancedTCA® for general purpose and semiconductor test. Agilent is a founding member of the AXIe consortium.



www.lxistandard.org

LAN eXtensions for Instruments puts the power of Ethernet and the Web inside your test systems. Agilent is a founding member of the LXI consortium.



<http://www.pxisa.org>

PCI eXtensions for Instrumentation (PXI) modular instrumentation delivers a rugged, PC-based high-performance measurement and automation system.

Agilent Channel Partners

www.agilent.com/find/channelpartners

Get the best of both worlds: Agilent's measurement expertise and product breadth, combined with channel partner convenience.

Microsoft and Windows are trademarks or registered trademarks of Microsoft Corporation in the United States and/or other countries.

Windows Vista is a trademark or registered trademark of Microsoft Corporation in the United States and/or other countries.



Agilent Advantage Services is committed to your success throughout your equipment's lifetime. We share measurement and service expertise to help you create the products that change our world. To keep you competitive, we continually invest in tools and processes that speed up calibration and repair, reduce your cost of ownership, and move us ahead of your development curve.

www.agilent.com/find/advantageservices



www.agilent.com/quality

www.agilent.com
www.agilent.com/find/U2722A
www.agilent.com/find/U2723A

For more information on Agilent Technologies' products, applications or services, please contact your local Agilent office. The complete list is available at:

www.agilent.com/find/contactus

Americas

Canada	(877) 894 4414
Brazil	(11) 4197 3500
Mexico	01800 5064 800
United States	(800) 829 4444

Asia Pacific

Australia	1 800 629 485
China	800 810 0189
Hong Kong	800 938 693
India	1 800 112 929
Japan	0120 (421) 345
Korea	080 769 0800
Malaysia	1 800 888 848
Singapore	1 800 375 8100
Taiwan	0800 047 866
Other AP Countries	(65) 375 8100

Europe & Middle East

Belgium	32 (0) 2 404 93 40
Denmark	45 70 13 15 15
Finland	358 (0) 10 855 2100
France	0825 010 700*
	*0.125 €/minute
Germany	49 (0) 7031 464 6333
Ireland	1890 924 204
Israel	972-3-9288-504/544
Italy	39 02 92 60 8484
Netherlands	31 (0) 20 547 2111
Spain	34 (91) 631 3300
Sweden	0200-88 22 55
United Kingdom	44 (0) 118 9276201

For other unlisted Countries:

www.agilent.com/find/contactus

Revised: October 14, 2010

Product specifications and descriptions in this document subject to change without notice.

© Agilent Technologies, Inc. 2011
Printed in USA, March 23, 2011
5990-7416EN



Agilent Technologies