



### FEATURES

- ◆Wide (2:1) Input Range
- ◆Short Circuit Protection(automatic recovery)
- ◆1500VDC Isolation
- ◆Operating Temperature: -40℃~ + 85℃
- ◆Six sided metal shielding
- ◆Over Voltage protection
- ◆Internal SMD construction
- ◆RoHS/CE Compliance
- ◆Industry Standard Pin Out
- ◆MTBF>1000Khours

### MODEL SELECTION

**WRB<sup>①</sup> 24<sup>②</sup> 15<sup>③</sup> Y<sup>④</sup> D<sup>⑤</sup> -20W<sup>⑥</sup> (2.16)<sup>⑦</sup>**

- ①Product Series    ②Input Voltage  
 ③Output Voltage    ④Wide (2:1) Input Range  
 ⑤DIP Package Style    ⑥Rated Power  
 ⑦Product size(L×W):50.8×40.6mm(2×1.6inch)

### APPLICATIONS

The WR-YD-20W(2.16) Series are specially designed for applications where a wide range input voltage power supplies are isolated from the input power supply in a distributed power supply system on a circuit board.

These products apply to:

- 1)Where the voltage of the input power supply is wide range (Voltage ranges≤2:1);
- 2)Where isolation is necessary between input and output (Isolation voltage≤1500VDC);
- 3)Where the regulation of the Output voltage and the output ripple noise are demanded.



### SELECTION GUIDE

Order code	Input		Output		Efficiency (%.Typ.)	Capacitance (max,UF.)
	Voltage(VDC)		Voltage (VDC)	Current (mA,Typ.)		
	Nominal	Range				
WRA1203YD-20W	12	9-18	±3.3	±2000	85	19000
WRA1205YD-20W	12	9-18	±5	±2000	88	10300
WRA1212YD-20W	12	9-18	±12	±833	83	3340
WRA1215YD-20W	12	9-18	±15	±667	82	1100
WRA1224YD-20W	12	9-18	±24	±417	81	900
WRA2403YD-20W	24	18-36	±3.3	±2000	81	19500
WRA2405YD-20W	24	18-36	±5	±2000	88	10200
WRA2412YD-20W	24	18-36	±12	±833	81	3300
WRA2415YD-20W	24	18-36	±15	±667	83	1100
WRA2424YD-20W	24	18-36	±24	±417	85	900
WRA4803YD-20W	48	36-75	±3.3	±2000	83	19500
WRA4805YD-20W	48	36-75	±5	±2000	81	10200
WRA4812YD-20W	48	36-75	±12	±833	81	3300
WRA4815YD-20W	48	36-75	±15	±667	84	1100
WRA4824YD-20W	48	36-75	±24	±417	81	900
WRB1203YD-20W	12	9-18	3.3	4000	85	19000
WRB1205YD-20W	12	9-18	5	4000	88	10300
WRB1212YD-20W	12	9-18	12	1667	83	3340
WRB1215YD-20W	12	9-18	15	1334	82	1100
WRB1224YD-20W	12	9-18	24	834	81	900
WRB2403YD-20W	24	18-36	3.3	4000	81	19500
WRB2405YD-20W	24	18-36	5	4000	88	10200
WRB2412YD-20W	24	18-36	12	1667	81	3300
WRB2415YD-20W	24	18-36	15	1334	83	1100
WRB2424YD-20W	24	18-36	24	834	85	900
WRB4803YD-20W	48	36-75	3.3	4000	83	19500
WRB4805YD-20W	48	36-75	5	4000	81	10200
WRB4812YD-20W	48	36-75	12	1667	81	3300
WRB4815YD-20W	48	36-75	15	1334	84	1100
WRB4824YD-20W	48	36-75	24	834	81	900

### COMMON SPECIFICATIONS

Parameter	Conditions	Min.	Typ.	Max.	Units
Storage humidity		5		95	%
Operating temperature		-40		85	℃
Storage temperature		-55		105	℃
Lead temperature	1.5mm from case for 10 seconds			300	℃
Case material	Steel,nickel coated, copper				
Isolation voltage	Tested for1 minute and 1mA max		1500		VDC
Isolation resistance			1000		MΩ
Isolation Capacitance	100KHz/1V		1000		pF
MTBF			1000		K hours
Weight			45		g

### INPUT SPECIFICATIONS

Parameter	Conditions	Min.	Typ.	Max.	Units
Start up time			20		MS
Input filter				Pi	
Method of Remote (Reference point:GND)	On	2.5-30VDC or open circuit			
	Off	0-1.2VDC			

TEMPERATURE CHARACTERISTICS					
Parameter	Conditions	Min.	Typ.	Max.	Units
Output voltage accuracy	Refer to recommended circuit		±1	±3	%
Over load protection	Input voltage range	120	130	150	%
Output Short Circuit	Input voltage range	Hiccup,automatic recovery			
Load regulation	From 10% to 100% load		±0.5	±1	%
Trim		±10%Vo			VDC
Temperature drift (Vout)		0.02			%/°C
Line regulation	Input voltage from low to high		±0.2	±0.5	%
Ripple & Noise	Tested under 20MHz band	50	75	150	mV
Transient recovery time	25% load change		200	300	us
Transient peak deviation		±2	±3	±5	%
Over voltage protection	3.3V	3.63		4.29	VDC
	5V	5.5		6.5	VDC
	12V	13.2		15.6	VDC
	15V	16.5		19.5	VDC
	24V	26.4		31.2	VDC

Note:  
 1. All specifications are measured at TA=25°C, humidity<75%, nominal input voltage and rated output load unless otherwise specified.  
 2. The CTRL control pin voltage is referenced to GND.  
 3. Typical efficiency value at nominal input voltage and full load.  
 4. Capacitor MAX load tested at nominal input voltage and constant resistive load.  
 5. Refer to the diagram of Output Voltage trim up/down for trim applications.  
 6. The products cannot be used in parallel and in plug and play.

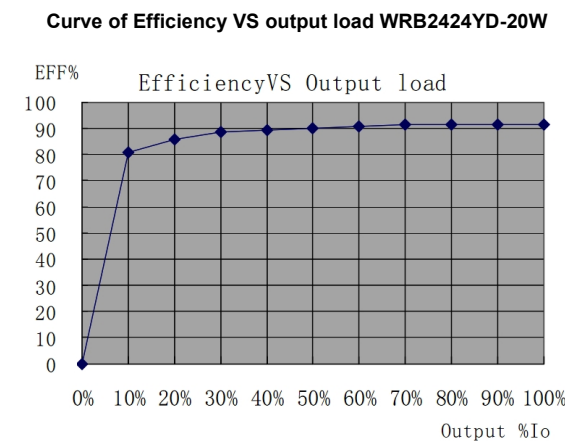
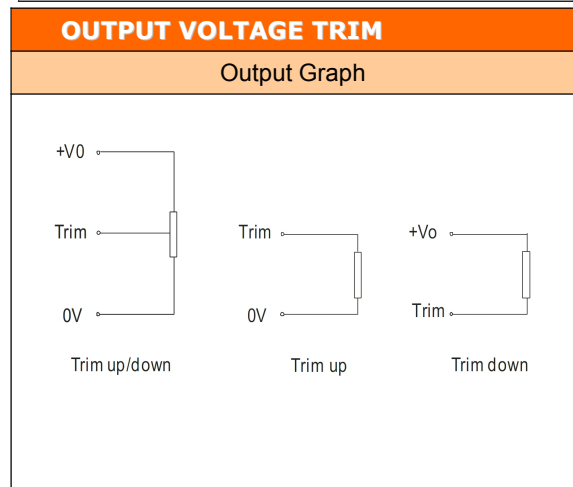
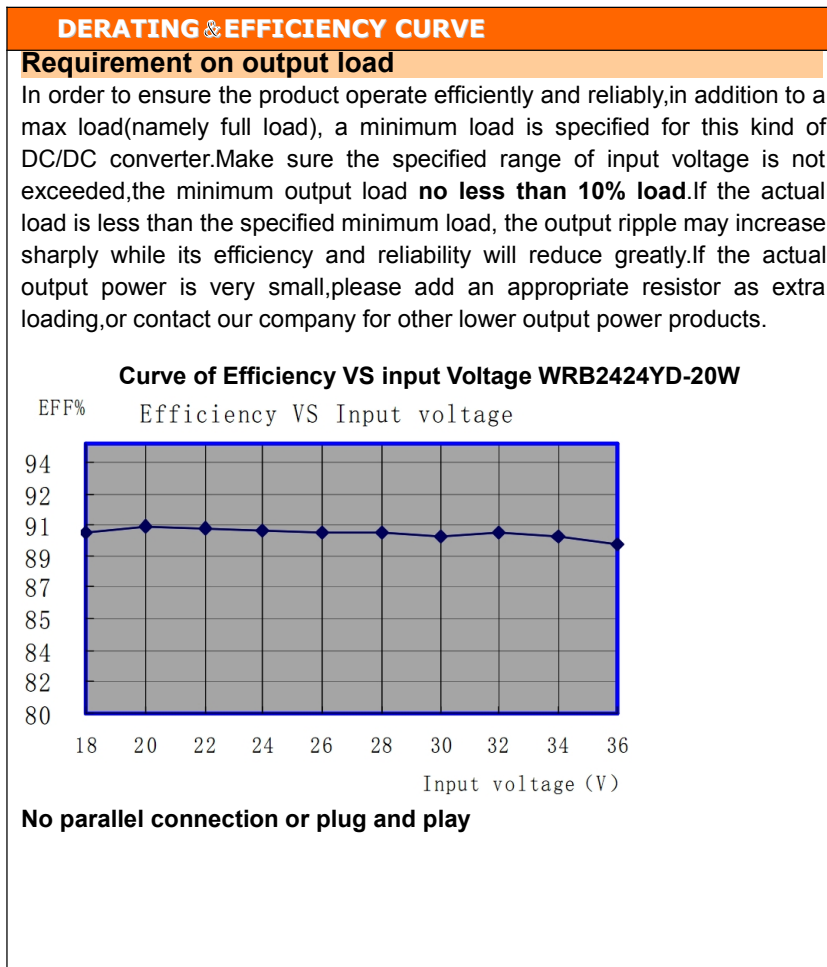
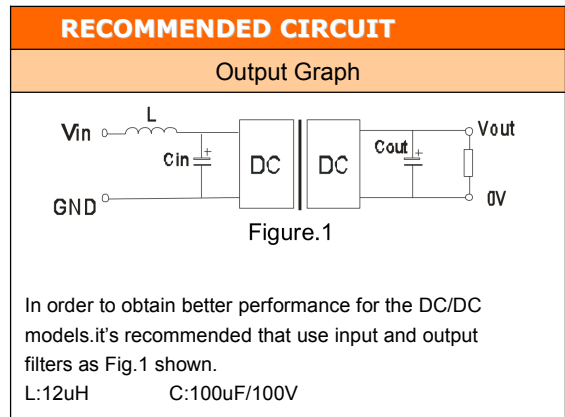
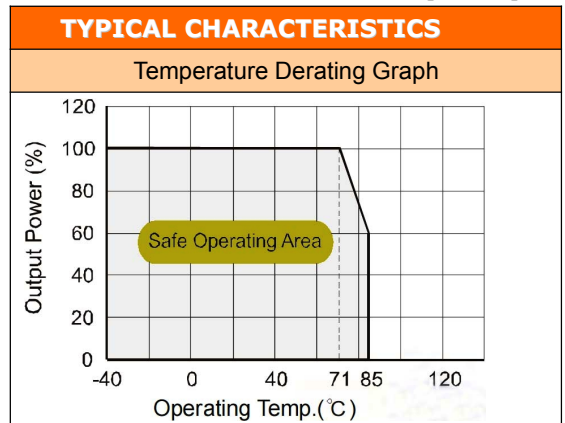

### OUTLINE DIMENSIONS & FOOTPRINT DETAILS

#### MECHANICAL DIMENSIONS

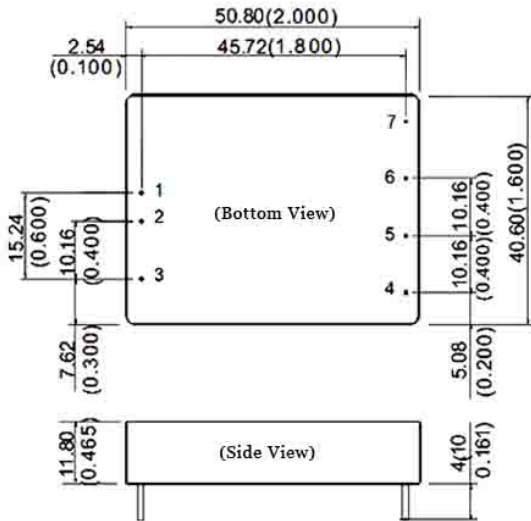

Note:  
 Unit:mm[inch]  
 Pin diameter:1.00mm(0.039inch)  
 Pin diameter tolerance:±0.05mm(±0.002inch)  
 General tolerances:±0.25mm(±0.010inch)

#### RECOMMENDED FOOTPRINT

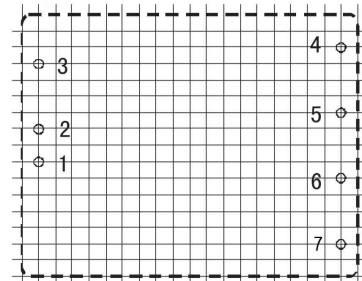

Top view grid:2.54mm(0.1inch)  
 Diameter:1.50mm(0.059inch)

#### FOOTPRINT DETAILS

Pin	Single	Dual
1	Vin	Vin
2	GND	GND
3	CTRL	CTRL
4	Trim	Trim
5	-Vo	-Vo
6	+Vo	Common
7	No Pin	+Vo

Note: The CTRL control pin voltage is referenced to GND

When the environment temperature is higher than 71°C, the product output power should be less than 60% of the rated power.  
 No parallel connection or plug and play.  
 Use dual output simultaneously, forbid pening output pin (0V) to use as single output.

#### TUBE OUTLINE DIMENSIONS

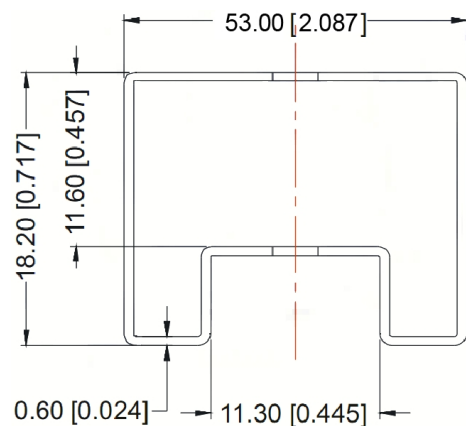

Note:  
 Unit :mm[inch]  
 General tolerances:±0.250mm[±0.010inch]

Note:

1. The CTRL control pin voltage is referenced to GND.
2. Typical efficiency value at nominal input voltage and full load.
3. All specifications measured at Ta=25°C, humidity<75%, nominal input voltage and rated output load unless otherwise specified.
4. In this data sheet, all the test methods of indications are based on corporate standards.
5. Capacitor MAX load tested at nominal input voltage and constant resistive load.