

ISOLATED DC/DC CONVERTERS

36 Vdc - 80 Vdc Input, 3.3 Vdc/3 A Output



Aug. 13, 2010

Bel Power Inc., a subsidiary of Bel Fuse Inc.

xRLP-10T03x RoHS Compliant PRELIMINARY Rev.C

Features

- Isolated
- High Efficiency
- Excellent Thermal Performance
- Low Cost
- Remote On/Off
- Class 1, Category 2, Isolated DC/DC Converter (refer to IPC-9592)
- UL60950-1 Recognized (UL/cUL) (Pending)
- Input Under Voltage Lockout
- Output Voltage Trim
- Output Over-Voltage Shutdown
- OCP/SCP
- Basic Insulation

Applications

- Networking
- Computers and peripherals
- Telecommunications

Description

The xRLP-10T03x is an isolated dc/dc converter that operates from a nominal 48 Vdc source. This unit provides up to 10 W of output power from a nominal 48 Vdc input. This unit is designed to be highly efficient and low cost. Features include remote on/off, over current protection, over voltage shut down, and under voltage lockout. This converter is provided in an industry standard 1X1 package.

Part Selection

Output Voltage	Input Voltage	Max. Output Current	Max. Output Power	Typical Efficiency	Model Number Active Low	Model Number Active High
3.3 Vdc	36 Vdc - 80 Vdc	3 A	10 W	82%	xRLP-10T03L	xRLP-10T033

Notes: Add "G" suffix at the end of the model number to indicate Tray Packaging.

Part Number Explanation

$\frac{x}{1} \frac{R}{2} \frac{LP}{3} - \frac{10}{4} \frac{T}{5} \frac{03}{6} \frac{x}{7}$

1---Replace "x" with "S" to indicate SMD package, or "0" to indicate through hole package

2---RoHS 6, change "R" to "7" means RoHS 5

3---Series name

4---Series code

5--- Input range (36-80V)

6---Output voltage (3.3V)

7---Suffix

ISOLATED DC/DC CONVERTERS

36 Vdc - 80 Vdc Input, 3.3 Vdc/3 A Output



Aug. 13, 2010

Bel Power Inc., a subsidiary of Bel Fuse Inc.

Absolute Maximum Ratings

Parameter	Min	Typ	Max	Unit	Notes
Continuous non-operating Input Voltage	-0.3	-	85	V	
Transient Input Voltage	-	-	100	V	100mS
Remote On/Off	-0.3	-	18	V	
I/O Isolation Voltage	-	-	1500	V	
Ambient Temperature	-40	-	85	°C	
Storage Temperature	-55	-	125	°C	

Note: Ratings used beyond the maximum ratings may cause a reliability degradation of the converter or may permanently damage the device.

Input Specifications

Parameter	Min	Typ	Max	Unit	Notes
Operating Input Voltage	36	48	80	V	
Input Current (full load)	-	-	0.4	A	Test at 36Vdc
Input Current (no load)	-	20	30	mA	
Remote Off Input Current	-	5	10	mA	
Input Reflected Ripple Current (rms)	-	5	10	mA	With simulated source impedance of 10uH, 5Hz to 20MHz. Use a 100uF/100V electrolytic capacitor with ESR=1 ohm max, at 200KHz@25°C.
Input Reflected Ripple Current (pk-pk)	-	15	30	mA	
I ² t Inrush Current Transient	-	0.05	0.1	A ² s	
Turn-on Voltage Threshold	31	32	33	V	
Turn-off Voltage Threshold	30	31	32	V	
Other information:					
Input C-L-C filter	0.1uF+10uH+0.47uF				
Recommended input fast-acting fuse on system board		1		A	

CAUTION: This converter is not internally fused. An input line fuse must be used in application.

Note: All specifications are typical at 25 °C unless otherwise stated.

Output Specifications

Parameter	Min	Typ	Max	Unit	Notes
Output Voltage Set Point	3.234	3.3	3.366	V	Vin=48V, Io=50% load
Load Regulation	-	±6	±10	mV	
Line Regulation	-	±3	±6	mV	
Regulation Over Temperature (-40deg.C-85deg.C)	-	±33	±60	mV	
Total Output Voltage Variation	-	3	5	V%	Over all line, load & temperature conditions
Ripple and Noise (pk-pk)	-	70	120	mV	0-20MHz BW, with a 1µF ceramic capacitor and a 10uF Tantalum

ISOLATED DC/DC CONVERTERS

36 Vdc - 80 Vdc Input, 3.3 Vdc/3 A Output



Aug. 13, 2010

Bel Power Inc., a subsidiary of Bel Fuse Inc.

Output Specifications (continued)

Parameter	Min	Typ	Max	Unit	Notes	
Ripple and Noise (rms)	-	25	40	mV		
Output Current Range	0	-	3	A	this module is no need minimum load	
Output DC Current Limit	-	4	-	A		
Short Circuit Surge Transient	-	-	3	A ² s		
Rise Time	-	10	15	mS		
Turn on Time	-	20	30	mS	Ton(Enable form Vin)	
	-	20	30	mS	Ton(Enable form ON/OFF)	
Overshoot at Turn on	-	3	5	%		
Output Capacitance	0	-	1000	uF		
Transient Response						
ΔV 50%~75% of Max Load	Overshoot	-	150	-	mV	di/dt=0.1A/us, Vin=48Vdc, Ta=25°C, with a 1μF ceramic capacitor and a 10uF Tantalum cap at output.
	Settling Time	-	500	-	uS	
ΔV 75%~50% of Max Load	Overshoot	-	150	-	mV	
	Settling Time	-	500	-	uS	

Note: All specifications are typical at nominal input, full load at 25°C unless otherwise stated.

General Specifications

Parameter	Min	Typ	Max	Unit	Notes
Efficiency	-	82	-	%	Vin=48V, full load
Switching Frequency	-	300	-	kHz	
Output Voltage Trim Range	3.0	-	3.6	V	
Over Voltage Protection(Static)	-	4.5	-	V	This voltage is achieved by trimming up output slowly
Weight	-	TBD	-	g	
FIT	TBD			-	Calculated Per Bell Core SR-332 (Vin=48 V, Vo=3.3 V, Io=7 A, Ta = 25C, FIT=10 ⁹ /MTBF)
Dimensions	Inches (L x W x H) Millimeters (L x W x H)			-	1.10 x 0.96 x 0.335 27.94 x 24.38 x 8.50
Isolation characteristics					
Input to Output	-	-	1500	V	
Isolation Resistance	10M	-	-	ohm	
Isolation Capacitance	-	1500	-	pF	

Note: All specifications are typical at 25 °C unless otherwise stated.

ISOLATED DC/DC CONVERTERS

36 Vdc - 80 Vdc Input, 3.3 Vdc/3 A Output



Aug. 13, 2010

Bel Power Inc., a subsidiary of Bel Fuse Inc.

Efficiency Data

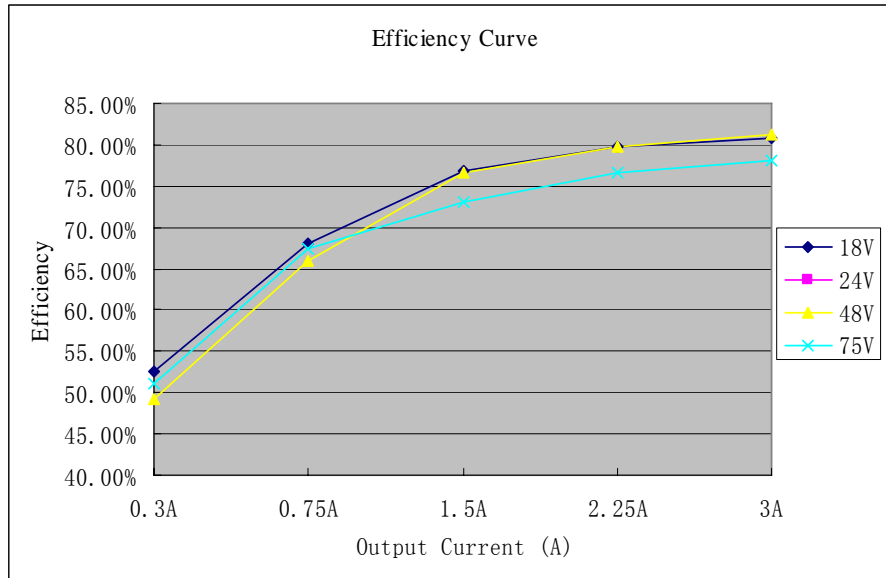

Thermal Derating Curve

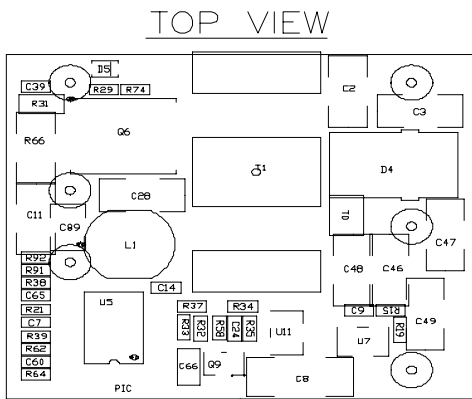

Forced Airflow Direction

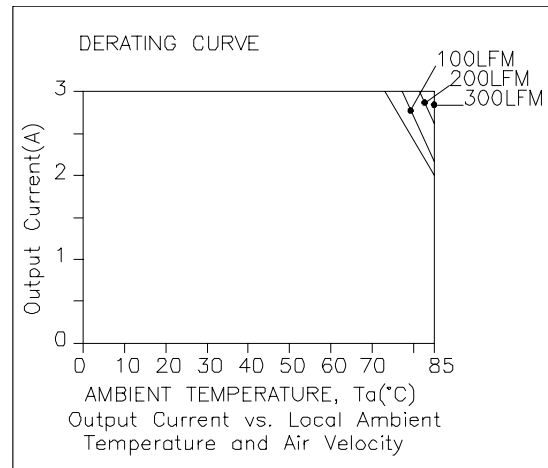

Vin=48V, with maximum junction temperature of semiconductors derated to 120C

ISOLATED DC/DC CONVERTERS

36 Vdc - 80 Vdc Input, 3.3 Vdc/3 A Output



Aug. 13, 2010

Bel Power Inc., a subsidiary of Bel Fuse Inc.

Thermal Derating Curve (continued)

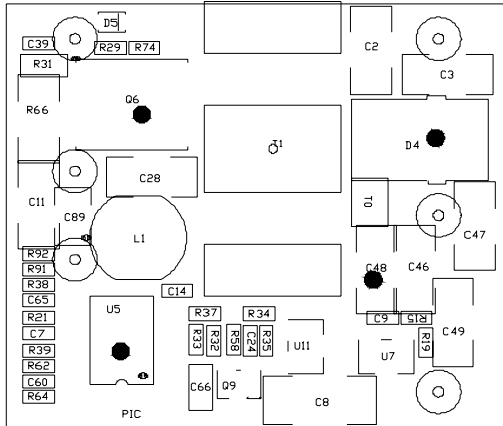

TOP VIEW

Temperature reference points on top side

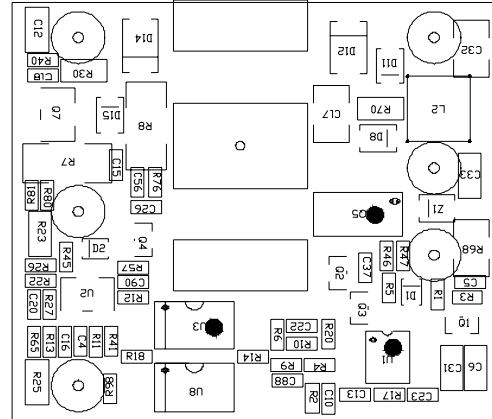

BOTTOM VIEW

Temperature reference points on bottom side

Ripple and Noise Waveforms

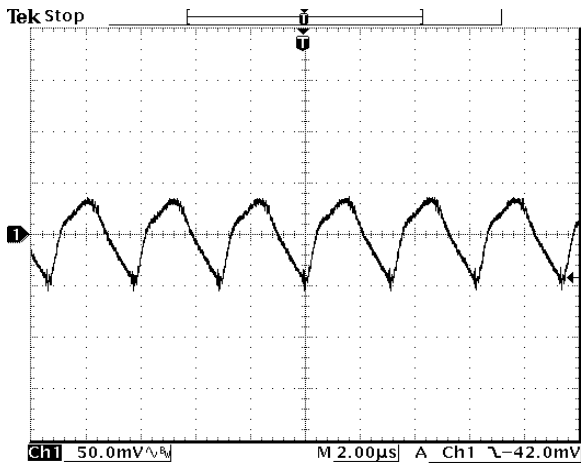

36 Vdc input, 3.3 Vdc/3 A output

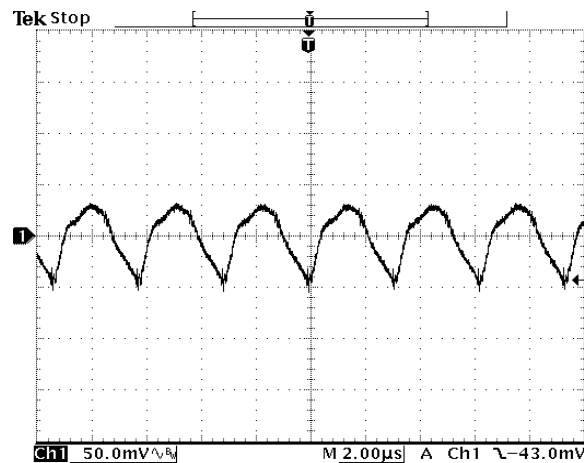

48 Vdc input, 3.3 Vdc/3 A output

ISOLATED DC/DC CONVERTERS

36 Vdc - 80 Vdc Input, 3.3 Vdc/3 A Output



Aug. 13, 2010

Bel Power Inc., a subsidiary of Bel Fuse Inc.

Ripple and Noise Waveforms (continued)

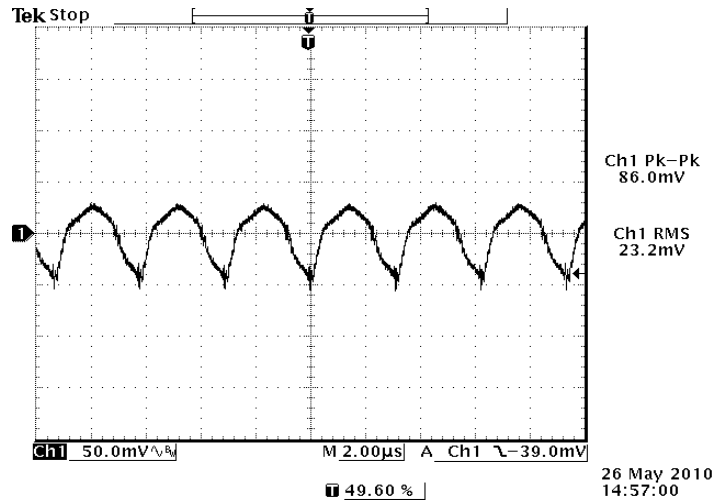

80 Vdc input, 3.3 Vdc/3 A output

Note: Ripple and noise at full load, 0-20MHz BW, with a 1µF ceramic cap and a 10 µF Tantalum cap at output, and $T_a=25$ deg C.

Transient Response Waveforms

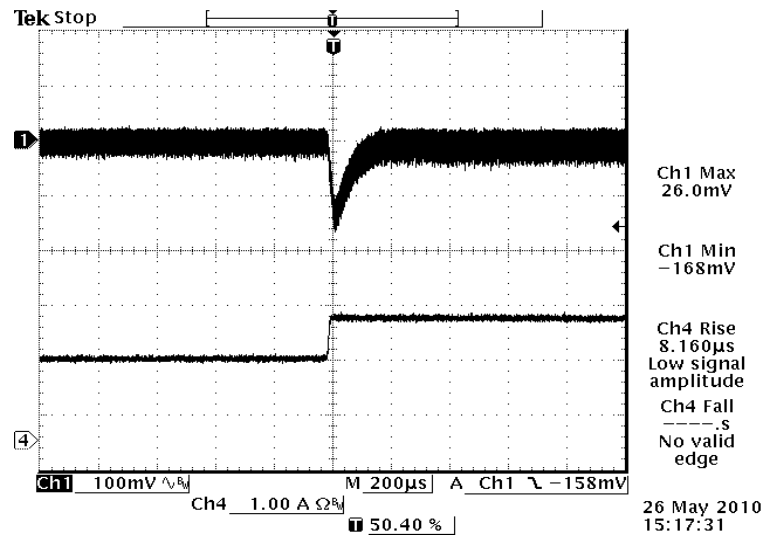

$V_{out}=3.3$ V, 50% to 75% Load Transients

ISOLATED DC/DC CONVERTERS

36 Vdc - 80 Vdc Input, 3.3 Vdc/3 A Output



Aug. 13, 2010

Bel Power Inc., a subsidiary of Bel Fuse Inc.

Transient Response Waveforms (continued)

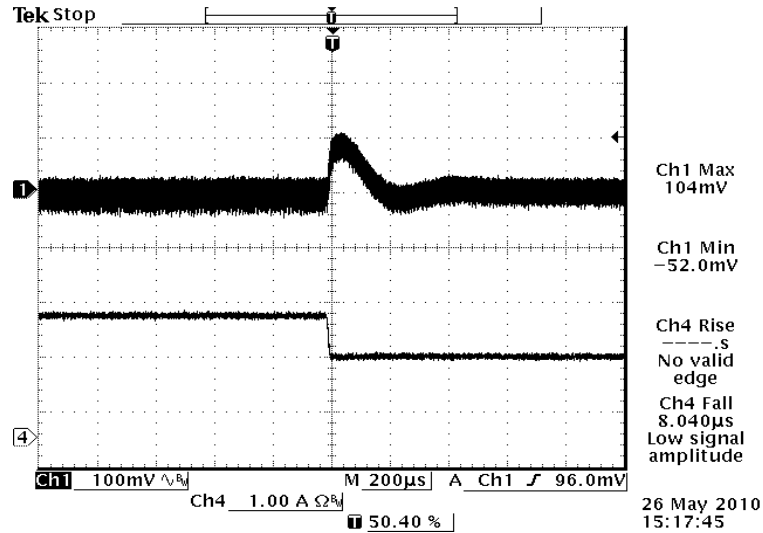

Vout=12 V, 75% to 50% Load Transients

Note: Transient response at Vin=48V Ta=25 deg C, and with a 1uF ceramic cap and a 10 uF Tantalum cap at output.

Startup & Shutdown

Rise Time

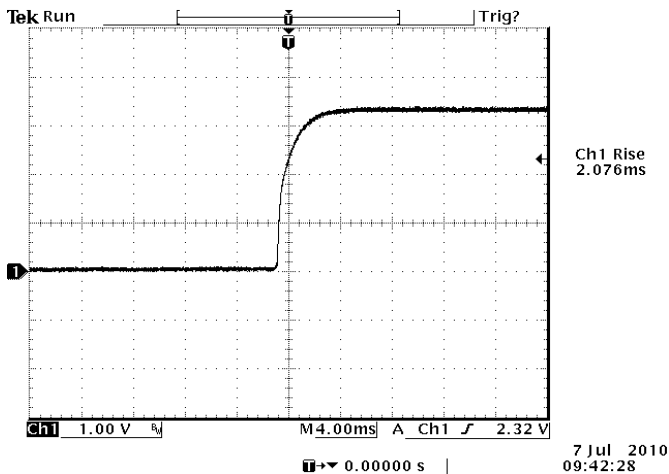

Vout= 3.3V full load at Vin=48V@Ta=25°C

ISOLATED DC/DC CONVERTERS

36 Vdc - 80 Vdc Input, 3.3 Vdc/3 A Output



Aug. 13, 2010

Bel Power Inc., a subsidiary of Bel Fuse Inc.

Startup & Shutdown (continued)

Startup time

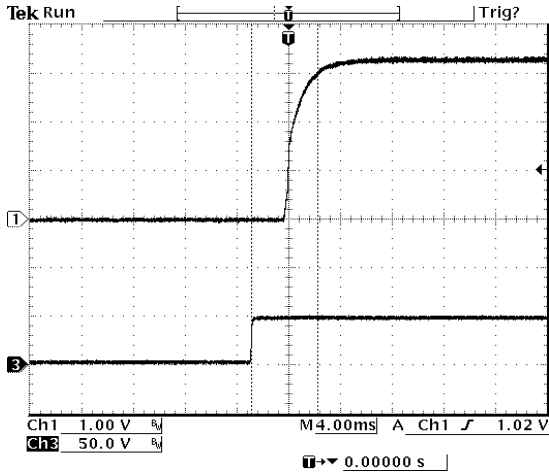

Startup from Vin
Ch1: Vo
Ch3: Vin
Vout= 3.3V full load at Vin=48V@Ta=25°C

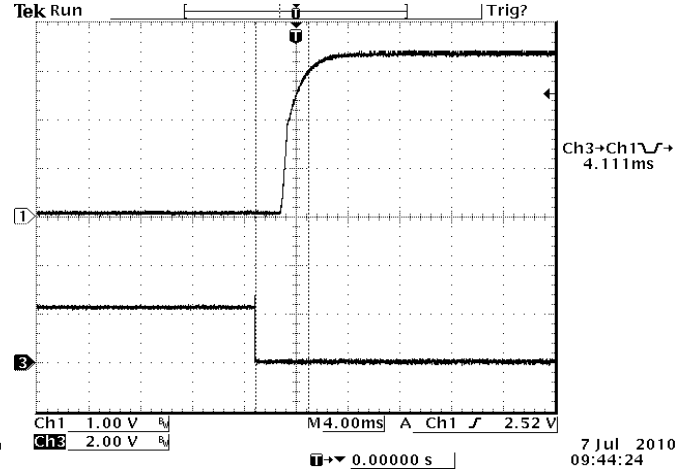

Startup from on/off
Ch1: Vo
Ch3: on/off
Vout= 3.3V full load at Vin=48V@Ta=25°C

Shutdown

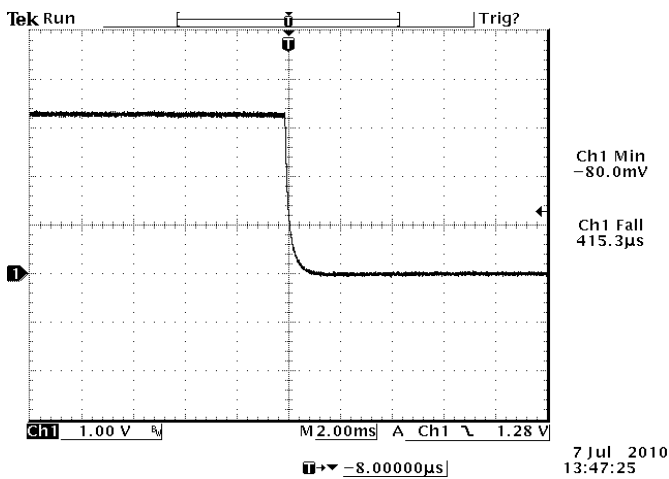

Vout= 3.3V full load at Vin=48V@Ta=25°C

ISOLATED DC/DC CONVERTERS

36 Vdc - 80 Vdc Input, 3.3 Vdc/3 A Output



Aug. 13, 2010

Bel Power Inc., a subsidiary of Bel Fuse Inc.

Remote On/Off

Parameter		Min	Typ	Max	Unit	Notes
Signal Low (Unit On)	Active Low	-0.3	-	0.8	V	The remote on/off pin open, Unit off.
Signal High (Unit Off)		2.4	-	18	V	
Signal Low (Unit Off)	Active High	-0.3	-	0.8	V	The remote on/off pin open, Unit on.
Signal High (Unit On)		2.4	-	18	V	
Current Sink		0	-	0.75	mA	

Recommended remote on/off circuit for active low

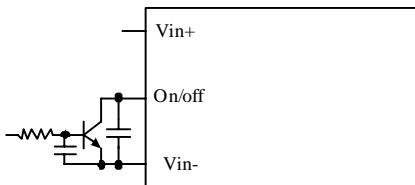

Control with open collector/drain circuit

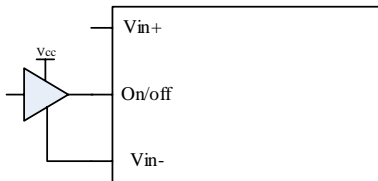

Control with logic circuit

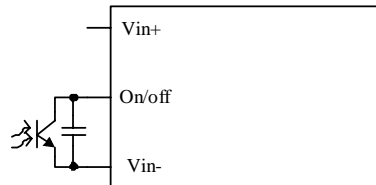

Control with photocoupler circuit

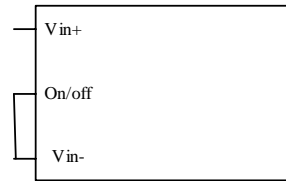

Permanently on

Recommended remote on/off circuit for active high

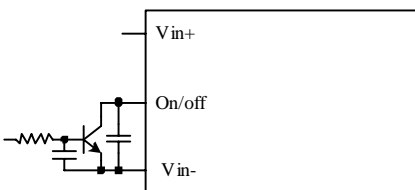

Control with open collector/drain circuit

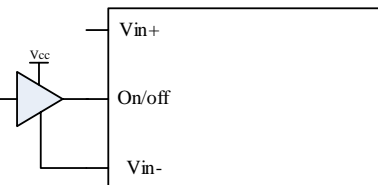

Control with logic circuit

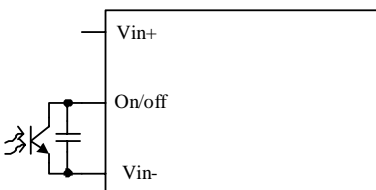

Control with photocoupler circuit

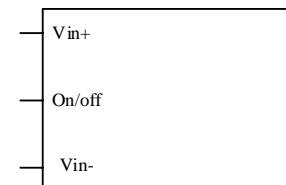

Permanently on

ISOLATED DC/DC CONVERTERS

36 Vdc - 80 Vdc Input, 3.3 Vdc/3 A Output



Aug. 13, 2010

Bel Power Inc., a subsidiary of Bel Fuse Inc.

Output Trim Equations

Equations for calculating the trim resistor are shown below. The Trim Down resistor should be connected between the Trim pin and Vout pin. The Trim Up resistor should be connected between the Trim pin and the GND pin. Only one of the resistors should be used for any given application.

Minimum trim down voltage is 3.0V

Maximum trim up voltage is 3.6V.

The total voltage increased by trim and remote sense should not exceed 10% of the nominal output voltage.

$$R_{trimdown} = 20.525 \cdot \frac{(V_o_req - 1.24)}{3.3 - V_o_req} - 1 [k\Omega]$$

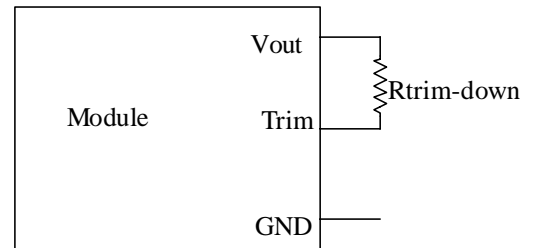

$$R_{trimup} = \frac{25.451}{V_o_req - 3.3} - 1 [k\Omega]$$

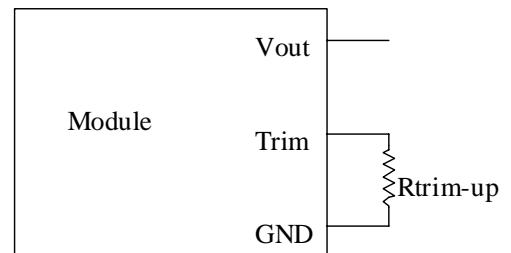

Note: Vo_req=Desired (trimmed) output voltage[V]

Output voltage Vo=3.3 V

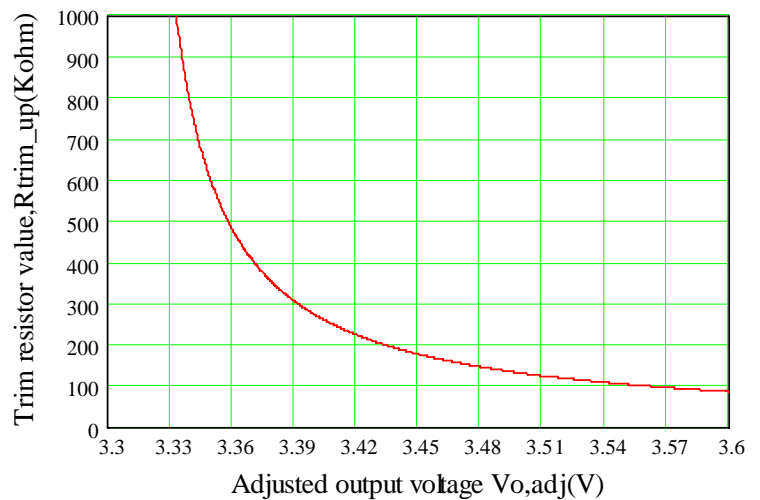
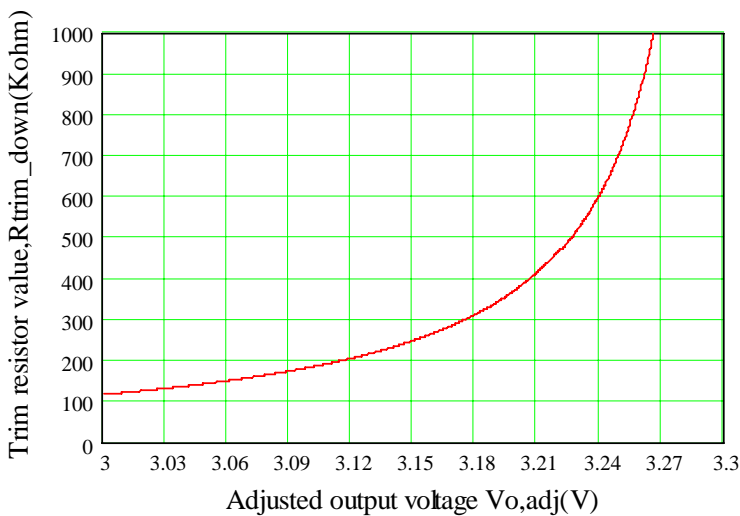

ISOLATED DC/DC CONVERTERS

36 Vdc - 80 Vdc Input, 3.3 Vdc/3 A Output



Aug. 13, 2010

Bel Power Inc., a subsidiary of Bel Fuse Inc.

Over Current Protection

To provide protection in a fault output overload condition, the module is equipped with internal current-limiting circuitry and can endure current limiting for a few milli-seconds. If the over-current condition persists beyond a few milliseconds, the module will shut down into hiccup mode and restart once every 400mS. The module operates normally when the output current goes into specified range. The typical average output current is 5A during hiccup.

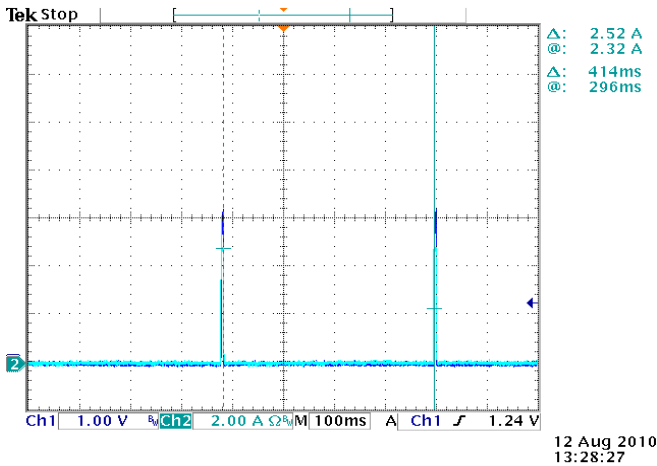

CH1: Output voltage waveform
 CH2: Output current waveform
 Test condition: 48V input with a Rout (0.171ohm)

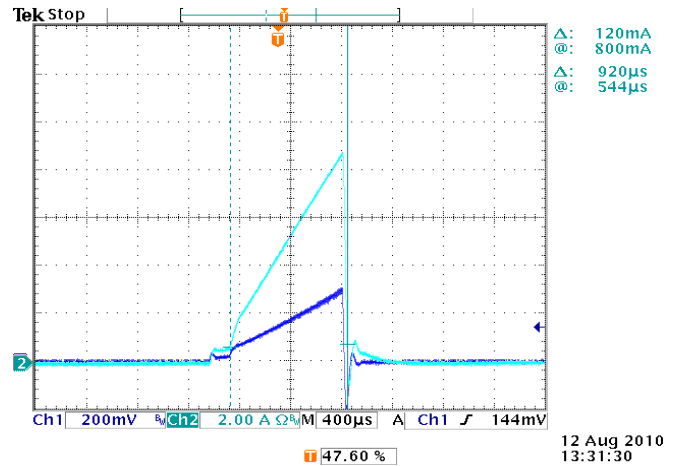

CH1: Output voltage waveform
 CH2: Output current waveform
 Test condition: 48V input with a Rout (0.171ohm)
 Expansion of on time portion of above figure

Over Voltage Protection

The output overvoltage protection consists of circuitry that monitors the voltage on the output terminals. If the voltage on the output terminals exceeds the over voltage protection threshold, the module will shutdown into hiccup mode and restart once every 400mS. The module operates normally when the fault is cleared.

Test setup:

R=22K

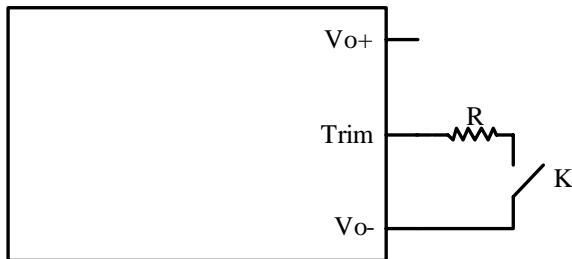

Waveform:

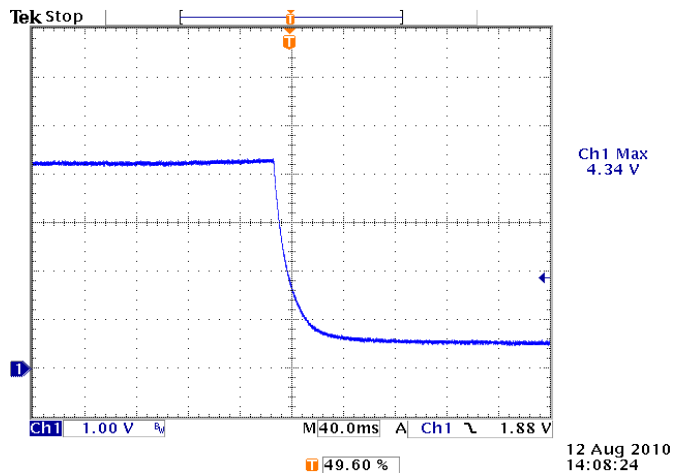

CH1: Output voltage waveform

ISOLATED DC/DC CONVERTERS

36 Vdc - 80 Vdc Input, 3.3 Vdc/3 A Output



Aug. 13, 2010

Bel Power Inc., a subsidiary of Bel Fuse Inc.

Input Under Voltage Lockout

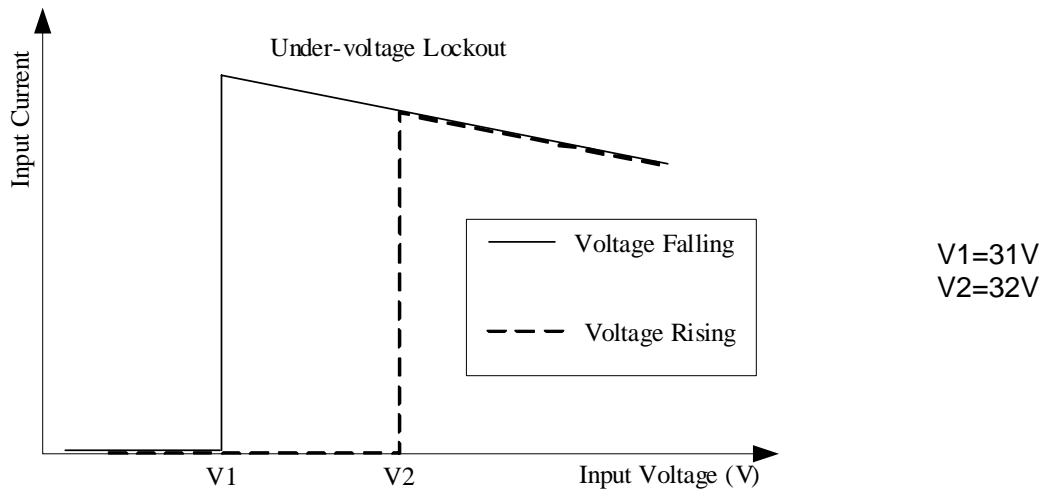

Fundamental Circuit Diagram

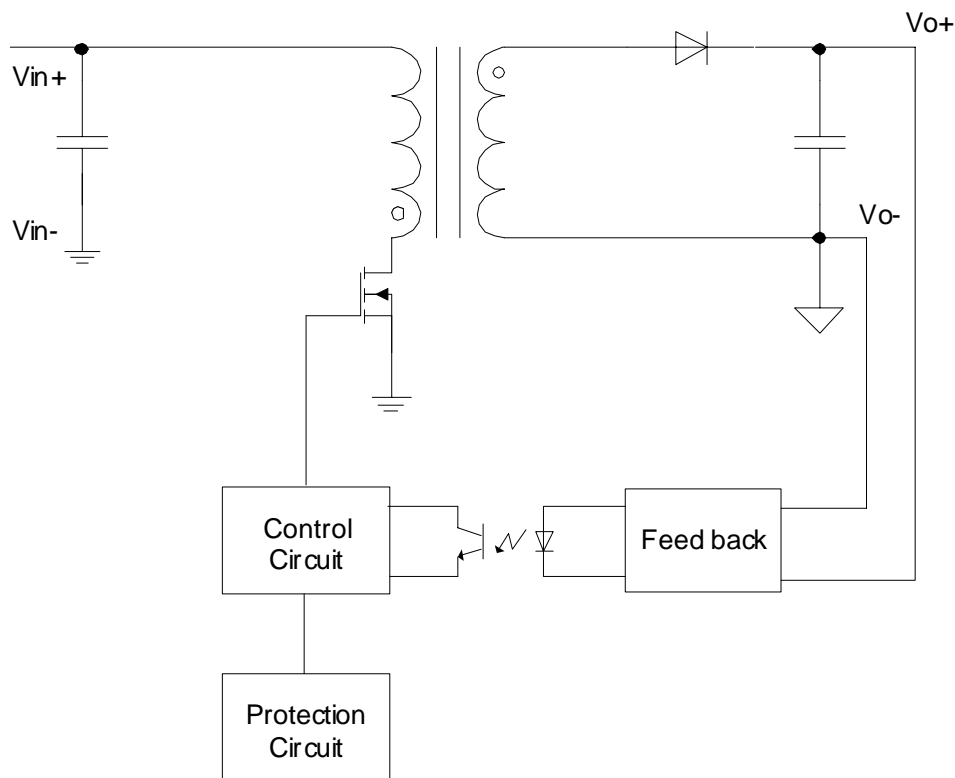

ISOLATED DC/DC CONVERTERS

36 Vdc - 80 Vdc Input, 3.3 Vdc/3 A Output



Aug. 13, 2010

Bel Power Inc., a subsidiary of Bel Fuse Inc.

Safety & EMC

Safety

1. Material flammability UL94V-0
2. TUV Certification EN60950-1
3. UL Certification UL60950-1

EMC

1. Surge IEC61000-4-5
2. DC-DIP IEC61000-4-29
3. Conductive EMI EN55022 class A

Compliance to EN55022 class A (both q.peak and average) with the following inductive and capacitive filter

Setup:

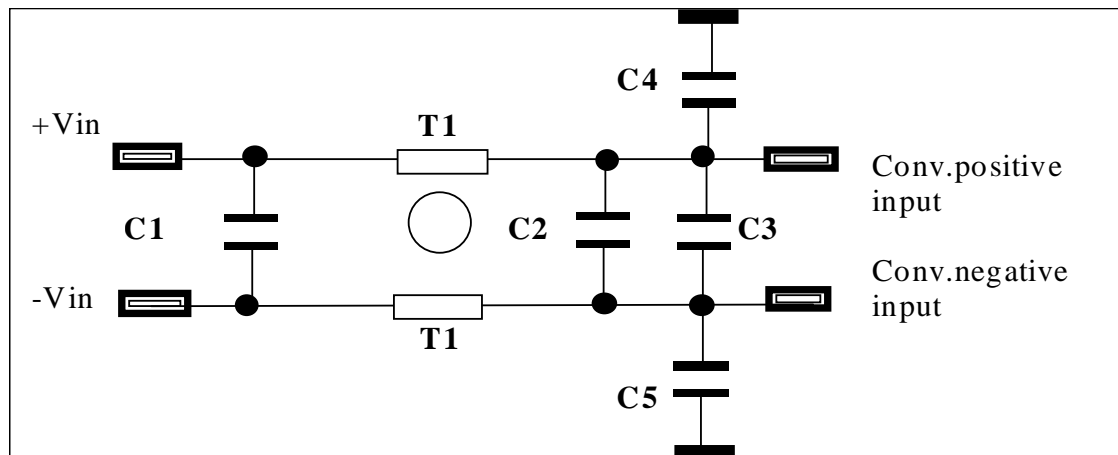

Item	Designator	Parameter	Vendor	Vendor P/N
1	C1	2.2uF/100V,ceramic	Murata	GRF32ER72A225KA11L
2	C2	47uF/100V, AL cap	Nichicon	UJJ2A470MNL1MS
3	C3	100uF/100V, AL cap	Nichicon	UVZ2A101MPD
4	C4	1000pF/2000V,ceramic	Johanson	202R18W102KV4E-****-RC
5	C5	1000pF/2000V,ceramic	Johanson	202R18W102KV4E-****-RC
6	T1	1.3mH, common mode	Pulse	P0402NL

ISOLATED DC/DC CONVERTERS

36 Vdc - 80 Vdc Input, 3.3 Vdc/3 A Output



Aug. 13, 2010

Bel Power Inc., a subsidiary of Bel Fuse Inc.

Mechanical Outline

ORLP-10T03x

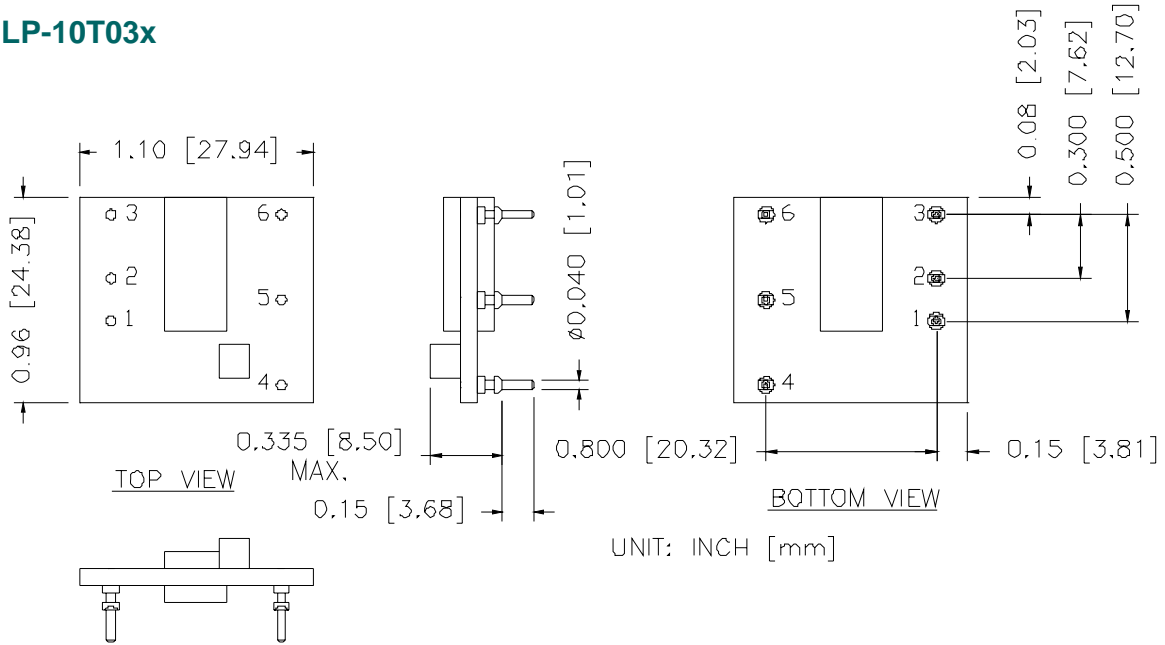

RECOMMENDED PAD LAYOUT

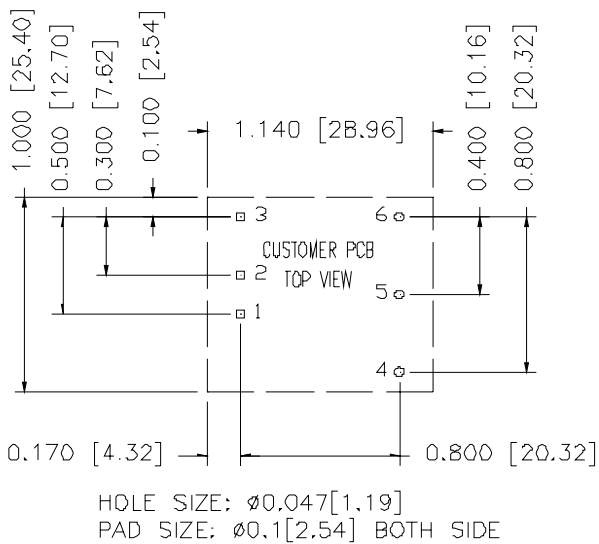

Pin	Name	Function	Dia.
1	Vin(+)	Positive input voltage	0.04"
2	Vin(-)	Negative input voltage	0.04"
3	On/Off	Input to turn converter on and off, referenced to Vin(-)	0.04"
4	Vout(+)	Positive output voltage	0.04"
5	Trim	Output voltage trim	0.04"
6	Vout(-)	Negative output voltage	0.04"

Note: Leave Pin 6 open for nominal voltage.

ISOLATED DC/DC CONVERTERS

36 Vdc - 80 Vdc Input, 3.3 Vdc/3 A Output



Aug. 13, 2010

Bel Power Inc., a subsidiary of Bel Fuse Inc.

SRLP-10T03x

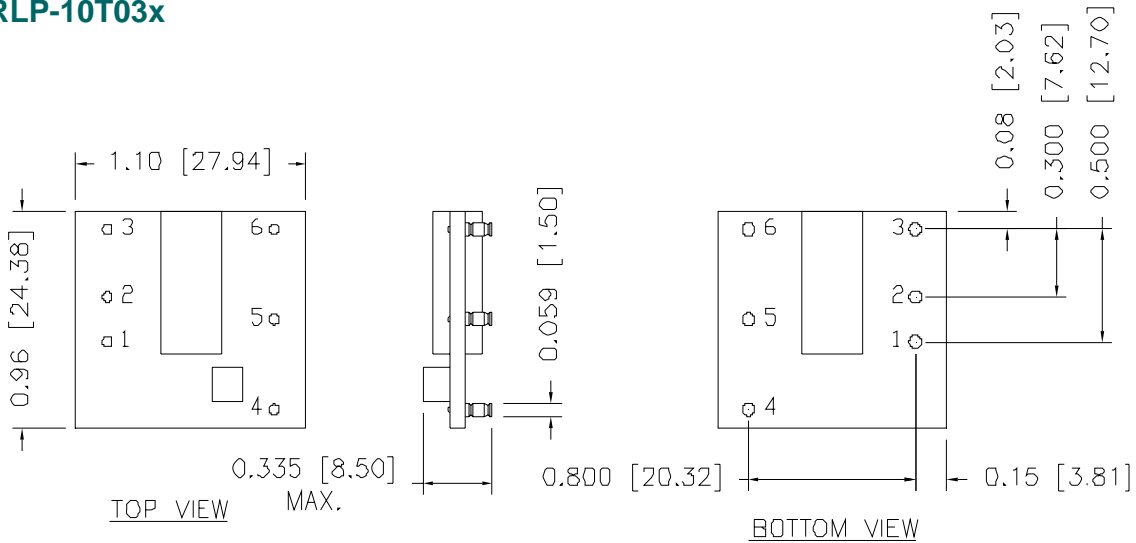

RECOMMENDED PAD LAYOUT

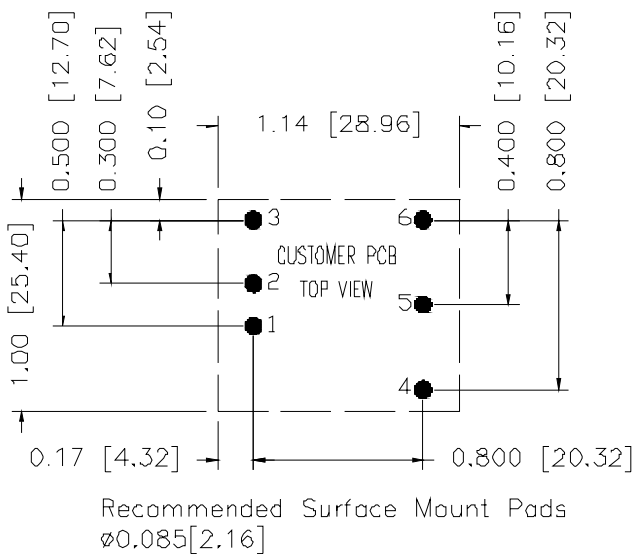

Pin	Name	Function	Dia.
1	Vin(+)	Positive input voltage	0.06"
2	Vin(-)	Negative input voltage	0.06"
3	On/Off	Input to turn converter on and off, referenced to Vin(-)	0.06"
4	Vout(+)	Positive output voltage	0.06"
5	Trim	Output voltage trim	0.06"
6	Vout(-)	Negative output voltage	0.06"

Note: Leave Pin 6 open for nominal voltage.

Note: This module is recommended and compatible with Pb-Free Wave Soldering and must be soldered using a peak solder temperature of no more than 260 °C for less than 5 seconds.

Note:

- All Pins: Material - Copper Alloy;
Finish – 3 micro inches minimum Gold over 50 micro inches minimum Nickel plate.
- Undimensioned components are shown for visual reference only.
- All dimensions in inches (mm); Tolerances: x.xx +/-0.02 in. (x.x +/-0.5mm) x.xxx +/-0.010 in. (x.xx +/-0.25mm).

ISOLATED DC/DC CONVERTERS

36 Vdc - 80 Vdc Input, 3.3 Vdc/3 A Output



Aug. 13, 2010

Bel Power Inc., a subsidiary of Bel Fuse Inc.

Revision History

Date	Revision	Changes Detail	Approval
2010-04-06	PA	First release	XF Jiang
2010-06-09	PB	Updated Input C-L-C filter, Efficiency Data, NR, TR, Trim, UVLO, MD and SCH	XF Jiang
2010-08-13	PC	Add TD, Startup&Shutdown, OCP, OVP, Fundamental circuit diagram, Safety&EMC and chart of output trim	XF Jiang

RoHS Compliance

Complies with the European Directive 2002/95/EC, calling for the elimination of lead and other hazardous substances from electronic products.



©2010 Bel Fuse Inc. Specifications subject to change without notice. 081310

CORPORATE

Bel Fuse Inc.
206 Van Vorst Street
Jersey City, NJ 07302
Tel 201-432-0463
Fax 201-432-9542
www.belfuse.com

FAR EAST

Bel Fuse Ltd.
8F/ 8 Luk Hop Street
San Po Kong
Kowloon, Hong Kong
Tel 852-2328-5515
Fax 852-2352-3706
www.belfuse.com

EUROPE

Bel Fuse Europe Ltd.
Preston Technology Management Centre
Marsh Lane, Suite G7, Preston
Lancashire, PR1 8UD, U.K.
Tel 44-1772-556601
Fax 44-1772-888366
www.belfuse.com