

# POWER RELAY

## 1 POLE - 15A

### VS-NR Series

#### ■ FEATURES

- UL, CSA, VDE, SEV, SEMKO, CQC recognized
  - TV-8 is available
  - Working class: C
  - UL class B (130°C) wire class
  - Type of service: continuous duty
  - Heavy duty miniature slim type power relay
  - High insulation in small package
    - Insulation distance: 8 mm
    - Dielectric strength: 5,000 VAC (between coil and contacts)
    - Surge strength: 10,000 V
  - Standard and high sensitive types available
  - Flux free type and plastic sealed type available
  - Cadmium free type
  - RoHS compliant.
- Please see page 7 for more information



#### ■ PARTNUMBER INFORMATION

[Example]  $\frac{VS}{(a)} - \frac{12}{(*)} \frac{S}{(b)} \frac{M}{(c)} \frac{B}{(d)} \frac{U}{(e)} - \frac{NR}{(g)} - \frac{UC}{(h)}$

(a)	Relay type	VS	: VS Series
(b)	Coil rated voltage	12	: 3....100VDC Coil rating table at page 3
(c)	Coil type	Nil S	: Standard type (700-750mW) : High sensitive type (530mW)
(d)	Contact configuration	M	: 1 form A (SPST-NO)
(e)	Enclosure	B C K	: Flux proof type, RTII : Plastic sealed type (with tape), RTIII : Plastic sealed type, RTIII
(f)	TV type	Nil U	: TV rating type : Non TV rating type (standard type)
(g)	Contact material	NR	: Silver alloy (AgSnO InO)
(h)	Safety standard	UC SM2 IM2	: UL, CSS : UL, CSA, VDE, SEMKO : UL, CSA, VDE, SEV, SEMKO

Note: Actual marking omits the hyphen (-) of (\*)  
Marking example: VS-12MBU-NR

# VS-NR SERIES

## ■ SPECIFICATION

		TV-8 rating type	Standard	
		VS - ( ) M - NR	VS - ( ) MU - NR	
Contact Data	Configuration		1 form A (SPST-NO)	
	Construction		Single	
	Material		Silver alloy (AgSnO InO)	
	Resistance (initial)		Max. 100mOhm at 6VDC, 1A	
	Contact rating		15A, 240VAC / 24VDC	
	Max. carrying current *1		15A	
	Max. switching voltage		250VAC, 150 VDC	
	Max. switching power		1,800VA, 360W	
	Max. inrush current (at lamp load)		117A, 120VAC	-
	Min. switching load *2		100 mA, 5 VDC	
Life	Mechanical		Min. 20 x 10 <sup>6</sup> operations	
	Electrical	Contact rating	Min. 100 x 10 <sup>3</sup> operations (resistive)	
		Motor	Min. 50 x 10 <sup>3</sup> operations (at 1/4 HP 120VAC UL HP rating)	Min. 30 x 10 <sup>3</sup> operations (at 1/4 HP 120VAC UL HP rating)
		Lamp	Min. 25 x 10 <sup>3</sup> operations	
Coil Data	Rated power (at 20 °C)		Standard type: 700 to 750mW High sensitive type: 530mW	
	Operate power (at 20 °C)		Standard type: 350 - 370mW High sensitive type: 260mW	
	Operating temperature range		Standard type: -40 °C to +65 °C (no frost) High sensitive type: -40 °C to +75 °C (no frost)	
Timing Data	Operate (at nominal voltage)		Max. 15 ms (without bounce)	
	Release (at nominal voltage)		Max. 10 ms (no diode)	
Insulation	Resistance (initial)		Min. 1,000MOhm at 500VDC	
	Dielectric strength	Open contacts	1,000VAC (50/60Hz) 1min., 10mA detection current	
		Contacts to coil	5,000VAC (50/60Hz) 1min., 10mA detection current	
	Surge strength	Coil to contacts	10,000V, 1.2 x 50µs standard wave	
	Clearance		8 mm	
	Creepage		8 mm	
	EN61810-1, VDE0435	Voltage	250 V	
		Pollution degree	2	
	Material group	III		
Other	Vibration resistance	Misoperation	10 to 55Hz double amplitude 1.5 mm	
		Endurance	10 to 55Hz double amplitude 1.5 mm	
	Shock	Misoperation	Min. 100m/s <sup>2</sup> (11 ± 1ms)	
		Endurance	Min. 1,000m/s <sup>2</sup> (6 ± 1ms)	
	Weight		Approximately 17 g	

\*1 When max. carrying current is more than 10A, PCB layout needs to be considered.

\*2 Minimum switching loads mentioned above are reference values. Please perform the confirmation test with actual load before production since reference values may vary according to switching frequencies, environmental conditions and expected reliability levels.

# VS-NR SERIES

## ■ COIL RATING

Standard type

Coil Code	Rated Coil Voltage (VDC)	Coil Resistance +/- 10% (Ohm)	Must Operate Voltage (VDC) *1	Must Release-Voltage (VDC) *1	Max. Coil Voltage (VDC)	Rated Power (mW)
3	3	12.5	2.1	0.3	4.95	720
5	5	36	3.5	0.5	8.25	700
6	6	50	4.2	0.6	9.90	720
9	9	115	6.3	0.9	14.85	700
12	12	200	8.4	1.2	19.8	720
14	14	280	9.8	1.4	23.1	700
18	18	460	12.6	1.8	29.7	
24	24	820	16.8	2.4	39.6	
36	36	1,850	25.2	3.6	59.4	
48	48	3,300	33.6	4.8	79.2	
60	60	5,100	42	6	99	
100	100	13,400	70	10	165	750

High sensitive type (250 mW)

Coil Code	Rated Coil Voltage (VDC)	Coil Resistance +/- 10% (Ohm)	Must Operate Voltage (VDC) *1	Must Release-Voltage (VDC) *1	Max. Coil Voltage (VDC)	Rated Power (mW)
3	3	17	2.1	0.3	4.95	530
5	5	47	3.5	0.5	8.25	
6	6	68	4.2	0.6	9.90	
9	9	115	6.3	0.9	14.85	
12	12	270	8.4	1.2	19.8	
14	14	370	9.8	1.4	23.1	
18	18	610	12.6	1.8	29.7	
24	24	1,000	16.8	2.4	39.6	
36	36	2,450	25.2	3.6	59.4	
48	48	4,400	33.6	4.8	79.2	
60	60	6,800	42	6	99	
100	100	18,860	70	10	165	

Note: All values in the table are valid for 20°C and zero contact current.

\* Specified operate values are valid for pulse wave voltage.

# VS-NR SERIES

## SAFETY STANDARDS

Type	Compliance	Contact rating
UL	UL 508	Flammability: UL 94-V0 (plastics)
	E 56140	Isolation: classB 10A, 240VAC(resistive)
CSA	C22.2 No. 14	1/2 hp, 240VAC/120VAC
	LR 35579	1/3 hp, 120VAC / 240VAC Pilot duty: B150 [TV-8] 15A, 120VAC/24VDC (resistive) 1/3 hp, 240VAC/120VAC
VDE	DIN EN 61810-1 0435 part 201 40014665	15A 250VAC (cosφ=1) 4.3A 250VAC (cos=0.4) 15A 24VDC (0ms) 15A/120VAC, 250VAC

Also complies with SEV, SEMKO, NEMKO, DEMKO, FIMKO, CQC

## CHARACTERISTIC DATA

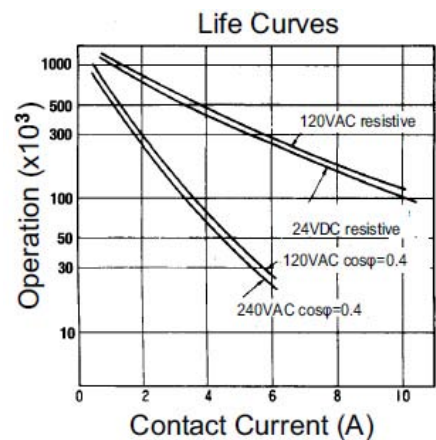
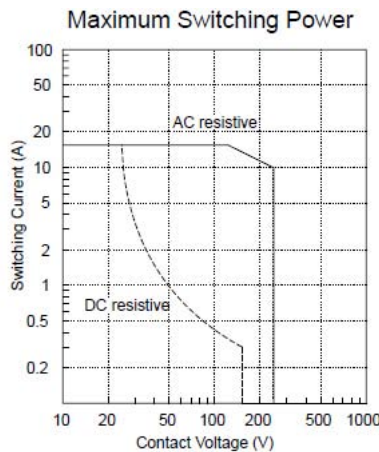
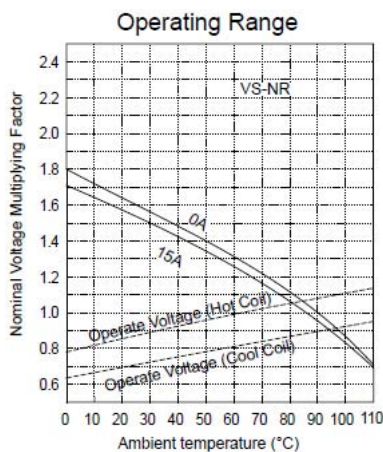
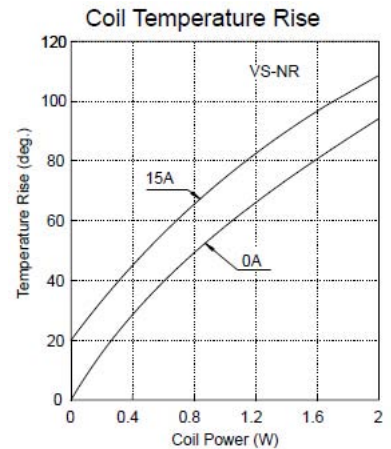
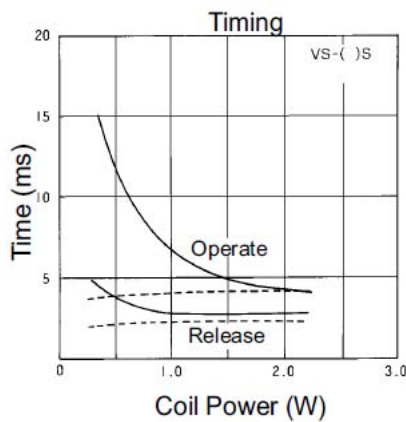
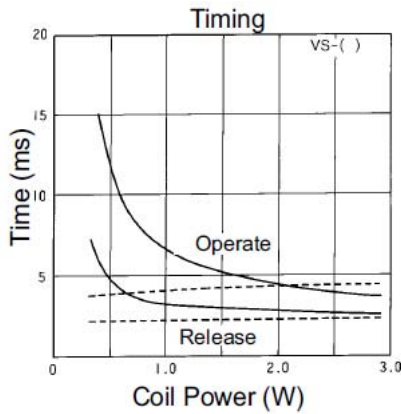

# VS-NR SERIES

## ■ REFERENCE DATA

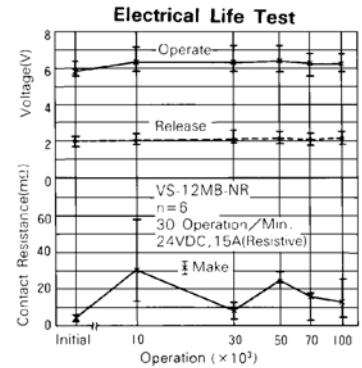
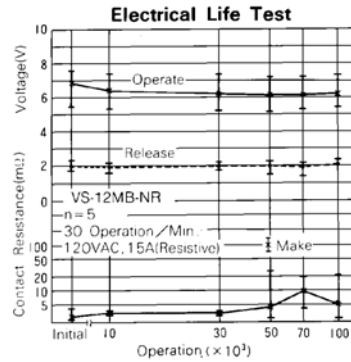
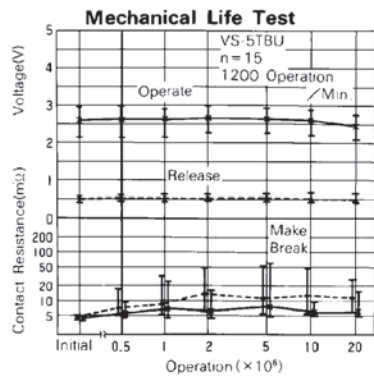
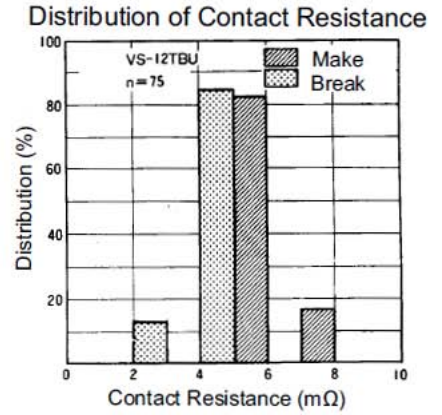
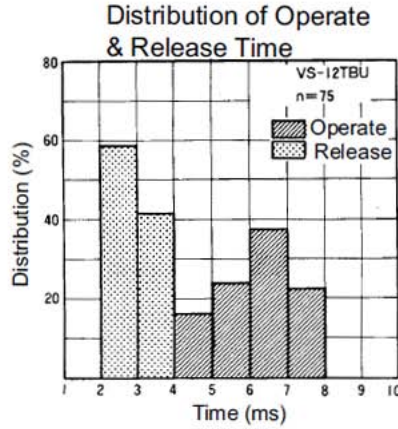
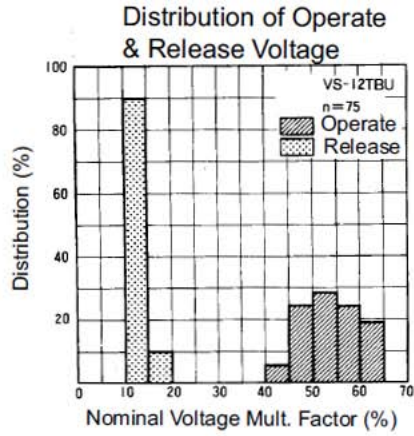

# VS-NR SERIES

## ■ DIMENSIONS

- Dimensions

VS-MB-NR type flux proof type

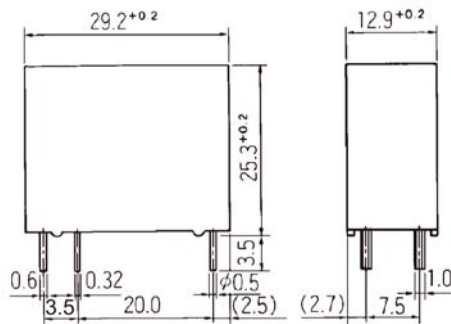

- Schematics (BOTTOM VIEW)

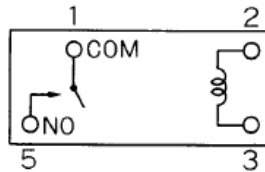

- PC board mounting hole layout (BOTTOM VIEW)

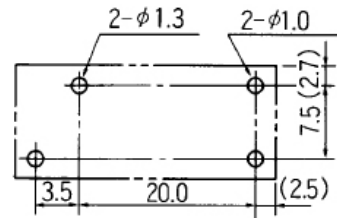

VS-MC-NR type (plastic sealed type with tape)

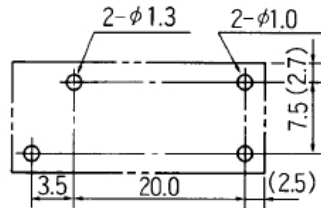
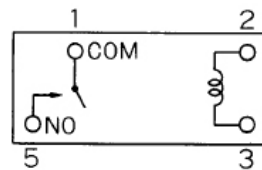
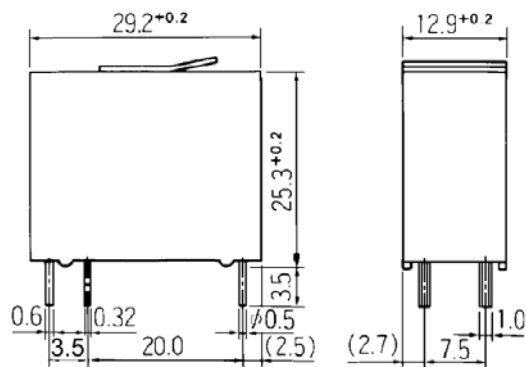

VS-MK-NR type (Plastic sealed type)

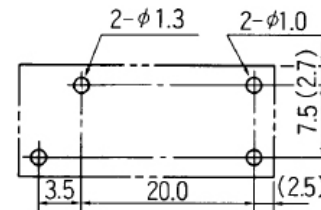
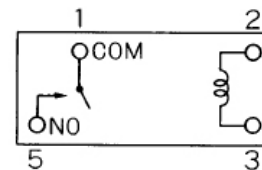
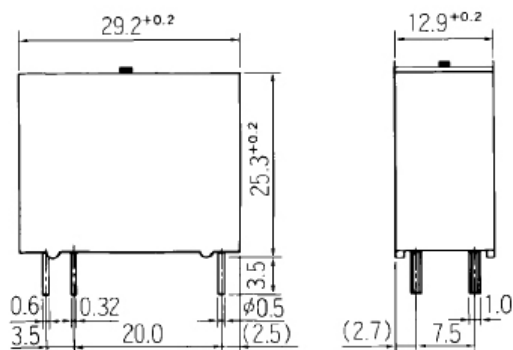

Unit: mm

## RoHS Compliance and Lead Free Information

### 1. General Information

- All signal and power relays produced by Fujitsu Components are compliant with RoHS directive 2002/95EC including amendments.
- Cadmium as used in electrical contacts is exempted from the RoHS directives on October 21st, 2005. (Amendment to Directive 2002/95/EC)
- All of our signal and power relays are lead-free. Please refer to Lead-Free Status Info for older date codes at: <http://www.fujitsu.com/us/downloads/MICRO/fcai/relays/lead-free-letter.pdf>
- Lead free solder plating on relay terminals is Sn-3.0Ag-0.5Cu, unless otherwise specified. This material has been verified to be compatible with PbSn assembly process.

### 2. Recommended Lead Free Solder Profile

- Recommended solder Sn-3.0Ag-0.5Cu.

**Flow Solder condition:**

Pre-heating: maximum 120°C  
Soldering: dip within 5 sec. at  
260°C solder bath

**Solder by Soldering Iron:**

Soldering Iron  
Temperature: maximum 360°C  
Duration: maximum 3 sec.

**We highly recommend that you confirm your actual solder conditions**

### 3. Moisture Sensitivity

- Moisture Sensitivity Level standard is not applicable to electromechanical relays, unless otherwise indicated.

### 4. Tin Whiskers

- Dipped SnAgCu solder is known as presenting a low risk to tin whisker development. No considerable length whisker was found by our in house test.



## Fujitsu Components International Headquarter Offices

### Japan

Fujitsu Component Limited  
Gotanda-Chuo Building  
3-5, Higashigotanda 2-chome, Shinagawa-ku  
Tokyo 141, Japan  
Tel: (81-3) 5449-7010  
Fax: (81-3) 5449-2626  
Email: [promothq@ft.ed.fujitsu.com](mailto:promothq@ft.ed.fujitsu.com)  
Web: [www.fcl.fujitsu.com](http://www.fcl.fujitsu.com)

### North and South America

Fujitsu Components America, Inc.  
250 E. Caribbean Drive  
Sunnyvale, CA 94089 U.S.A.  
Tel: (1-408) 745-4900  
Fax: (1-408) 745-4970  
Email: [components@us.fujitsu.com](mailto:components@us.fujitsu.com)  
Web: <http://us.fujitsu.com/components>

### Europe

Fujitsu Components Europe B.V.  
Diamantlaan 25  
2132 WV Hoofddorp  
Netherlands  
Tel: (31-23) 5560910  
Fax: (31-23) 5560950  
Email: [info@fceu.fujitsu.com](mailto:info@fceu.fujitsu.com)  
Web: [emea.fujitsu.com/components/](http://emea.fujitsu.com/components/)

### Asia Pacific

Fujitsu Components Asia Ltd.  
102E Pasir Panjang Road  
#01-01 Citilink Warehouse Complex  
Singapore 118529  
Tel: (65) 6375-8560  
Fax: (65) 6273-3021  
Email: [fcal@fcal.fujitsu.com](mailto:fcal@fcal.fujitsu.com)  
Web: <http://www.fujitsu.com/sg/services/micro/components/>

©2011 Fujitsu Components Europe B.V. All rights reserved. All trademarks or registered trademarks are the property of their respective owners.

The contents, data and information in this datasheet are provided by Fujitsu Component Ltd. as a service only to its user and only for general information purposes.

The use of the contents, data and information provided in this datasheet is at the users' own risk.

Fujitsu has assembled this datasheet with care and will endeavor to keep the contents, data and information correct, accurate, comprehensive, complete and up to date.

Fujitsu Components Europe B.V. and affiliated companies do however not accept any responsibility or liability on their behalf, nor on behalf of its employees, for any loss or damage, direct, indirect or consequential, with respect to this datasheet, its contents, data, and information and related graphics and the correctness, reliability, accuracy, comprehensiveness, usefulness, availability and completeness thereof.

Nor do Fujitsu Components Europe B.V. and affiliated companies accept on their behalf, nor on behalf of its employees, any responsibility or liability for any representation or warrant of any kind, express or implied, including warranties of any kind for merchantability or fitness for particular use, with respect to these datasheets, its contents, data, information and related graphics and the correctness, reliability, accuracy, comprehensiveness, usefulness, availability and completeness thereof. Rev. March 02, 2011