

Part/Keyword Search



Detailed Drawing



Printer Friendly Datasheet

PN6558 / SPN6558*

* Part number for additional environmental screening.

Performance Data

Frequency	5.0 - 500.0 MHz
Gain	12.0 dB Typical 10.5 dB Min
Noise Figure	4.8 dB Typical 6.5 dB Max
P _{1dB}	19.0 dBm Typical 17.5 dBm Min
3 rd Order Intercept	36.0 dBm Typical
2 nd Order Intercept	48.0 dBm Typical
VSWR	1.5/2.0 Input Typ/Max 1.5/2.0 Output Typ/Max
Reverse Isolation	-16.0 dB Typical -15.0 dB Min
Power Supply	15.0 Volts 65.0 mA
Operating Temperature	-55.0 - 85.0 °C

Package Drawing

SM-11 (Surface Mount)

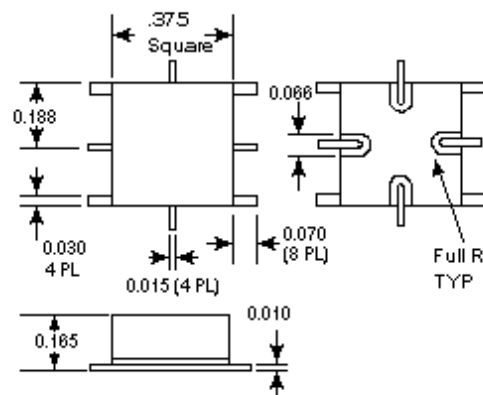

Gain

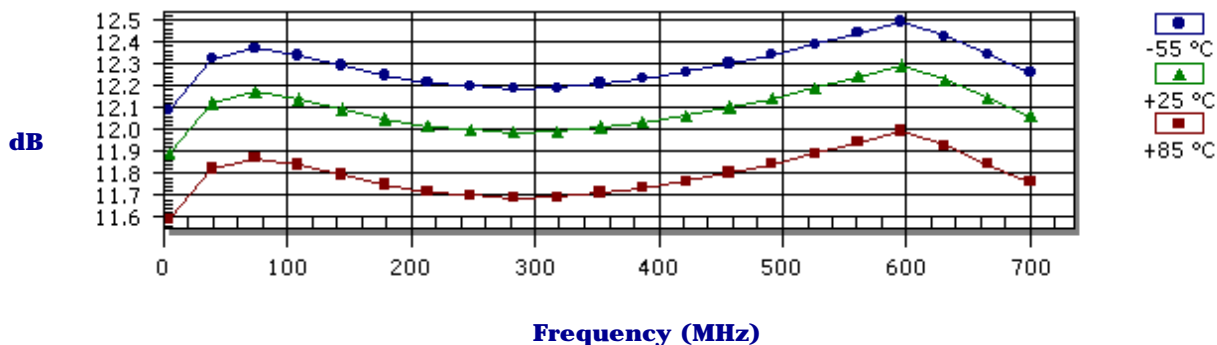

Noise Figure

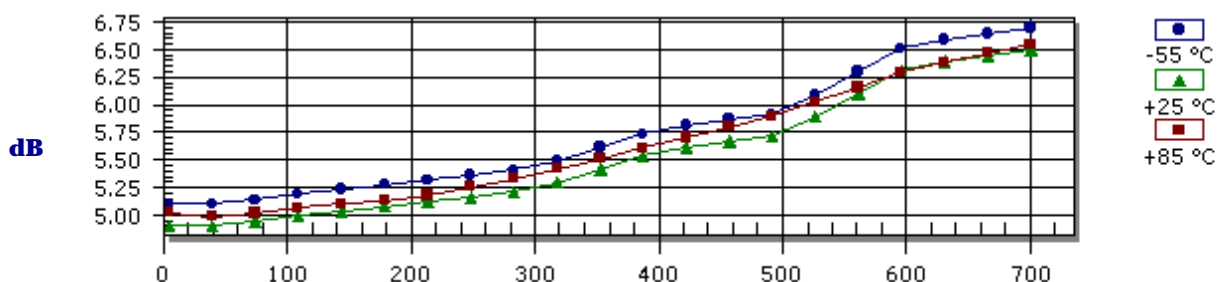

- Products
- Amplifiers
- VCOs
- Limiting Amplifiers
- Switches
- Linearizers
- Limiters
- Analog Attenuators
- Digital Attenuators
- Detectors

Frequency (MHz)

P_{1dB} Compression Point

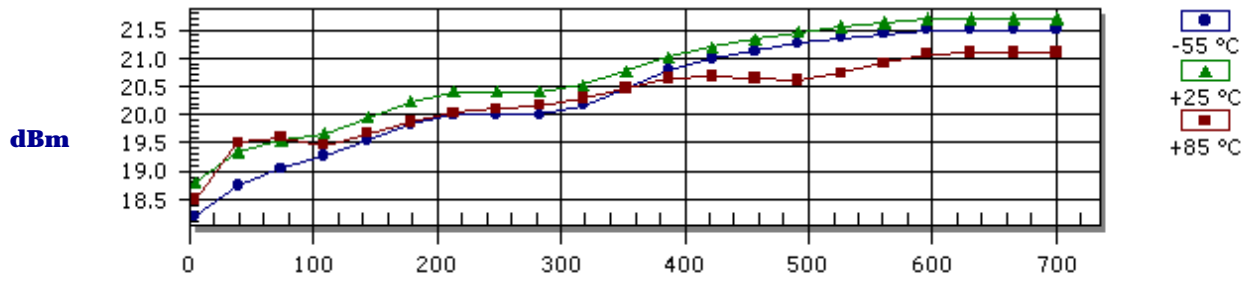

Frequency (MHz)

Reverse Isolation

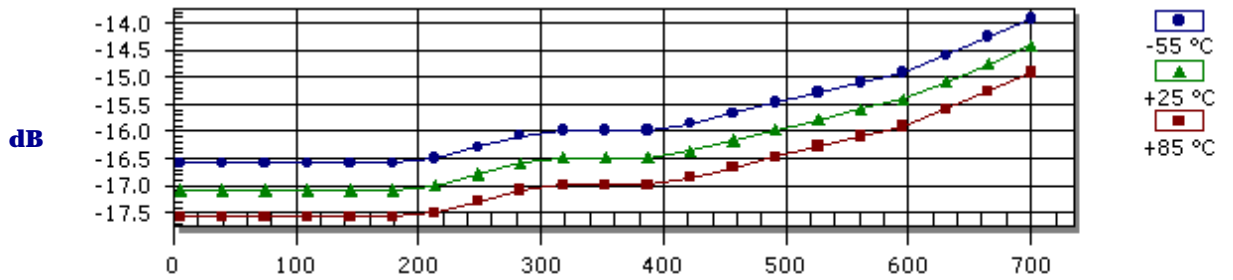

Frequency (MHz)

Input VSWR

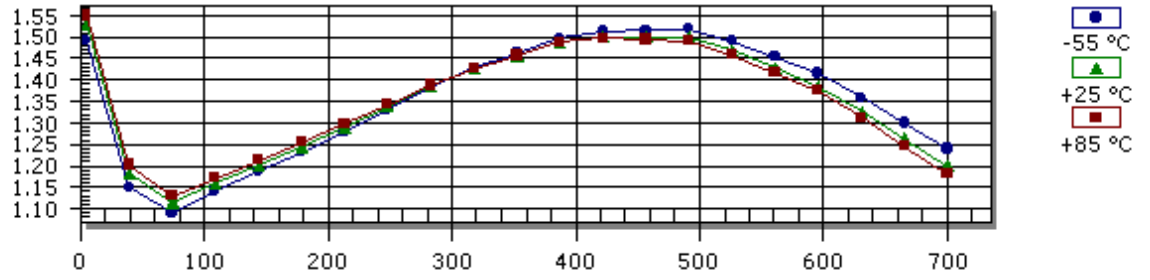

Frequency (MHz)

Output VSWR

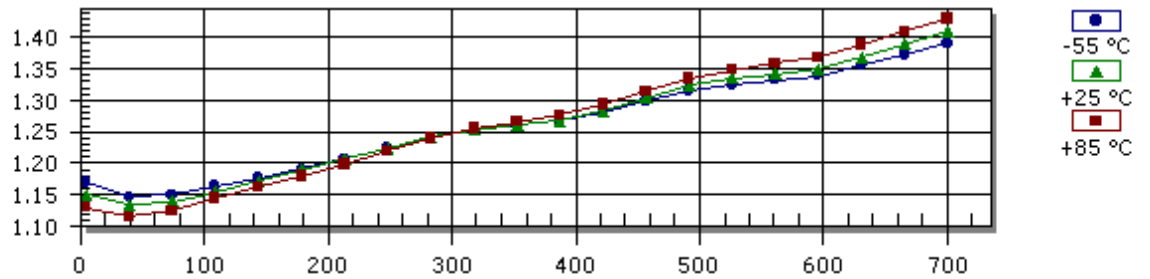

Frequency (MHz)

S-Parameters

Frequency	S11 Mag	S11 Ang	S21 Mag	S21 Ang	S12 Mag	S12 Ang	S22 Mag	S22 Ang
5.0	0.210	-65.00	3.930	-160.00	0.140	6.00	0.070	40.00
50.0	0.040	-2.00	4.070	168.00	0.140	-3.00	0.060	0.00
100.0	0.070	13.00	4.050	153.00	0.140	-7.00	0.070	8.00
200.0	0.120	-1.00	3.990	125.00	0.140	-15.00	0.090	-10.00
300.0	0.170	-25.00	3.970	97.00	0.150	-25.00	0.110	-40.00
400.0	0.200	-48.00	4.000	68.00	0.150	-35.00	0.120	-72.00
500.0	0.200	-71.00	4.050	39.00	0.160	-45.00	0.140	-114.00
600.0	0.160	-87.00	4.120	7.00	0.170	-58.00	0.150	-166.00
700.0	0.090	-57.00	4.010	-30.00	0.190	-73.00	0.170	130.00

Absolute Maximum Conditions

Maximum Operating Temperature	-55.0 - 100.0 °C	Maximum Storage Temperature	-62.0 - 125.0 °C
Maximum Case Temperature	125.0 °C	Maximum Supply Voltage	18.0 Volts
Continuous RF Input Power	18.0 dBm	Short Term RF Input Power (1 minute max)	50.0 mW
Maximum Peak Power (3 µsec max)	0.5 W		

Amplifonix | 2707 Black Lake Place | Philadelphia, PA 19154
Tel: 215.464.4000 | FAX: 215.464.4001 | Email: info@amplifonix.com

i2 Technologies US, Inc.

HTML Pages converted to PDF Document

This document contains component information from the manufacturer's website which are not available in a revision controlled document from the manufacturer. To facilitate the addition of these parts into the Electronics Database, we are converting the HTML pages related to that part, from the manufacturer's website into Adobe PDF format. The contents of this document is based on the information provided on the manufacturer's website, therefore the information may have been changed by the manufacturer since this was created.

