

Low-Saturation 1000mA Regulators

Monolithic IC MM170□□ Series

Outline

This IC is a small stabilized power supply IC that provides output voltage accuracy of $\pm 2\%$, output current of 1000mA (max.), and dropout voltage of 0.18V typ. with 1000mA. It also has an output noise reduction pin and output ON/OFF control pin (HSOP-8A). It is available in the TO-252A package in addition to HSOP-8A considering heat radiation.

Features

1. Current consumption (no load) 1mA typ.
2. High accuracy output voltage $\pm 2.0\%$
3. Dropout voltage 0.18V typ. ($I_o=1000\text{mA}$)
4. High ripple rejection 65dB typ.
5. Operating temperature range -40 to $+85^\circ\text{C}$
6. Output voltage 0.9 to 2.0V (0.1V steps)
7. Output capacitor $1\mu\text{F}$ (Ceramic)

Packages

1. HSOP-8A
2. TO-252A

Applications

1. TVs
2. Printers
3. DVD equipment
4. Portable equipment

Pin Assignment

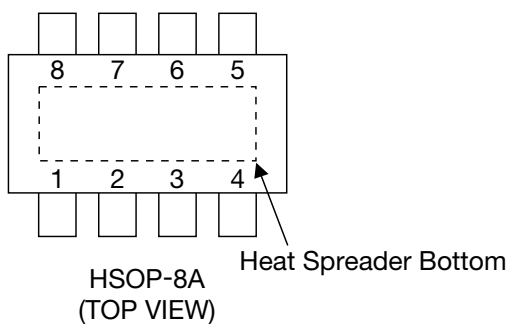

1	V_{OUT}
2	NC
3	GND
4	C_n
5	CONT
6	NC
7	NC
8	V_{IN}

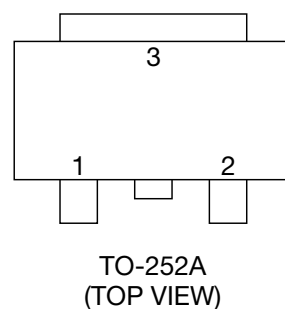

1	V_{IN}
2	V_o
3	GND

R No. table

■ Taping: B housing

Parts No.	Vo (V)	R No. (R59)
MM1700KHBE	0.9	7647
MM1701AHBE	1.0	7648
MM1701BHBE	1.1	7649
MM1701CHBE	1.2	7650
MM1701DHBE	1.3	7651
MM1701EHBE	1.4	7652
MM1701FHBE	1.5	7653
MM1701GHBE	1.6	7654
MM1701HHBE	1.7	7655
MM1701JHBE	1.8	7656
MM1701KHBE	1.9	7657
MM1702AHBE	2.0	7658

Block Diagram

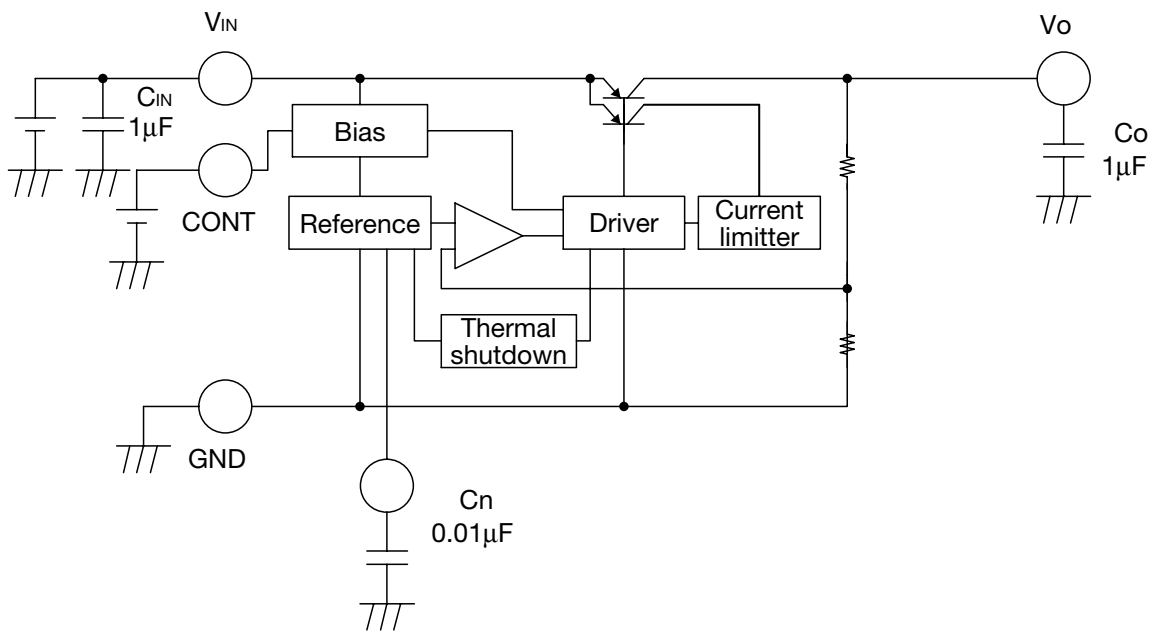

Pin Description (HSOP-8A)

Pin No.	Pin name	Function	Internal equivalent circuit diagram						
1	V _{OUT}	Output pin The capacitor must be connected with the output pin more than 1μF.							
2	NC	No connection							
3	GND	Ground							
4	Cn	Noise decrease pin Connecting with the 0.01μF capacitor can decrease output noise. If the capacitor is not connected, the pin may be influenced by outside noise.							
5	CONT	Control pin <table border="1"> <tr> <td>CONT</td> <td>Output</td> </tr> <tr> <td>H</td> <td>ON</td> </tr> <tr> <td>L</td> <td>OFF</td> </tr> </table>	CONT	Output	H	ON	L	OFF	
CONT	Output								
H	ON								
L	OFF								
6	NC	No connection							
7	NC	No connection							
8	V _{IN}	Input pin The capacitor is required to be connected with the input pin more than 1μF.							

Absolute Maximum Ratings (Ta=25°C)

Item	Symbol	Ratings	Units
Storage temperature	T _{STG}	-40~+150	°C
Supply voltage	V _{IN}	-0.3~+12	V
Power dissipation	P _d	1800 (*1)	mW

Note1: *1 With the double sided PC Board of glass epoxy. (37×37×1.6mm copper plane 80%)

Recommended Operating Conditions (Ta=25°C)

Item	Symbol	Ratings	Units
Operating temperature	T _{OPR}	-40~+85	°C
Output current	I _{OUT}	0~1	A
Operating voltage	V _{OP}	V _O (Typ.) +0.25~+10 (*1)	V

Note1: *1 The Operating voltage is (V_O+0.35V)~10V in the model less than V_{OUT}=1V.

Electrical Characteristics 1 (Except where noted otherwise, Ta=25°C, V_{IN}=V_O+0.5V, V_{CONT}=0.8V, I_O=1mA)

Item	Symbol	Measurement conditions	Min.	Typ.	Max.	Units
No-Load input current	I _{CC}	I _O =0mA		1	2	mA
Input current (OFF)	I _{CCOFF}	V _{CONT} =0V		0	1	μA
Output voltage *2	V _{OUT}		×0.98		×1.02	V
Dropout voltage *3	V _{IO}	V _{IN} =V _{OUT} -0.1V, I _O =1A		0.18	0.25	V
Line regulation	ΔV1	V _{IN} =V _O +0.5~V _O +1.5V		10	20	mV
Load regulation *1	ΔV2	I _O =0~1A		10	30	mV
V _{OUT} temperature coefficient *1	ΔV _{OUT} /ΔT	T _J =-40~+85°C		100		ppm/°C
Ripple rejection *1	RR	f=1kHz V _{ripple} =0.5V, I _O =250mA	50	65		dB
Output noise voltage *1	V _n	f _{BW} =20~80kHz C _n =0.01μF		60		μV _{rms}
		f _{BW} =20~80kHz C _n =OPEN		150		
CONT pin input current *4	I _{CONT}			0.3	0.6	μA
CONT pin high threshold level	V _{CONTH}		0.8		10	V
CONT pin low threshold level	V _{CONTL}		-0.3		0.2	V

Note 1: *1 The parameter is guaranteed by design.

Note 2: *2 Please refer to Electrical Characteristics 2.

Note 3: *3 The parameter is not guaranteed in the model less than V_{OUT}=1V.

Note 4: *4 Please refer to 'Characteristics'.

Electrical Characteristics 2 (Except where noted otherwise, Ta=25°C, V_{IN}=V_O+0.5V, I_O=1mA)

■ Output Voltage

Model No.	Test conditions	Output voltage		
		Min.	Typ.	Max.
MM1700K		0.870	0.9	0.930
MM1701A		0.970	1.0	1.030
MM1701B		1.070	1.1	1.130
MM1701C		1.170	1.2	1.230
MM1701D		1.270	1.3	1.330
MM1701E		1.370	1.4	1.430
MM1701F		1.470	1.5	1.530
MM1701G		1.568	1.6	1.632
MM1701H		1.666	1.7	1.734
MM1701J		1.764	1.8	1.836
MM1701K		1.862	1.9	1.938
MM1702A		1.960	2.0	2.040

Measuring Circuit (HSOP-8A)

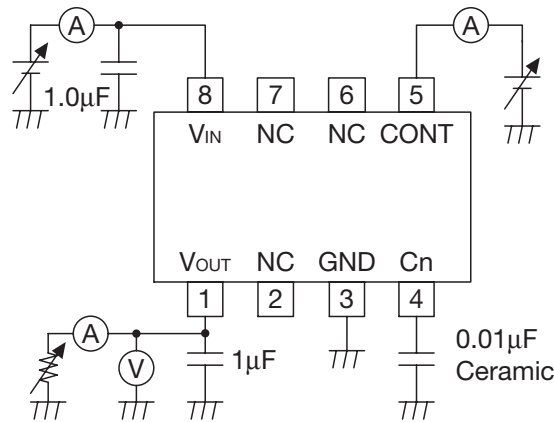

Application Circuit (HSOP-8A)

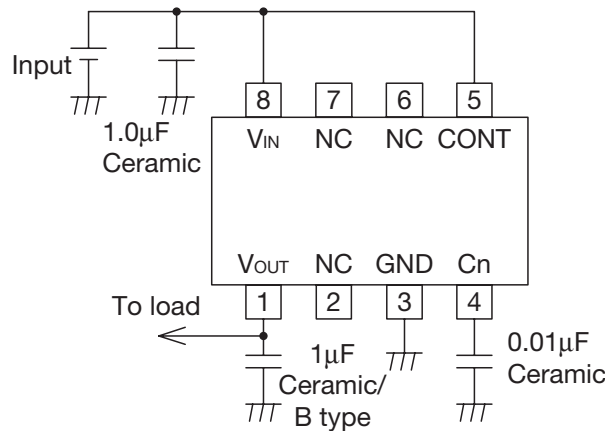

C _{IN}		C _{OUT}		Characteristics
Capacity	Kind	Capacity	Kind	
2.2µF or more	Ceramic	10µF	Ceramic	B type/X5R
1.0µF or more	Ceramic	1.0µF	Ceramic	B type/X5R

Note

1. The output capacitor is required between output and GND to prevent oscillation.
2. The output capacitor must be used in ESR stable area.
3. The wire of V_{CC} and GND is required to print full ground plane for noise and stability.
4. The input capacitor must be connected in 1cm from input pin.
5. The capacitor is connected to C_n must have low leakage current characteristics, because C_n pin is high impedance.
6. In case the output voltage is above the input voltage, the overcurrent flows by internal parasitic diode from output to input. In such application, the external bypass diode must be connected between the output pin and the input pin.

Power Dissipation

This IC's GND pin and the Heat Spreader Bottom effectively radiate heat. By increasing these copper foil pattern area of PCB, power dissipation improves. Please kindly design PCB pattern taking care of above features about the power dissipation.

Power Dissipation

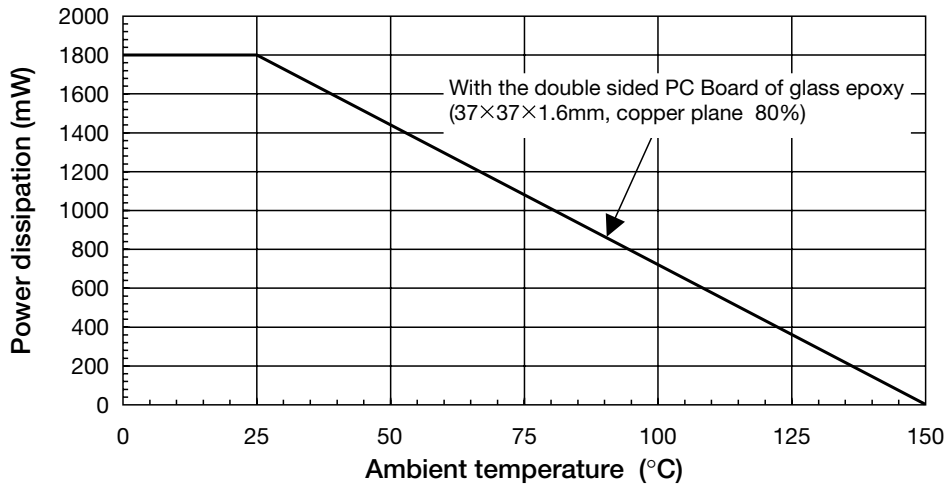

Land Pattern Recommendation

HSOP-8A

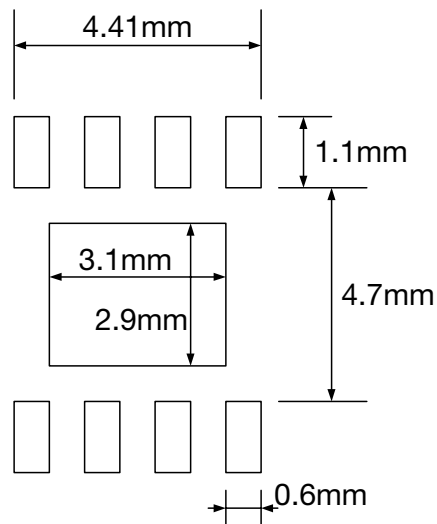

Note: These Dimensions are the reference values.

Characteristics ($V_o=1.2V$ Except where noted otherwise, $T_a=25^\circ C$, $V_{IN}=V_o+0.5V$, $V_{CONT}=0.8V$, $C_{IN}=1.0\mu F$, $C_o=1.0\mu F$)

Input Voltage-Output Voltage

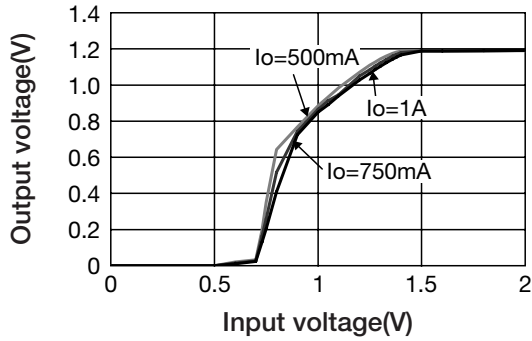

No Load Input Current

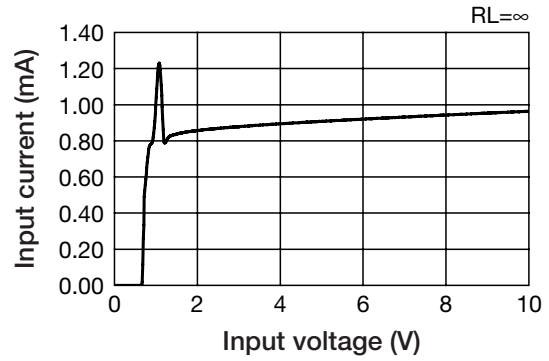

Load Regulation

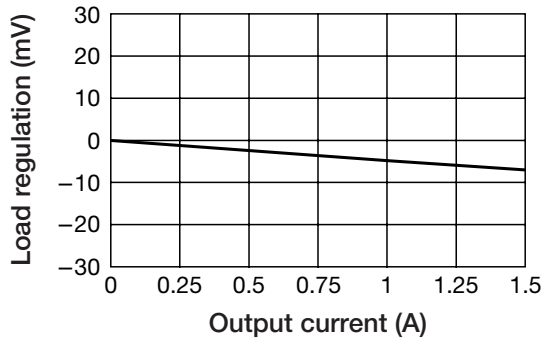

Line Regulation

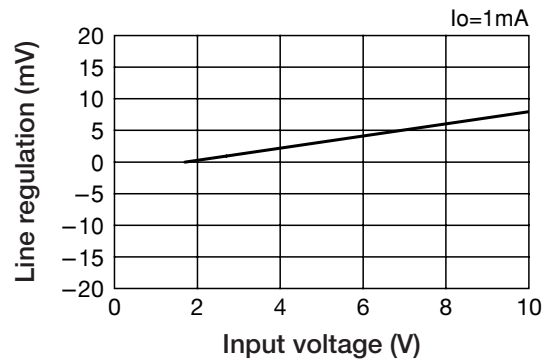

Drop Voltage

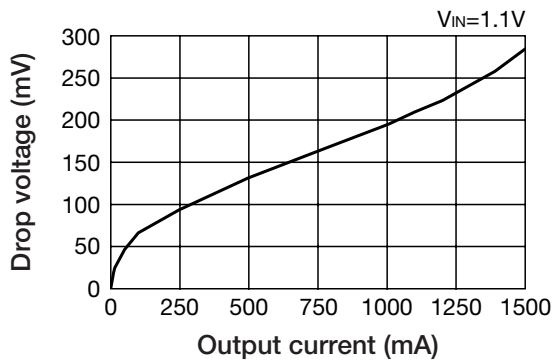

Output Voltage-Temperature

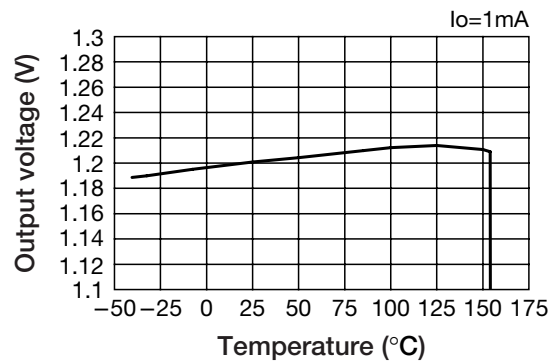

Characteristics ($V_o=1.2V$ Except where noted otherwise, $T_a=25^\circ C$, $V_{IN}=V_o+0.5V$, $V_{CONT}=0.8V$, $C_{IN}=1.0\mu F$, $C_o=1.0\mu F$)

Ripple Rejection

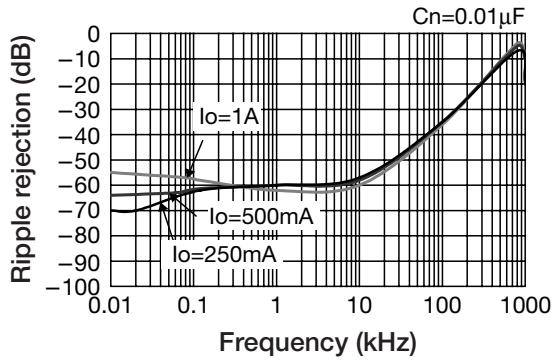

Current Limit

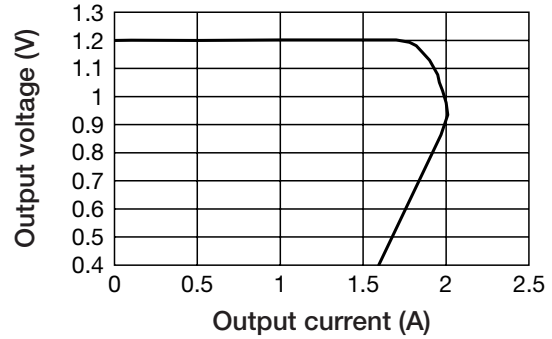

GND Pin Current

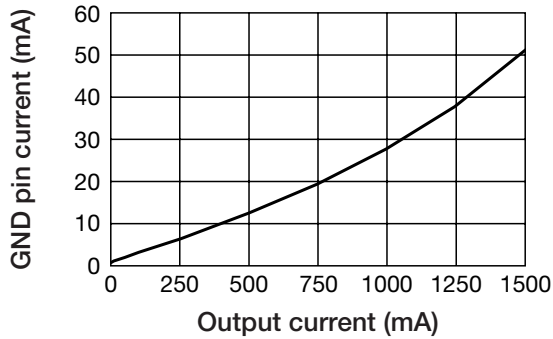

ESR Stable Area

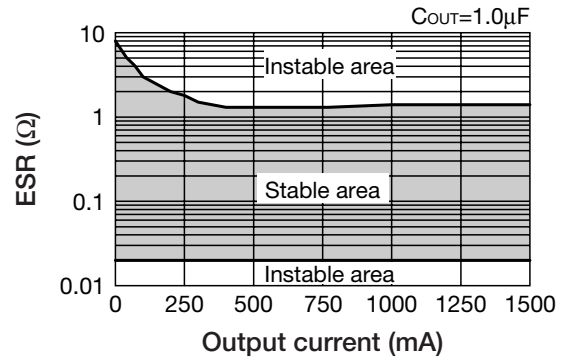

CONT Pin Input Current

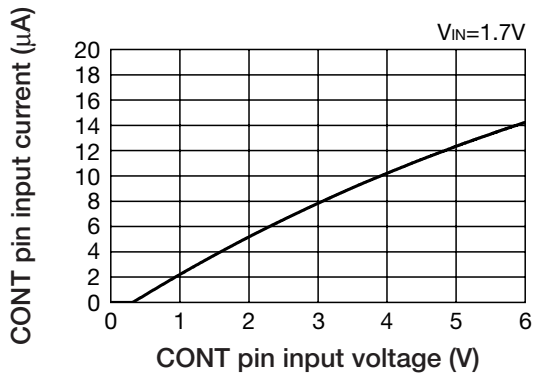

Characteristics ($V_o=0.9V$ Except where noted otherwise, $T_a=25^\circ C$, $V_{IN}=V_o+0.5V$, $V_{CONT}=0.8V$, $C_{IN}=1.0\mu F$, $C_o=1.0\mu F$)

Input Voltage-Output Voltage

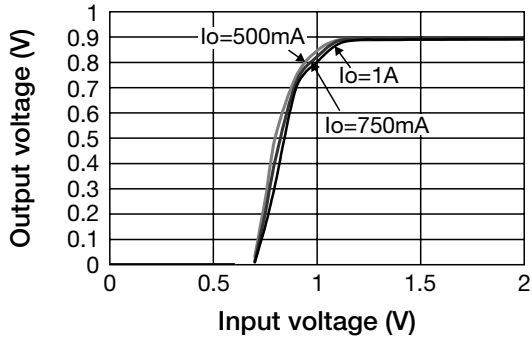

No Load Input Current

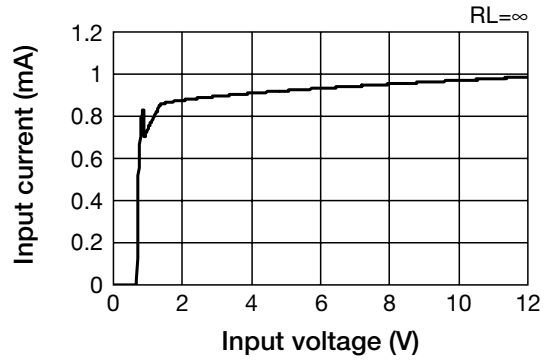

Load Regulation

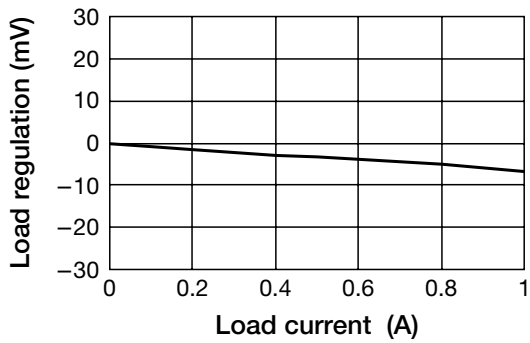

Line Regulation

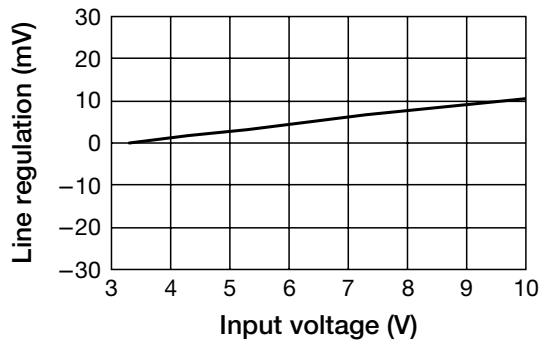

Drop Voltage

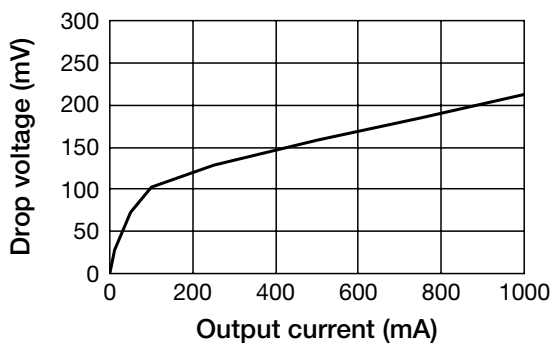

Temperature-Output Voltage

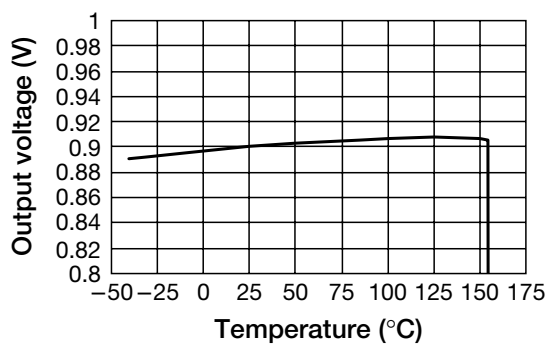

Characteristics ($V_o=1.8V$ Except where noted otherwise, $T_a=25^\circ C$, $V_{IN}=V_o+0.5V$, $V_{CONT}=0.8V$, $C_{IN}=1.0\mu F$, $C_o=1.0\mu F$)

Input Voltage-Output Voltage

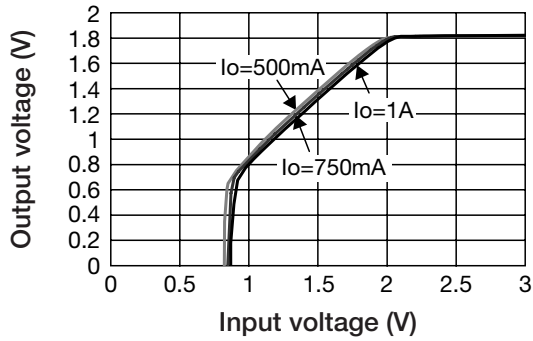

No Load Input Current

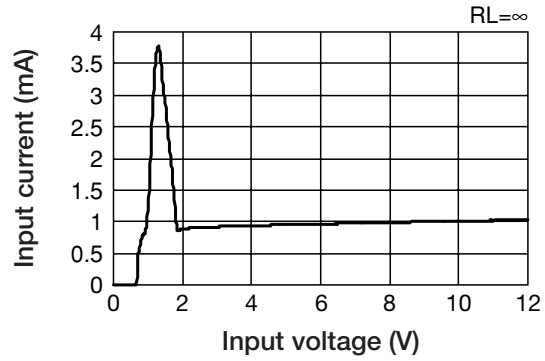

Load Regulation

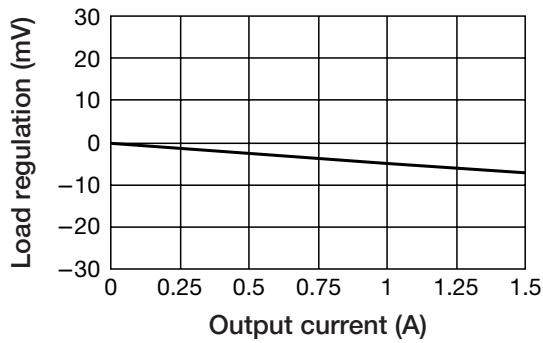

Line Regulation

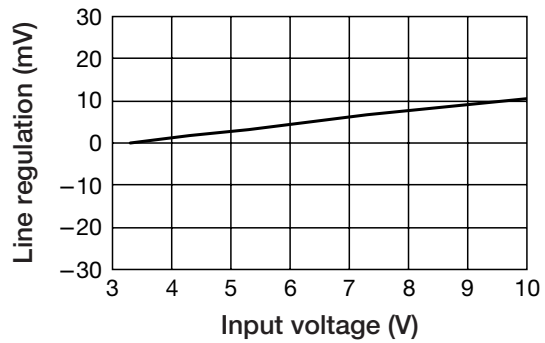

Drop Voltage

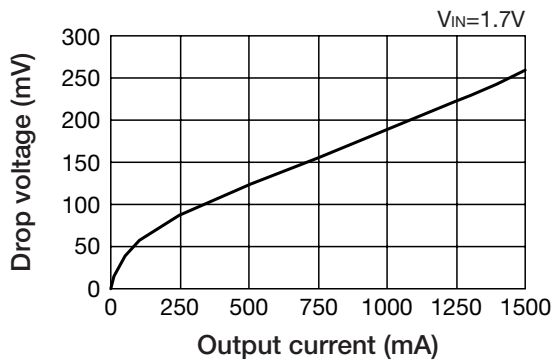

Temperature-Output Voltage

