

2K x 8 Reprogrammable Registered PROM

Features

- Windowed for reprogrammability
- CMOS for optimum speed/power
- High speed
 - 15-ns address set-up
 - 10-ns clock to output
- Low power
 - 330 mW (commercial) for -25 ns
 - 660 mW (military)
- Programmable synchronous or asynchronous output enable
- On-chip edge-triggered registers
- Programmable asynchronous register (INIT)
- EPROM technology, 100% programmable
- Slim, 300-mil, 24-pin plastic or hermetic DIP

- $5V \pm 10\% V_{CC}$, commercial and military
- TTL-compatible I/O
- Direct replacement for bipolar PROMs
- Capable of withstanding greater than 2001V static discharge

Functional Description

The CY7C245A is a high-performance, 2K x 8, electrically programmable, read only memory packaged in a slim 300-mil plastic or hermetic DIP. The ceramic package may be equipped with an erasure window; when exposed to UV light the PROM is erased and can then be reprogrammed. The memory cells utilize proven EPROM floating-gate technology and byte-wide intelligent programming algorithms.

The CY7C245A replaces bipolar devices and offers the advantages of lower power,

reprogrammability, superior performance and high programming yield. The EPROM cell requires only 12.5V for the supervoltage, and low current requirements allow gang programming. The EPROM cells allow each memory location to be tested 100%, because each location is written into, erased, and repeatedly exercised prior to encapsulation. Each PROM is also tested for AC performance to guarantee that after customer programming the product will meet AC specification limits.

The CY7C245A has an asynchronous initialize function (INIT). This function acts as a 2049th 8-bit word loaded into the on-chip register. It is user programmable with any desired word, or may be used as a PRESET or CLEAR function on the outputs. INIT is triggered by a low level, not an edge.

4

Logic Block Diagram

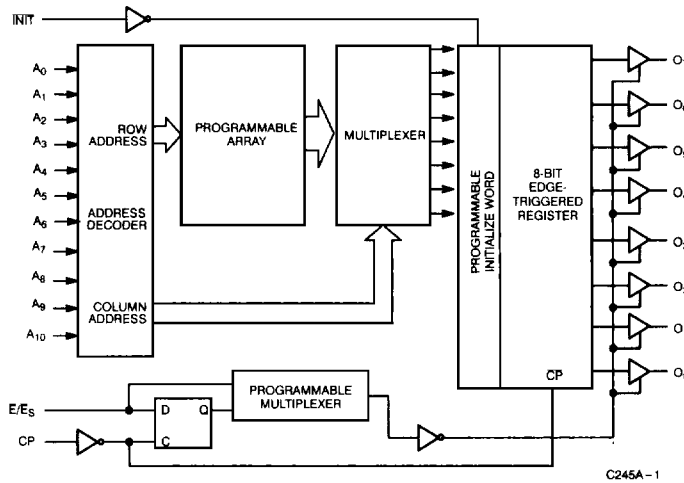

Pin Configurations

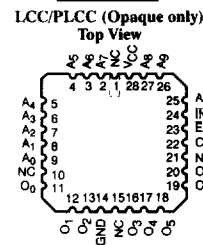
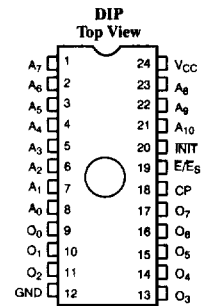

Selection Guide

		7C245A-15	7C245A-18	7C245A-25 7C245AL-25	7C245A-35 7C245AL-35	7C245A-45 7C245AL-45
Minimum Address Set-Up Time (ns)		15	18	25	35	45
Maximum Clock to Output (ns)		10	12	12	15	25
Maximum Operating Current (mA)	Standard	Commercial	120	120	90	90
		Military		120	120	120
	L	Commercial			60	60

Maximum Ratings

(Above which the useful life may be impaired. For user guidelines, not tested.)

Storage Temperature	-65°C to +150°C
Ambient Temperature with Power Applied	-55°C to +125°C
Supply Voltage to Ground Potential (Pin 24 to Pin 12)	-0.5V to +7.0V
DC Voltage Applied to Outputs in High Z State	-0.5V to +7.0V
DC Input Voltage	-3.0V to +7.0V
DC Program Voltage (Pins 7, 18, 20)	13.0V
UV Erasure	7258 Wsec/cm ²

Static Discharge Voltage (per MIL-STD-883, Method 3015)	> 2001V
Latch-Up Current	> 200 mA

Operating Range

Range	Ambient Temperature	V _{CC}
Commercial	0°C to +70°C	5V ±10%
Industrial ^[1]	-40°C to +85°C	5V ±10%
Military ^[2]	-55°C to +125°C	5V ±10%

Electrical Characteristics Over the Operating Range^[3, 4]

Parameter	Description	Test Conditions	7C245A-15		7C245A-18		7C245A-25 7C245A-35 7C245A-45		7C245AL-25 7C245AL-35 7C245AL-45		Unit	
			Min.	Max.	Min.	Max.	Min.	Max.	Min.	Max.		
V _{OH}	Output HIGH Voltage	V _{CC} = Min., I _{OH} = -4.0 mA V _{IN} = V _{IH} or V _{IL}	2.4		2.4		2.4		2.4		V	
V _{OL}	Output LOW Voltage	V _{CC} = Min., I _{OL} = 16 mA V _{IN} = V _{IH} or V _{IL}		0.4		0.4		0.4		0.4	V	
V _{IH}	Input HIGH Level	Guaranteed Input Logical HIGH Voltage for All Inputs	2.0	V _{CC}	2.0	V _{CC}	2.0	V _{CC}	2.0	V _{CC}	V	
V _{IL}	Input LOW Level	Guaranteed Input Logical LOW Voltage for All Inputs		0.8		0.8		0.8		0.8	V	
I _{Ix}	Input Leakage Current	GND ≤ V _{IN} ≤ V _{CC}	-10	+10	-10	+10	-10	+10	-10	+10	μA	
V _{CD}	Input Clamp Diode Voltage	Note 4										
I _{OZ}	Output Leakage Current	GND ≤ V _O ≤ V _{CC} Output Disabled ^[5]	-10	+10	-10	+10	-10	+10	-10	+10	μA	
I _{OS}	Output Short Circuit Current	V _{CC} = Max., V _{OUT} = 0.0V ^[6]	-20	-90	-20	-90	-20	-90	-20	-90	mA	
I _{CC}	Power Supply Current	V _{CC} = Max., I _{OUT} = 0 mA	Com'l		120		120		90		60	
			Mil		120		120					
V _{PP}	Programming Supply Voltage		12	13	12	13	12	13	12	13	V	
I _{PP}	Programming Supply Current			50		50		50		50	mA	
V _{IHP}	Input HIGH Programming Voltage		3.0		3.0		3.0		3.0		V	
V _{ILP}	Input LOW Programming Voltage			0.4		0.4		0.4		0.4	V	

Capacitance^[4]

Parameter	Description	Test Conditions	Max.	Unit
C _{IN}	Input Capacitance	T _A = 25°C, f = 1 MHz, V _{CC} = 5.0V	10	pF
C _{OUT}	Output Capacitance		10	pF

Notes:

- Contact a Cypress representative for industrial temperature range specifications.
- T_A is the "instant on" case temperature.
- See the last page of this specification for Group A subgroup testing information.
- See the "Introduction to CMOS PROMs" section of the Cypress Data Book for general information on testing.
- For devices using the synchronous enable, the device must be clocked after applying these voltages to perform this measurement.
- For test purposes, not more than one output at a time should be shorted. Short circuit test duration should not exceed 30 seconds.

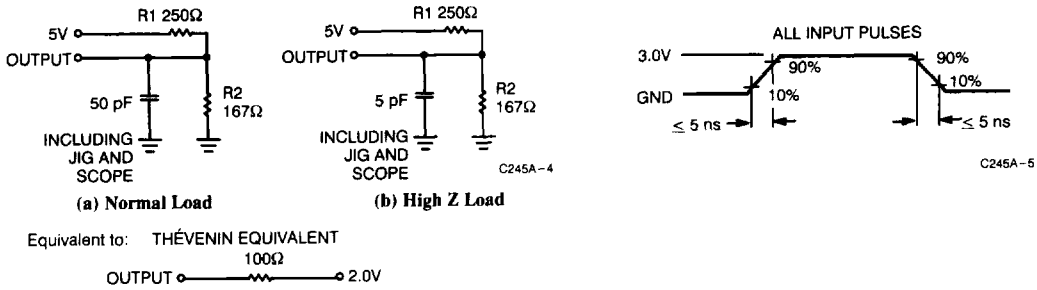
AC Test Loads and Waveforms^[3, 4]

Switching Characteristics Over Operating Range^[3, 4]

Parameter	Description	7C245A-15		7C245A-18		7C245A-25 7C245AL-25		7C245A-35 7C245AL-35		7C245A-45 7C245AL-45		Unit
		Min.	Max.	Min.	Max.	Min.	Max.	Min.	Max.	Min.	Max.	
t _{SA}	Address Set-Up to Clock HIGH	15		18		25		35		45		ns
t _{HA}	Address Hold from Clock HIGH	0		0		0		0		0		ns
t _{CO}	Clock HIGH to Valid Output		10		12		12		15		25	ns
t _{PWC}	Clock Pulse Width	10		12		15		20		20		ns
t _{SES}	\bar{E}_S Set-Up to Clock HIGH	10		10		12		15		15		ns
t _{HES}	\bar{E}_S Hold from Clock HIGH	5		5		5		5		5		ns
t _{DI}	Delay from INIT to Valid Output		15		20		20		20		35	ns
t _{RI}	INIT Recovery to Clock HIGH	10		12		15		20		20		ns
t _{PWI}	INIT Pulse Width	10		12		15		20		25		ns
t _{COS}	Valid Output from Clock HIGH ^[7]		15		15		15		20		30	ns
t _{HZC}	Inactive Output from Clock HIGH ^[7]		15		15		15		20		30	ns
t _{DOE}	Valid Output from \bar{E} LOW ^[8]		12		15		15		20		30	ns
t _{HZE}	Inactive Output from \bar{E} HIGH ^[8]		15		15		15		20		30	ns

Notes:

7. Applies only when the synchronous (\bar{E}_S) function is used.

8. Applies only when the asynchronous (\bar{E}) function is used.

Operating Modes

The CY7C245A is a CMOS electrically programmable read only memory organized as 2048 words x 8 bits and is a pin-for-pin replacement for bipolar TTL fusible link PROMs. The CY7C245A incorporates a D-type, master-slave register on chip, reducing the cost and size of pipelined microprogrammed systems and applications where accessed PROM data is stored temporarily in a register. Additional flexibility is provided with a programmable synchronous (\bar{E}_S) or asynchronous (\bar{E}) output enable and asynchronous initialization (INIT).

Upon power-up the state of the outputs will depend on the programmed state of the enable function (\bar{E}_S or \bar{E}). If the synchronous enable (\bar{E}_S) has been programmed, the register will be in the set condition causing the outputs ($O_0 - O_7$) to be in the OFF or high-impedance state. If the asynchronous enable (\bar{E}) is being used, the outputs will come up in the OFF or high-impedance state only if the enable (\bar{E}) input is at a HIGH logic level. Data is read by applying the memory location to the address inputs ($A_0 - A_{10}$) and a logic LOW to the enable input. The stored data is ac-

cessed and loaded into the master flip-flops of the data register during the address set-up time. At the next LOW-to-HIGH transition of the clock (CP), data is transferred to the slave flip-flops, which drive the output buffers, and the accessed data will appear at the outputs ($O_0 - O_7$).

If the asynchronous enable (\bar{E}) is being used, the outputs may be disabled at any time by switching the enable to a logic HIGH, and may be returned to the active state by switching the enable to a logic LOW.

If the synchronous enable (\bar{E}_S) is being used, the outputs will go to the OFF or high-impedance state upon the next positive clock edge after the synchronous enable input is switched to a HIGH level. If the synchronous enable pin is switched to a logic LOW, the subsequent positive clock edge will return the output to the active state. Following a positive clock edge, the address and synchronous enable inputs are free to change since no change in the output will occur until the next LOW-to-HIGH transition of the clock. This unique feature allows the CY7C245A decoders and

Operating Modes (continued)

sense amplifiers to access the next location while previously addressed data remains stable on the outputs.

System timing is simplified in that the on-chip edge triggered register allows the PROM clock to be derived directly from the system clock without introducing race conditions. The on-chip register timing requirements are similar to those of discrete registers available in the market.

The CY7C245A has an asynchronous initialize input ($\overline{\text{INIT}}$). The initialize function is useful during power-up and time-out sequences and can facilitate implementation of other sophisticated functions such as a built-in "jump start" address. When activated, the initialize control input causes the contents of a user-pro-

grammed 2049th 8-bit word to be loaded into the on-chip register. Each bit is programmable and the initialize function can be used to load any desired combination of 1s and 0s into the register. In the unprogrammed state, activating $\overline{\text{INIT}}$ will generate a register CLEAR (all outputs LOW). If all the bits of the initialize word are programmed, activating $\overline{\text{INIT}}$ performs a register PRESET (all outputs HIGH).

Applying a LOW to the $\overline{\text{INIT}}$ input causes an immediate load of the programmed initialize word into the master and slave flip-flops of the register, independent of all other inputs, including the clock (CP). The initialize data will appear at the device outputs after the outputs are enabled by bringing the asynchronous enable (E) LOW.

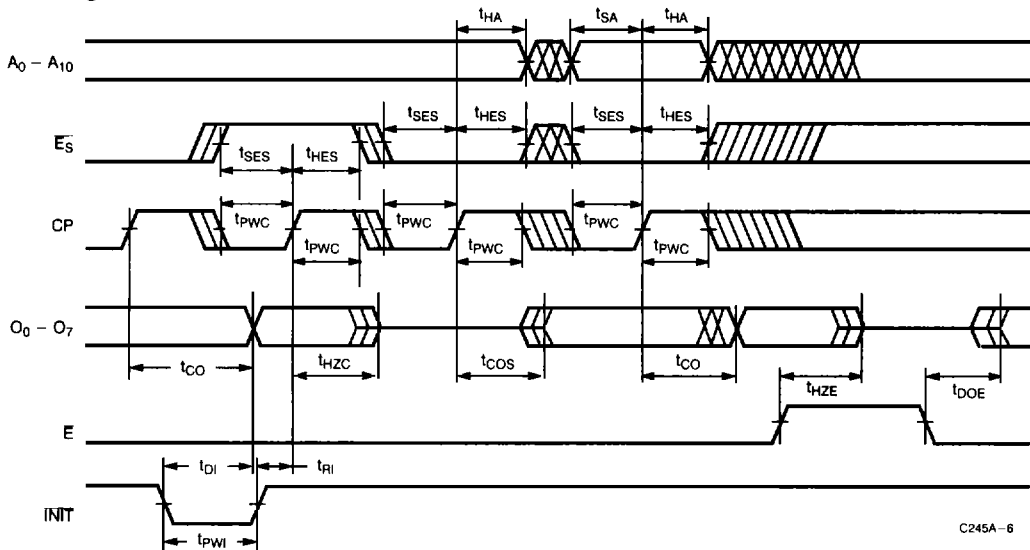
Switching Waveforms⁽⁴⁾

C245A-6

Erase Characteristics

Wavelengths of light less than 4000 Å begin to erase the 7C245A. For this reason, an opaque label should be placed over the window if the PROM is exposed to sunlight or fluorescent lighting for extended periods of time.

The recommended dose for erasure is ultraviolet light with a wavelength of 2537 Å for a minimum dose (UV intensity multiplied by exposure time) of 25 Wsec/cm². For an ultraviolet lamp with a 12 mW/cm² power rating the exposure time would be approximately 35 minutes. The 7C245A needs to be within 1 inch of the lamp during erasure. Permanent damage may result if the PROM is exposed to high-intensity UV light for an extended period of time. 7258 Wsec/cm² is the recommended maximum dosage.

Programming Information

Programming support is available from Cypress as well as from a number of third-party software vendors. For detailed programming information, including a listing of software packages, please see the PROM Programming Information located at the end of

this section. Programming algorithms can be obtained from any Cypress representative.

Bit Map Data

Programmer Address		RAM Data
Decimal	Hex	Contents
0	0	Data
.	.	.
.	.	.
.	.	.
2047	7FF	Data
2048	800	Init Byte
2049	801	Control Byte

Control Byte

- (0) Asynchronous output enable (default state)
- (1) Synchronous output enable

Table 1. Mode Selection

Mode	Pin Function ^[9]									
	Read or Output Disable	A ₁₀ - A ₄	A ₃	A ₂ - A ₁	A ₀	CP	\bar{E} , \bar{E}_S	INIT	O ₇ - O ₀	
	Other	A ₁₀ - A ₄	A ₃	A ₂ - A ₁	A ₀	PGM	VFY	V _{PP}	D ₇ - D ₀	
Read		A ₁₀ - A ₄	A ₃	A ₂ - A ₁	A ₀	V _{IL} /V _{IH}	V _{IL}	V _{IH}	O ₇ - O ₀	
Output Disable		A ₁₀ - A ₄	A ₃	A ₂ - A ₁	A ₀	X	V _{IH}	V _{IH}	High Z	
Initialize		A ₁₀ - A ₄	A ₃	A ₂ - A ₁	A ₀	X	V _{IL}	V _{IL}	Init. Byte	
Program		A ₁₀ - A ₄	A ₃	A ₂ - A ₁	A ₀	V _{ILP}	V _{IHP}	V _{PP}	D ₇ - D ₀	
Program Verify		A ₁₀ - A ₄	A ₃	A ₂ - A ₁	A ₀	V _{IHP}	V _{ILP}	V _{PP}	O ₇ - O ₀	
Program Inhibit		A ₁₀ - A ₄	A ₃	A ₂ - A ₁	A ₀	V _{IHP}	V _{IHP}	V _{PP}	High Z	
Intelligent Program		A ₁₀ - A ₄	A ₃	A ₂ - A ₁	A ₀	V _{ILP}	V _{IHP}	V _{PP}	D ₇ - D ₀	
Program Synchronous Enable		A ₁₀ - A ₄	V _{IHP}	A ₂ - A ₁	V _{PP}	V _{ILP}	V _{IHP}	V _{PP}	High Z	
Program Initialization Byte		A ₁₀ - A ₄	V _{ILP}	A ₂ - A ₁	V _{PP}	V _{ILP}	V _{IHP}	V _{PP}	D ₇ - D ₀	
Blank Check Zeros		A ₁₀ - A ₄	A ₃	A ₂ - A ₁	A ₀	V _{IHP}	V _{ILP}	V _{PP}	Zeros	

Note:

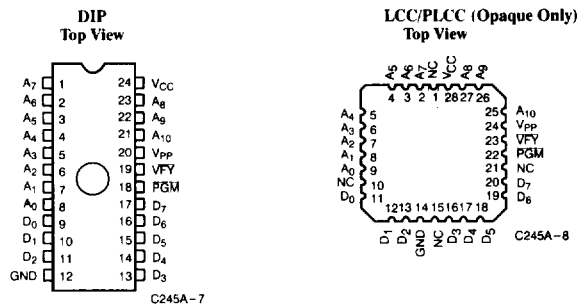
 9. X = "don't care" but not to exceed V_{CC} + 5%.

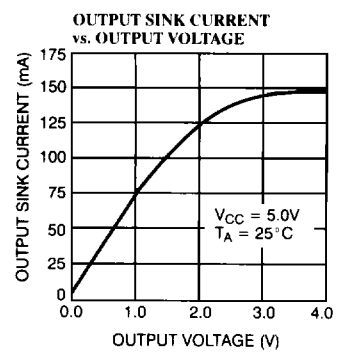
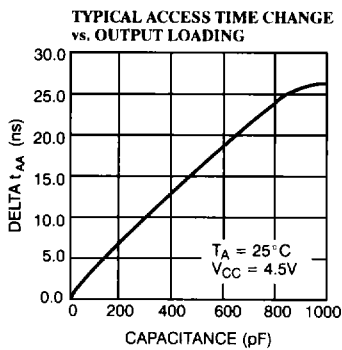
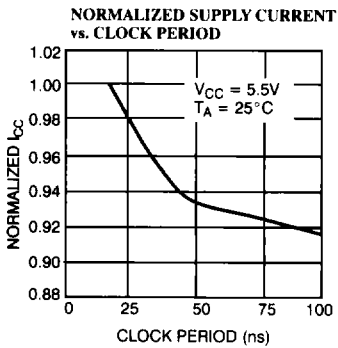
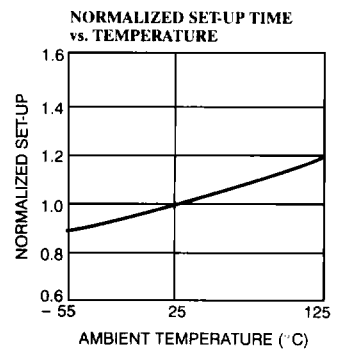
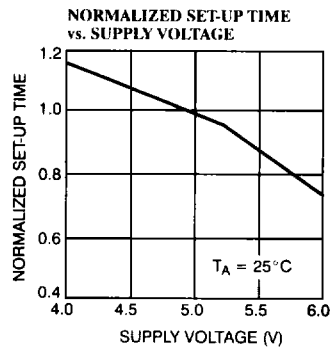
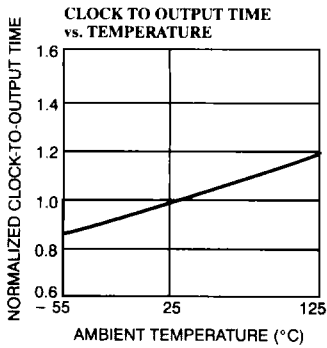
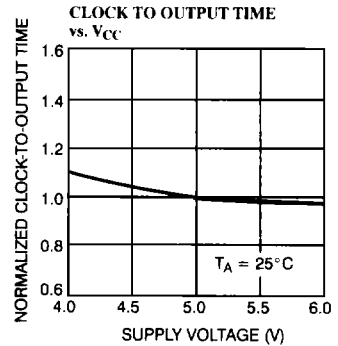
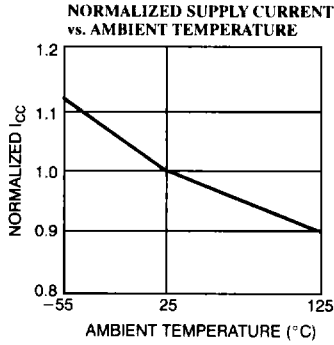
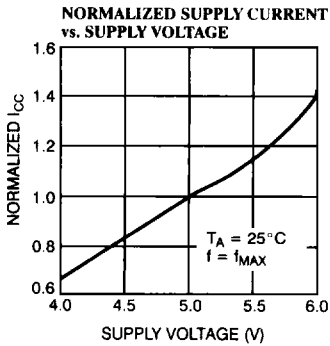
Figure 1. Programming Pinouts

Typical DC and AC Characteristics

Ordering Information^[10]

Speed (ns)		I _{CC} (mA)	Ordering Code	Package Type	Package Type	Operating Range
t _{SA}	t _{CO}					
15	10	120	CY7C245A-15JC	J64	28-Lead Plastic Leaded Chip Carrier	Commercial
			CY7C245A-15PC	P13	24-Lead (300-Mil) Molded DIP	
			CY7C245A-15WC	W14	24-Lead (300-Mil) Windowed CerDIP	
18	12	120	CY7C245A-18JC	J64	28-Lead Plastic Leaded Chip Carrier	Commercial
			CY7C245A-18PC	P13	24-Lead (300-Mil) Molded DIP	
			CY7C245A-18WC	W14	24-Lead (300-Mil) Windowed CerDIP	
		CY7C245A-18DMB	D14	24-Lead (300-Mil) CerDIP	Military	
		CY7C245A-18LMB	L64	28-Square Leadless Chip Carrier		
		CY7C245A-18QMB	Q64	28-Pin Windowed Leadless Chip Carrier		
		CY7C245A-18TMB	T73	24-Lead Windowed Cerpack		
CY7C245A-18WMB	W14	24-Lead (300-Mil) Windowed CerDIP				
25	15	60	CY7C245AL-25PC	P13	24-Lead (300-Mil) Molded DIP	Commercial
			CY7C245AL-25WC	W14	24-Lead (300-Mil) Windowed CerDIP	
			CY7C245A-25JC	J64	28-Lead Plastic Leaded Chip Carrier	
		CY7C245A-25PC	P13	24-Lead (300-Mil) Molded DIP	Military	
		CY7C245A-25SC	S13	24-Lead Molded SOIC		
		CY7C245A-25WC	W14	24-Lead (300-Mil) Windowed CerDIP		
		CY7C245A-25DMB	D14	24-Lead (300-Mil) CerDIP		
		CY7C245A-25LMB	L64	28-Square Leadless Chip Carrier		
		CY7C245A-25QMB	Q64	28-Pin Windowed Leadless Chip Carrier		
		CY7C245A-25TMB	T73	24-Lead Windowed Cerpack		
		CY7C245A-25WMB	W14	24-Lead (300-Mil) Windowed CerDIP		
35	20	60	CY7C245AL-35PC	P13	24-Lead (300-Mil) Molded DIP	Commercial
			CY7C245AL-35WC	W14	24-Lead (300-Mil) Windowed CerDIP	
			CY7C245A-35JC	J64	28-Lead Plastic Leaded Chip Carrier	
		CY7C245A-35PC	P13	24-Lead (300-Mil) Molded DIP	Military	
		CY7C245A-35SC	S13	24-Lead Molded SOIC		
		CY7C245A-35WC	W14	24-Lead (300-Mil) Windowed CerDIP		
		CY7C245A-35DMB	D14	24-Lead (300-Mil) CerDIP		
		CY7C245A-35LMB	L64	28-Square Leadless Chip Carrier		
		CY7C245A-35QMB	Q64	28-Pin Windowed Leadless Chip Carrier		
		CY7C245A-35TMB	T73	24-Lead Windowed Cerpack		
		CY7C245A-35WMB	W14	24-Lead (300-Mil) Windowed CerDIP		
45	25	60	CY7C245A-45JC	J64	28-Lead Plastic Leaded Chip Carrier	Commercial
			CY7C245A-45PC	P13	24-Lead (300-Mil) Molded DIP	
			CY7C245A-45JC	J64	28-Lead Plastic Leaded Chip Carrier	
		CY7C245A-45PC	P13	24-Lead (300-Mil) Molded DIP	Military	
		CY7C245A-45SC	S13	24-Lead Molded SOIC		
		CY7C245A-45WC	W14	24-Lead (300-Mil) Windowed CerDIP		
		CY7C245A-45DMB	D14	24-Lead (300-Mil) CerDIP		
		CY7C245A-45LMB	L64	28-Square Leadless Chip Carrier		
		CY7C245A-45QMB	Q64	28-Pin Windowed Leadless Chip Carrier		
		CY7C245A-45TMB	T73	24-Lead Windowed Cerpack		
		CY7C245A-45WMB	W14	24-Lead (300-Mil) Windowed CerDIP		

Note:

10. Most of these products are available in industrial temperature range. Contact a Cypress representative for specifications and product availability.



MILITARY SPECIFICATIONS
Group A Subgroup Testing

DC Characteristics

Parameter	Subgroups
V _{OH}	1, 2, 3
V _{OL}	1, 2, 3
V _{IH}	1, 2, 3
V _{IL}	1, 2, 3
I _{Ix}	1, 2, 3
I _{OZ}	1, 2, 3
I _{CC}	1, 2, 3

Switching Characteristics

Parameter	Subgroups
t _{SA}	7, 8, 9, 10, 11
t _{HA}	7, 8, 9, 10, 11
t _{CO}	7, 8, 9, 10, 11

SMD Cross Reference

SMD Number	Suffix	Cypress Number
5962-88735	01KX	CY7C245A-45KMB
5962-88735	01LX	CY7C245A-45DMB
5962-88735	013X	CY7C245A-45LMB
5962-88735	02KX	CY7C245A-35KMB
5962-88735	02LX	CY7C245A-35DMB
5962-88735	023X	CY7C245A-35LMB
5962-88735	03KX	CY7C245A-35KMB
5962-88735	03LX	CY7C245A-35DMB
5962-88735	033X	CY7C245A-25LMB
5962-88735	04KX	CY7C245A-25KMB
5962-88735	04LX	CY7C245A-25DMB
5962-88735	043X	CY7C245A-25LMB
5962-87529	01KX	CY7C245A-45TMB
5962-87529	01LX	CY7C245A-45WMB
5962-87529	013X	CY7C245A-45QMB
5962-87529	02KX	CY7C245A-35TMB
5962-87529	02LX	CY7C245A-35WMB
5962-87529	023X	CY7C245A-35QMB
5962-89815	01LX	CY7C245A-35WMB
5962-89815	01KX	CY7C245A-35TMB
5962-89815	013X	CY7C245A-35QMB
5962-89815	02LX	CY7C245A-25WMB
5962-89815	02KX	CY7C245A-25TMB
5962-89815	023X	CY7C245A-25QMB
5962-89815	03LX	CY7C245A-18WMB
5962-89815	03KX	CY7C245A-18TMB
5962-89815	033X	CY7C245A-18QMB

Document #: 38-00074-G