

50 ohm balun transformer for 2G45 ISM matched Nordic Semiconductor chips with ultralow power transceivers

Datasheet – production data

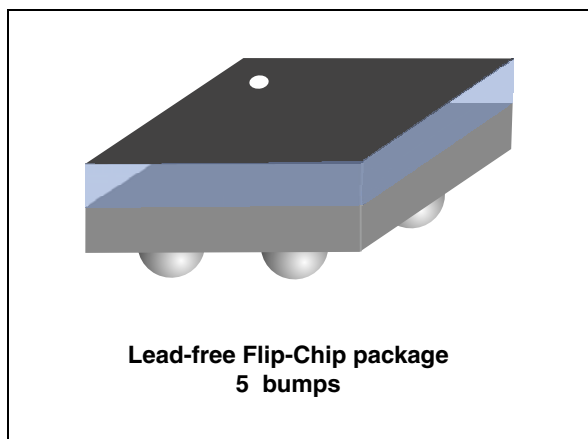
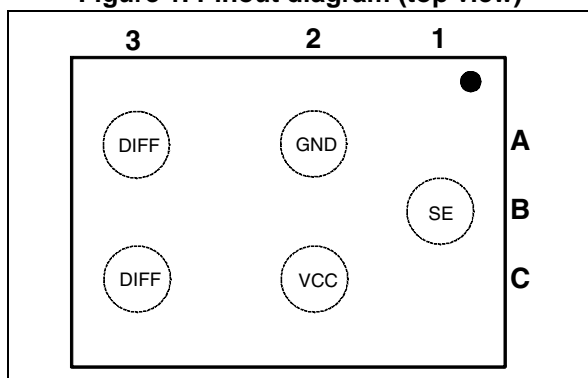

Figure 1. Pinout diagram (top view)



Features

- 50 Ω nominal input / conjugate match to Nordic Semiconductor chips nRF24LE1 QFN32, nRF24AP2-1CH, nRF24AP2-8CH, nRF51422 and nRF51822
- Low insertion loss
- Low amplitude imbalance
- Low phase imbalance
- Small footprint: < 1.5 mm²

Benefits

- Very low profile: < 595 μ m after reflow
- High RF performance
- RF BOM and area reduction

Applications

- 2.45 GHz impedance matched balun filter
- Optimized for Nordic's chip set nRF24LE1/AP2 and nRF51 series

Description

STMicroelectronics BAL-NRF01D3 is an ultraminiature balun. The BAL-NRF01D3 integrates matching network and harmonics filter. Matching impedance has been customized for the following Nordic Semiconductor circuits: nRF24LE1 QFN-32 pins, nRF24AP2-1CH, nRF24AP2-8CH, nRF51422 and nRF51822.

The BAL-NRF01D3 uses STMicroelectronics IPD technology on non-conductive glass substrate which optimize RF performances.

The BAL-NRF01D3 has been tested and approved by Nordic Semiconductor in their nRF2723 and nRF2752 nRFgo modules.

1 Characteristics

Table 1. Absolute maximum ratings (limiting values)

Symbol	Parameter	Value			Unit
		Min.	Typ.	Max.	
P _{IN}	Input Power RFIN			20	dBm
V _{ESD}	ESD ratings MIL STD883C (HBM: C = 100 pF, R = 1.5 kΩ, air discharge)	2000			V
	ESD ratings charge device model (JESD22-C101-C)	500			
	ESD ratings machine model (MM: C = 200 pF, R = 25 Ω, L = 500 nH)	200			
T _{OP}	Operating temperature	-40		+85	°C

Table 2. Impedances (T_{amb} = 25 °C)

Symbol	Parameter	Value			Unit
		Min.	Typ.	Max.	
Z _{OUT}	Nominal differential output impedance		conjugate match to nRF24LE1/AP2, nRF51422, nRF51822		Ω
Z _{IN}	Nominal input impedance		50		Ω

Table 3. RF performance (T_{amb} = 25 °C)

Symbol	Parameter	Test condition	Value			Unit
			Min.	Typ.	Max.	
F	Frequency range (bandwidth)		2400		2540	MHz
I _L	Insertion loss in bandwidth			2.25		dB
R _L	Return loss in bandwidth			10		dB
φ _{imb}	Phase imbalance			3		°
A _{imb}	Amplitude imbalance			0.1		dB
2f ₀	2nd harmonic filtering	4880 MHz		10		dB
3f ₀	3rd harmonic filtering	7320 MHz		20		dB

1.1 On-board simulations

Figure 2. Transmission ($T_{amb} = 25\text{ }^{\circ}\text{C}$)

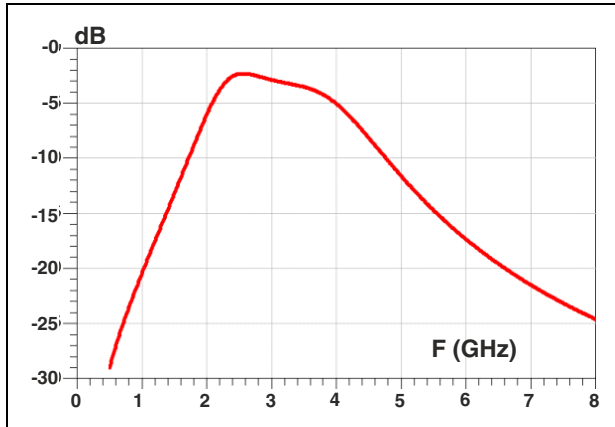

Figure 3. Return loss on SE port ($T_{amb} = 25\text{ }^{\circ}\text{C}$)

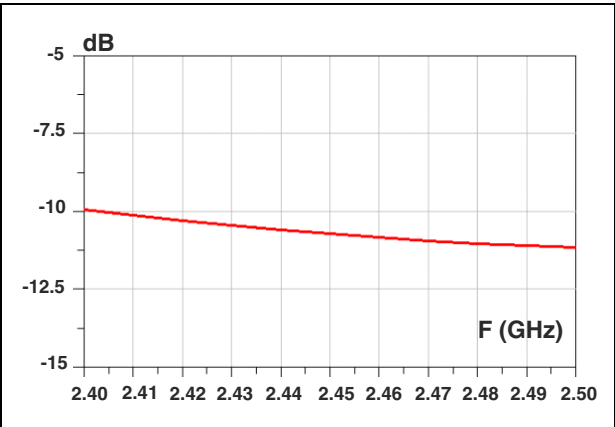

Figure 4. Return loss on DIFF port ($T_{amb} = 25\text{ }^{\circ}\text{C}$)

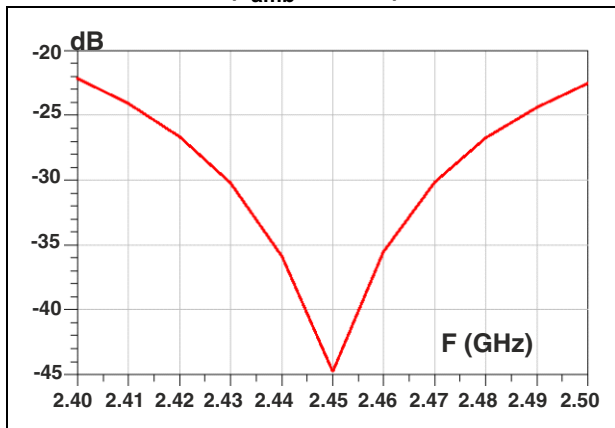

Figure 5. Amplitude imbalance ($T_{amb} = 25\text{ }^{\circ}\text{C}$)

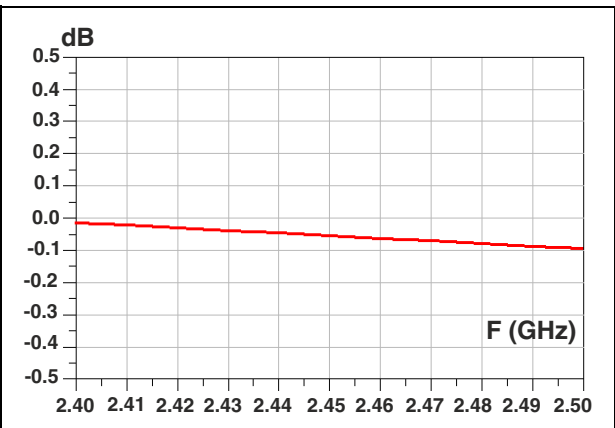
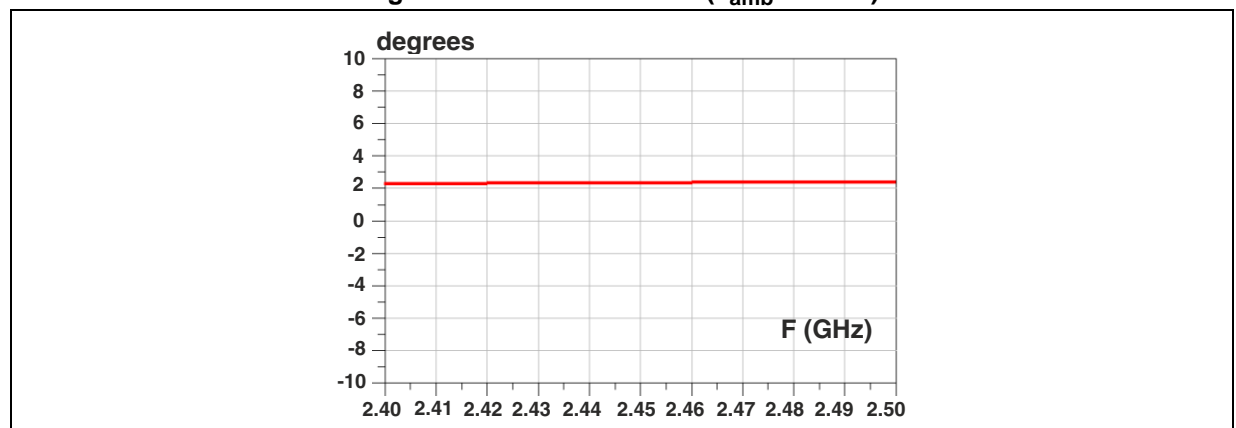

Figure 6. Phase imbalance ($T_{amb} = 25\text{ }^{\circ}\text{C}$)



2 Application information

Figure 7. Application schematic (courtesy of Nordic Semiconductor)

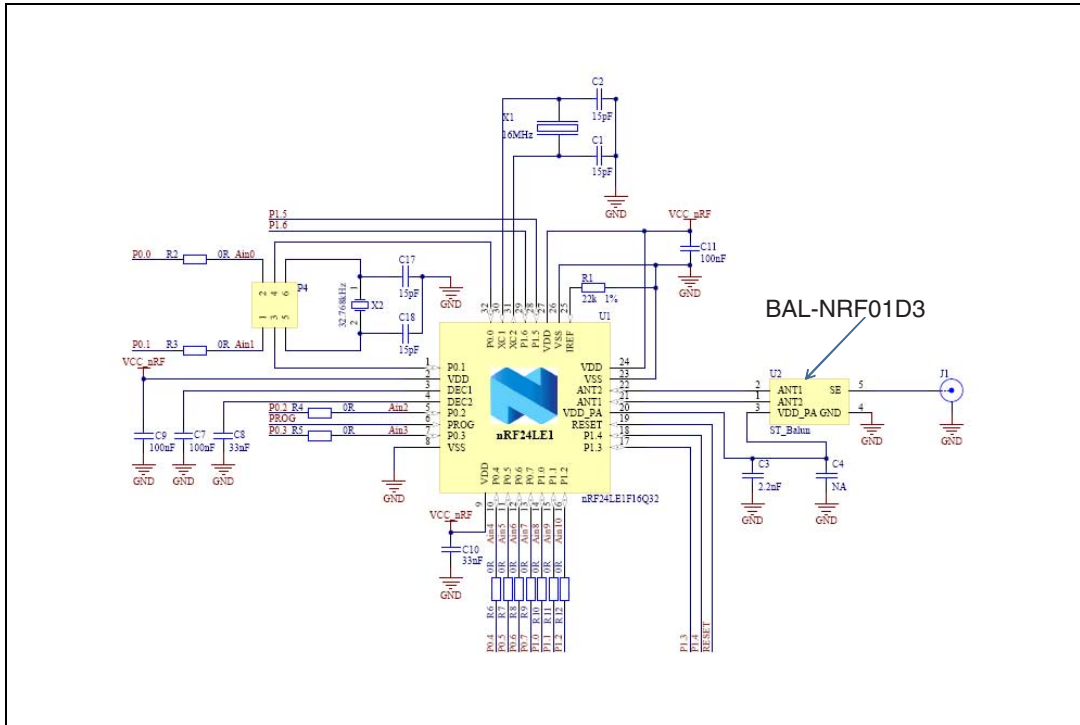

Figure 8. nRF2723 application board (courtesy of Nordic Semiconductor)

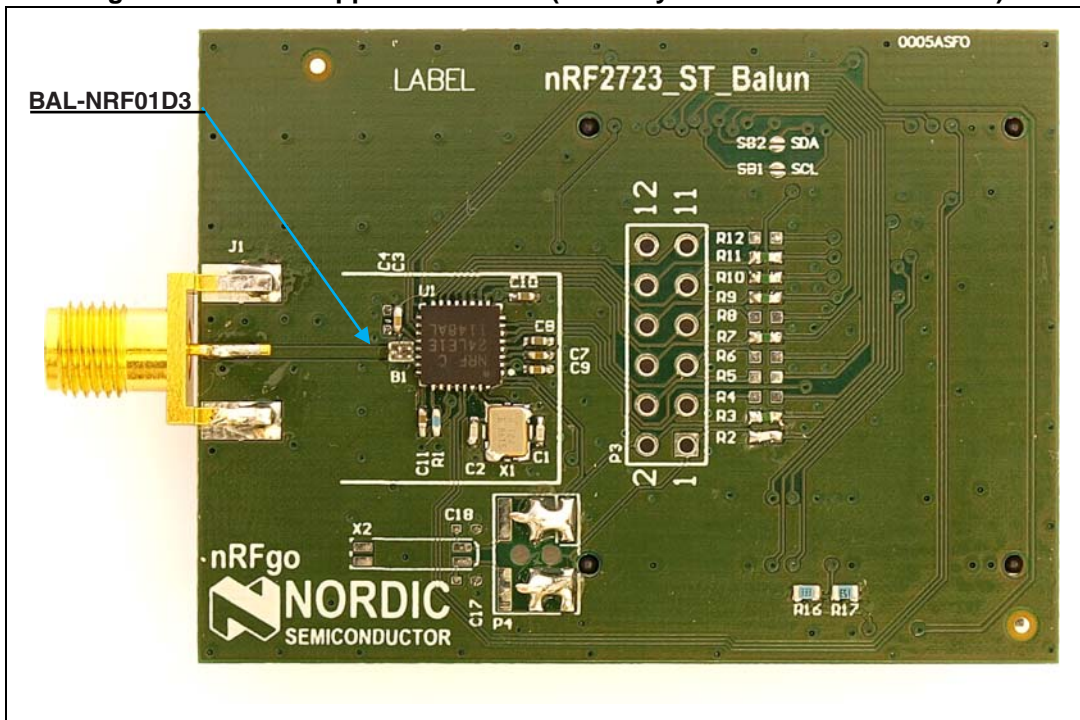

Figure 9. nRF2752 application board (courtesy of Nordic Semiconductor)



3 Package information

- Epoxy meets UL94, V0
- Lead-free package

In order to meet environmental requirements, ST offers these devices in different grades of ECOPACK® packages, depending on their level of environmental compliance. ECOPACK® specifications, grade definitions and product status are available at: www.st.com. ECOPACK® is an ST trademark.

Figure 10. Package dimensions (top and side view)

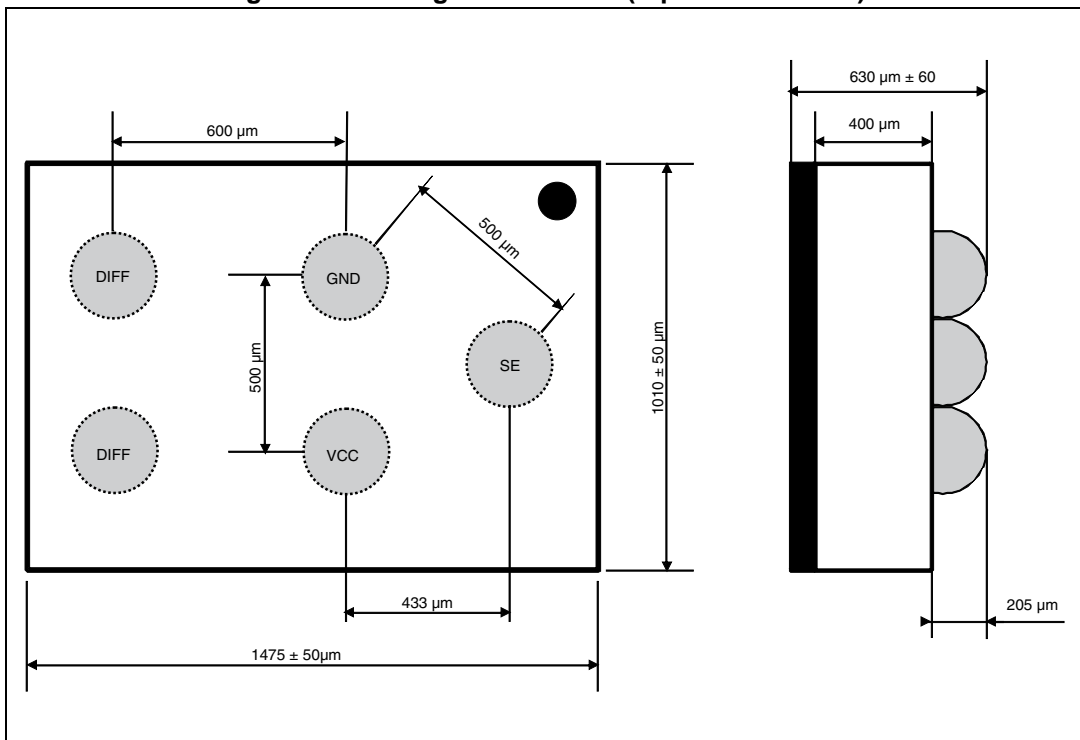

Figure 11. Footprint - non solder mask defined

Figure 12. Footprint - solder mask defined

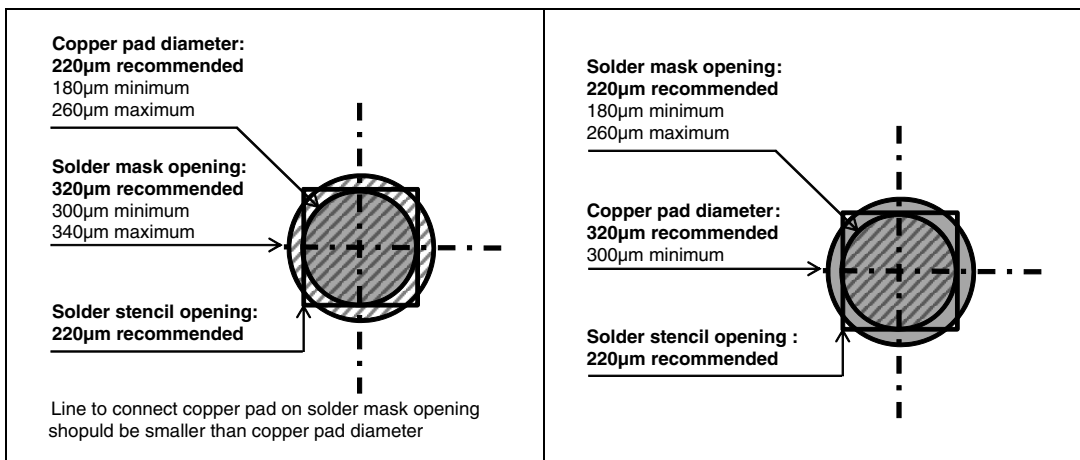

Figure 13. Marking

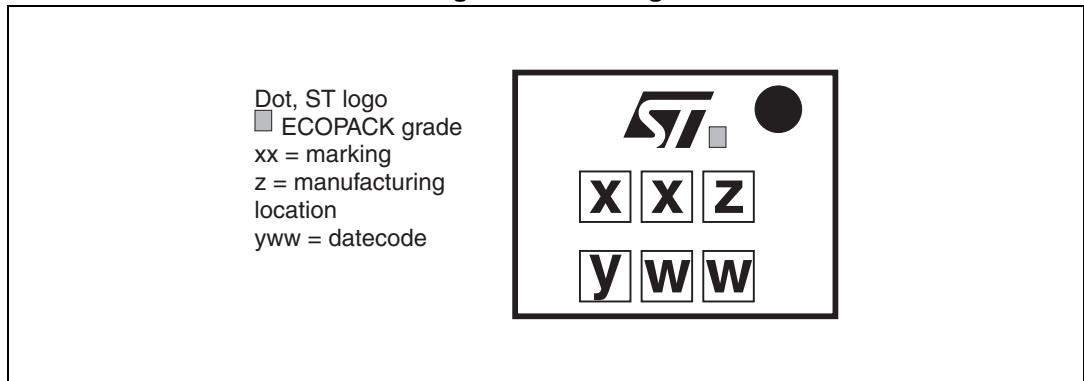
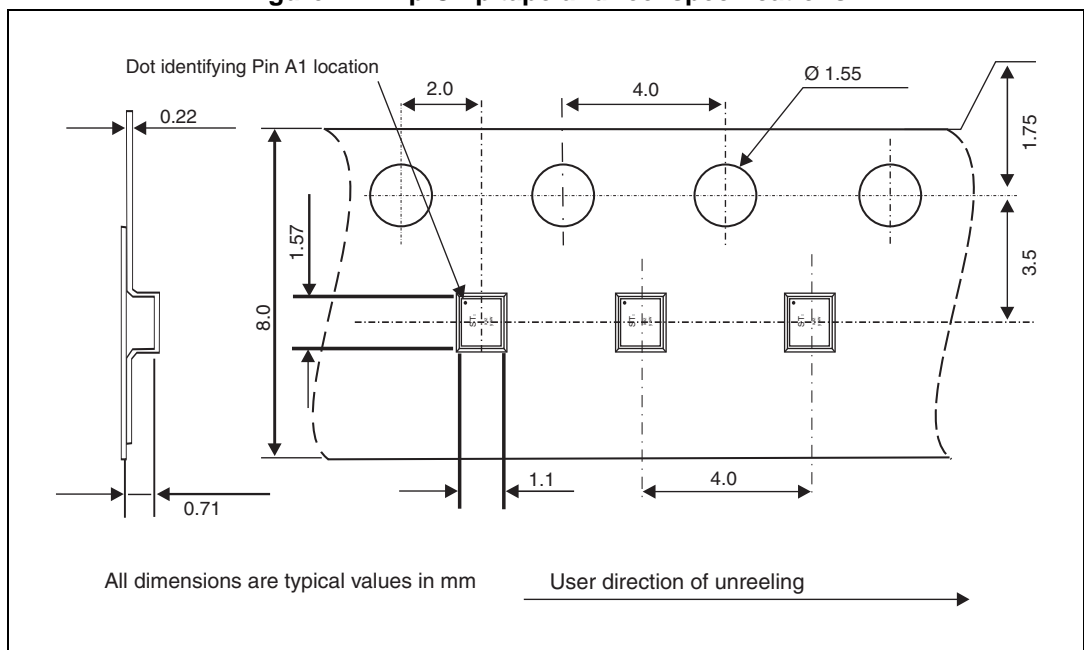

Figure 14. Flip Chip tape and reel specifications



Note: More information is available in the STMicroelectronics Application notes:
AN2348 Flip-Chip: "Package description and recommendations for use"
AN4111: "BAL-NRF01D3 matched balun with integrated harmonics filter for Nordic Semiconductor chips with ultralow power transceivers"

4 Ordering information

Table 4. Ordering information

Order code	Marking	Weight	Base Qty	Delivery mode
BAL-NRF01D3	SC	1.82 mg	5000	Tape and Reel

5 Revision history

Table 5. Document revision history

Date	Revision	Changes
15-Oct-2012	1	Initial release
13-Nov-2012	2	Added references to nRF51 series. Added Figure 9 . Updated y-axis labels in Figure 2 .
04-Mar-2013	3	Updated footprint illustrations in Figure 11 , and Figure 12 .

Please Read Carefully:

Information in this document is provided solely in connection with ST products. STMicroelectronics NV and its subsidiaries ("ST") reserve the right to make changes, corrections, modifications or improvements, to this document, and the products and services described herein at any time, without notice.

All ST products are sold pursuant to ST's terms and conditions of sale.

Purchasers are solely responsible for the choice, selection and use of the ST products and services described herein, and ST assumes no liability whatsoever relating to the choice, selection or use of the ST products and services described herein.

No license, express or implied, by estoppel or otherwise, to any intellectual property rights is granted under this document. If any part of this document refers to any third party products or services it shall not be deemed a license grant by ST for the use of such third party products or services, or any intellectual property contained therein or considered as a warranty covering the use in any manner whatsoever of such third party products or services or any intellectual property contained therein.

UNLESS OTHERWISE SET FORTH IN ST'S TERMS AND CONDITIONS OF SALE ST DISCLAIMS ANY EXPRESS OR IMPLIED WARRANTY WITH RESPECT TO THE USE AND/OR SALE OF ST PRODUCTS INCLUDING WITHOUT LIMITATION IMPLIED WARRANTIES OF MERCHANTABILITY, FITNESS FOR A PARTICULAR PURPOSE (AND THEIR EQUIVALENTS UNDER THE LAWS OF ANY JURISDICTION), OR INFRINGEMENT OF ANY PATENT, COPYRIGHT OR OTHER INTELLECTUAL PROPERTY RIGHT.

ST PRODUCTS ARE NOT AUTHORIZED FOR USE IN WEAPONS. NOR ARE ST PRODUCTS DESIGNED OR AUTHORIZED FOR USE IN: (A) SAFETY CRITICAL APPLICATIONS SUCH AS LIFE SUPPORTING, ACTIVE IMPLANTED DEVICES OR SYSTEMS WITH PRODUCT FUNCTIONAL SAFETY REQUIREMENTS; (B) AERONAUTIC APPLICATIONS; (C) AUTOMOTIVE APPLICATIONS OR ENVIRONMENTS, AND/OR (D) AEROSPACE APPLICATIONS OR ENVIRONMENTS. WHERE ST PRODUCTS ARE NOT DESIGNED FOR SUCH USE, THE PURCHASER SHALL USE PRODUCTS AT PURCHASER'S SOLE RISK, EVEN IF ST HAS BEEN INFORMED IN WRITING OF SUCH USAGE, UNLESS A PRODUCT IS EXPRESSLY DESIGNATED BY ST AS BEING INTENDED FOR "AUTOMOTIVE, AUTOMOTIVE SAFETY OR MEDICAL" INDUSTRY DOMAINS ACCORDING TO ST PRODUCT DESIGN SPECIFICATIONS. PRODUCTS FORMALLY ESCC, QML OR JAN QUALIFIED ARE DEEMED SUITABLE FOR USE IN AEROSPACE BY THE CORRESPONDING GOVERNMENTAL AGENCY.

Resale of ST products with provisions different from the statements and/or technical features set forth in this document shall immediately void any warranty granted by ST for the ST product or service described herein and shall not create or extend in any manner whatsoever, any liability of ST.

ST and the ST logo are trademarks or registered trademarks of ST in various countries.

Information in this document supersedes and replaces all information previously supplied.

The ST logo is a registered trademark of STMicroelectronics. All other names are the property of their respective owners.

© 2013 STMicroelectronics - All rights reserved

STMicroelectronics group of companies

Australia - Belgium - Brazil - Canada - China - Czech Republic - Finland - France - Germany - Hong Kong - India - Israel - Italy - Japan - Malaysia - Malta - Morocco - Philippines - Singapore - Spain - Sweden - Switzerland - United Kingdom - United States of America

www.st.com

