

# DATA SHEET

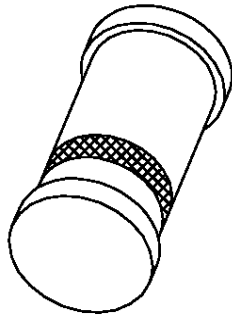

## **BZV55 series** Voltage regulator diodes

Product specification  
Supersedes data of November 1993  
File under Discrete Semiconductors, SC01

1996 Apr 26

# Voltage regulator diodes

# BZV55 series

### FEATURES

- Total power dissipation: max. 500 mW
- Three tolerance series:  $\pm 2\%$ ,  $\pm 3\%$  and  $\pm 5\%$
- Working voltage range: nom. 2.4 to 75 V (E24 range)
- Non-repetitive peak reverse power dissipation: max. 40 W.

### APPLICATIONS

- Low-power voltage stabilizers or voltage references.

### DESCRIPTION

Low-power voltage regulator diodes in small hermetically sealed glass SOD80C SMD packages. The diodes are available in the normalized E24  $\pm 2\%$  (BZV55-B),  $\pm 3\%$  (BZV55-F) and  $\pm 5\%$  (BZV55-C) tolerance range. The series consists of 37 types with nominal working voltages from 2.4 to 75 V.

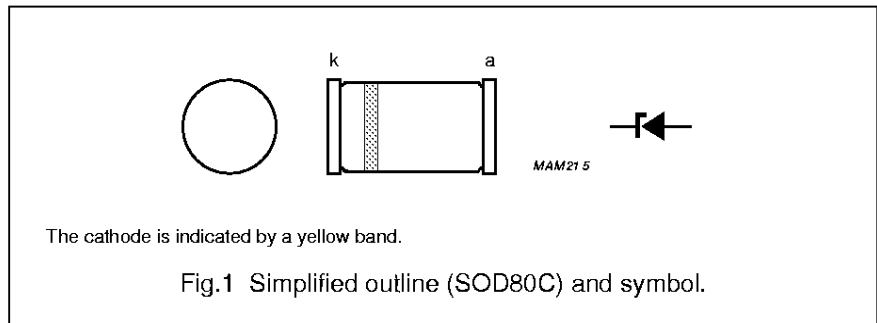

### LIMITING VALUES

In accordance with the Absolute Maximum Rating System (IEC 134).

SYMBOL	PARAMETER	CONDITIONS	MIN.	MAX.	UNIT
$I_F$	continuous forward current		–	250	mA
$I_{ZSM}$	non-repetitive peak reverse current	$t_p = 100 \mu s$ ; square wave; $T_j = 25 \text{ }^\circ\text{C}$ prior to surge	see Tables 1 and 2		
$P_{tot}$	total power dissipation	$T_{amb} \leq 50 \text{ }^\circ\text{C}$ ; note 1	–	400	mW
		tie-point $\leq 50 \text{ }^\circ\text{C}$ ; note 1	–	500	mW
$P_{ZSM}$	non-repetitive peak reverse power dissipation	$t_p = 100 \mu s$ ; square wave; $T_j = 25 \text{ }^\circ\text{C}$ prior to surge; see Fig.3	–	40	W
$T_{stg}$	storage temperature		–65	+200	$^\circ\text{C}$
$T_j$	junction temperature		–65	+200	$^\circ\text{C}$

### Note

1. Device mounted on a ceramic substrate of  $10 \times 10 \times 0.6 \text{ mm}$ .

Voltage regulator diodes

BZV55 series

**ELECTRICAL CHARACTERISTICS**

**Total BZV55-B, F and C series**

$T_j = 25\text{ }^\circ\text{C}$ ; unless otherwise specified.

SYMBOL	PARAMETER	CONDITIONS	MAX.	UNIT
$V_F$	forward voltage	$I_F = 10\text{ mA}$ ; see Fig.4	0.9	V
$I_R$	reverse current			
	BZV55-B/F/C2V4	$V_R = 1\text{ V}$	50	$\mu\text{A}$
	BZV55-B/F/C2V7	$V_R = 1\text{ V}$	20	$\mu\text{A}$
	BZV55-B/F/C3V0	$V_R = 1\text{ V}$	10	$\mu\text{A}$
	BZV55-B/F/C3V3	$V_R = 1\text{ V}$	5	$\mu\text{A}$
	BZV55-B/F/C3V6	$V_R = 1\text{ V}$	5	$\mu\text{A}$
	BZV55-B/F/C3V9	$V_R = 1\text{ V}$	3	$\mu\text{A}$
	BZV55-B/F/C4V3	$V_R = 1\text{ V}$	3	$\mu\text{A}$
	BZV55-B/F/C4V7	$V_R = 2\text{ V}$	3	$\mu\text{A}$
	BZV55-B/F/C5V1	$V_R = 2\text{ V}$	2	$\mu\text{A}$
	BZV55-B/F/C5V6	$V_R = 2\text{ V}$	1	$\mu\text{A}$
	BZV55-B/F/C6V2	$V_R = 4\text{ V}$	3	$\mu\text{A}$
	BZV55-B/F/C6V8	$V_R = 4\text{ V}$	2	$\mu\text{A}$
	BZV55-B/F/C7V5	$V_R = 5\text{ V}$	1	$\mu\text{A}$
	BZV55-B/F/C8V2	$V_R = 5\text{ V}$	700	nA
	BZV55-B/F/C9V1	$V_R = 6\text{ V}$	500	nA
	BZV55-B/F/C10	$V_R = 7\text{ V}$	200	nA
BZV55-B/F/C11	$V_R = 8\text{ V}$	100	nA	
BZV55-B/F/C12	$V_R = 8\text{ V}$	100	nA	
BZV55-B/F/C13	$V_R = 8\text{ V}$	100	nA	
BZV55-B/F/C15 to 75	$V_R = 0.7V_{Znom}$	50	nA	

Voltage regulator diodes

BZV55 series

**Table 1** Per type BZV55-B/F/C2V4 to B/F/C24  
 $T_J = 25\text{ }^\circ\text{C}$ ; unless otherwise specified.

BZV55-B or F or C XXX	WORKING VOLTAGE $V_Z$ (V) at $I_{Z\text{test}} = 5\text{ mA}$						DIFFERENTIAL RESISTANCE $r_{\text{diff}}$ ( $\Omega$ )				TEMP. COEFF. $S_Z$ (mV/K) at $I_{Z\text{test}} = 5\text{ mA}$ (see Figs 5 and 6)		DIODE CAP. $C_d$ (pF) at $f = 1\text{ MHz}$ ; $V_R = 0\text{ V}$	NON-REPETITIVE PEAK REVERSE CURRENT $I_{ZSM}$ (A) at $t_p = 100\text{ }\mu\text{s}$ ; $T_{\text{amb}} = 25\text{ }^\circ\text{C}$	
	Tol. $\pm 2\%$ (B)		Tol. $\pm 3\%$ (F)		Tol. $\pm 5\%$ (C)		at $I_{Z\text{test}} = 1\text{ mA}$		at $I_{Z\text{test}} = 5\text{ mA}$		MIN.	TYP.			MAX.
	MIN.	MAX.	MIN.	MAX.	MIN.	MAX.	TYP.	MAX.	TYP.	MAX.					
2V4	2.35	2.45	2.33	2.47	2.2	2.6	275	600	70	100	-3.5	-1.6	0	450	6.0
2V7	2.65	2.75	2.62	2.78	2.5	2.9	300	600	75	100	-3.5	-2.0	0	450	6.0
3V0	2.94	3.06	2.91	3.09	2.8	3.2	325	600	80	95	-3.5	-2.1	0	450	6.0
3V3	3.23	3.37	3.20	3.40	3.1	3.5	350	600	85	95	-3.5	-2.4	0	450	6.0
3V6	3.53	3.67	3.49	3.71	3.4	3.8	375	600	85	90	-3.5	-2.4	0	450	6.0
3V9	3.82	3.98	3.78	4.02	3.7	4.1	400	600	85	90	-3.5	-2.5	0	450	6.0
4V3	4.21	4.39	4.17	4.43	4.0	4.6	410	600	80	90	-3.5	-2.5	0	450	6.0
4V7	4.61	4.79	4.56	4.84	4.4	5.0	425	500	50	80	-3.5	-1.4	0.2	300	6.0
5V1	5.00	5.20	4.95	5.25	4.8	5.4	400	480	40	60	-2.7	-0.8	1.2	300	6.0
5V6	5.49	5.71	5.43	5.77	5.2	6.0	80	400	15	40	-2.0	1.2	2.5	300	6.0
6V2	6.08	6.32	6.01	6.39	5.8	6.6	40	150	6	10	0.4	2.3	3.7	200	6.0
6V8	6.66	6.94	6.60	7.00	6.4	7.2	30	80	6	15	1.2	3.0	4.5	200	6.0
7V5	7.35	7.65	7.28	7.72	7.0	7.9	30	80	6	15	2.5	4.0	5.3	150	4.0
8V2	8.04	8.36	7.95	8.45	7.7	8.7	40	80	6	15	3.2	4.6	6.2	150	4.0
9V1	8.92	9.28	8.83	9.37	8.5	9.6	40	100	6	15	3.8	5.5	7.0	150	3.0
10	9.80	10.20	9.70	10.30	9.4	10.6	50	150	8	20	4.5	6.4	8.0	90	3.0
11	10.80	11.20	10.67	11.33	10.4	11.6	50	150	10	20	5.4	7.4	9.0	85	2.5
12	11.80	12.20	11.64	12.36	11.4	12.7	50	150	10	25	6.0	8.4	10.0	85	2.5
13	12.70	13.30	12.61	13.39	12.4	14.1	50	170	10	30	7.0	9.4	11.0	80	2.5
15	14.70	15.30	14.55	15.45	13.8	15.6	50	200	10	30	9.2	11.4	13.0	75	2.0
16	15.70	16.30	15.50	16.50	15.3	17.1	50	200	10	40	10.4	12.4	14.0	75	1.5
18	17.60	18.40	17.50	18.50	16.8	19.1	50	225	10	45	12.4	14.4	16.0	70	1.5
20	19.60	20.40	19.40	20.60	18.8	21.2	60	225	15	55	14.4	16.4	18.0	60	1.5
22	21.60	22.40	21.30	22.70	20.8	23.3	60	250	20	55	16.4	18.4	20.0	60	1.25
24	23.50	24.50	23.30	24.70	22.8	25.6	60	250	25	70	18.4	20.4	22.0	55	1.25

Voltage regulator diodes

BZV55 series

**Table 2** Per type BZV55-B/F/C27 to B/F/C75  
 $T_J = 25\text{ }^\circ\text{C}$ ; unless otherwise specified.

BZV55-B or F or C XXX	WORKING VOLTAGE $V_Z$ (V) at $I_{Ztest} = 2\text{ mA}$						DIFFERENTIAL RESISTANCE $r_{diff}$ ( $\Omega$ )				TEMP. COEFF. $S_Z$ (mV/K) at $I_{Ztest} = 2\text{ mA}$ (see Figs 5 and 6)			DIODE CAP. $C_d$ (pF) at $f = 1\text{ MHz}$ ; $V_R = 0\text{ V}$	NON-REPETITIVE PEAK REVERSE CURRENT $I_{ZSM}$ (A) at $t_p = 100\text{ }\mu\text{s}$ ; $T_{amb} = 25\text{ }^\circ\text{C}$
	Tol. $\pm 2\%$ (B)		Tol. $\pm 3\%$ (F)		Tol. $\pm 5\%$ (C)		at $I_{Ztest} = 0.5\text{ mA}$		at $I_{Ztest} = 2\text{ mA}$		MIN.	TYP.	MAX.		
	MIN.	MAX.	MIN.	MAX.	MIN.	MAX.	TYP.	MAX.	MIN.	TYP.					
27	26.50	27.50	26.20	27.80	25.1	28.9	65	300	25	80	21.4	23.4	25.3	50	1.0
30	29.40	30.60	29.10	30.90	28.0	32.0	70	300	30	80	24.4	26.6	29.4	50	1.0
33	32.30	33.70	32.00	34.00	31.0	35.0	75	325	35	80	27.4	29.7	33.4	45	0.9
36	35.30	36.70	34.90	37.10	34.0	38.0	80	350	35	90	30.4	33.0	37.4	45	0.8
39	38.20	39.80	37.80	40.20	37.0	41.0	80	350	40	130	33.4	36.4	41.2	45	0.7
43	42.10	43.90	41.70	44.30	40.0	46.0	85	375	45	150	37.6	41.2	46.6	40	0.6
47	46.10	47.90	45.60	48.40	44.0	50.0	85	375	50	170	42.0	46.1	51.8	40	0.5
51	50.00	52.00	49.50	52.50	48.0	54.0	90	400	60	180	46.6	51.0	57.2	40	0.4
56	54.90	57.10	54.30	57.70	52.0	60.0	100	425	70	200	52.2	57.0	63.8	40	0.3
62	60.80	63.20	60.10	63.90	58.0	66.0	120	450	80	215	58.8	64.4	71.6	35	0.3
68	66.60	69.40	66.00	70.00	64.0	72.0	150	475	90	240	65.6	71.7	79.8	35	0.25
75	73.50	76.50	72.80	77.20	70.0	79.0	170	500	95	255	73.4	80.2	88.6	35	0.2

## Voltage regulator diodes

## BZV55 series

**THERMAL CHARACTERISTICS**

<b>SYMBOL</b>	<b>PARAMETER</b>	<b>CONDITIONS</b>	<b>VALUE</b>	<b>UNIT</b>
$R_{th\ j-tp}$	thermal resistance from junction to tie-point		300	K/W
$R_{th\ j-a}$	thermal resistance from junction to ambient	see Fig.2 and note 1	380	K/W

**Note**

1. Device mounted on a ceramic substrate of 10 × 10 × 0.6 mm.

Voltage regulator diodes

BZV55 series

GRAPHICAL DATA

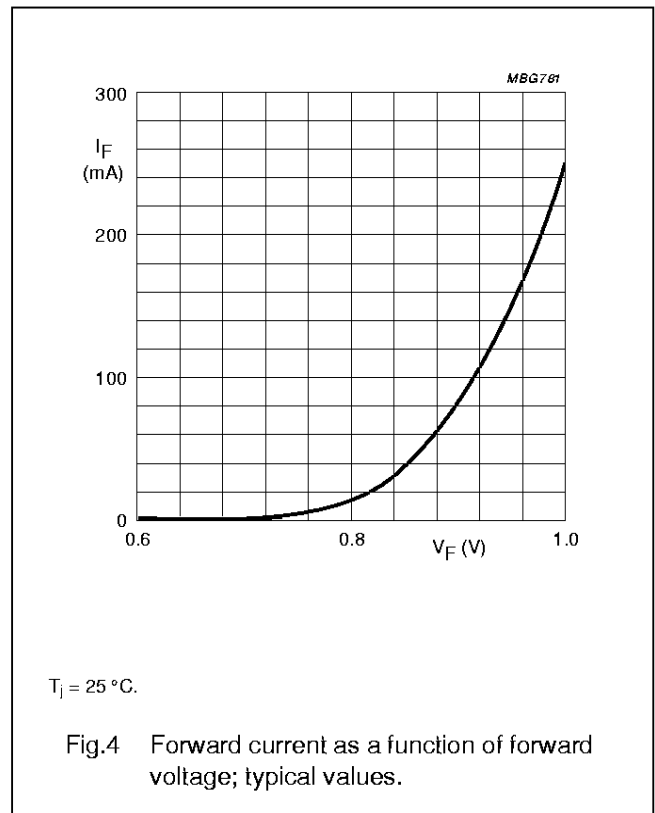
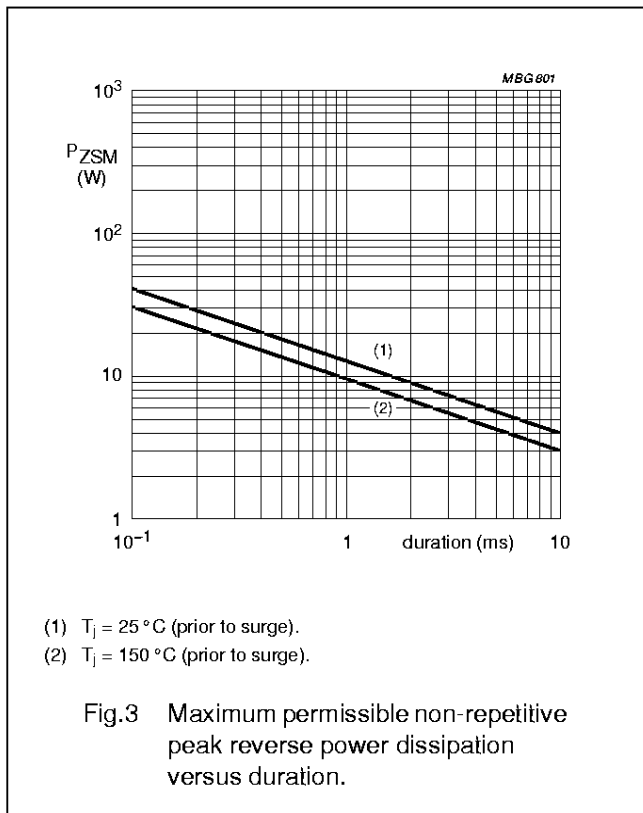

Voltage regulator diodes

BZV55 series

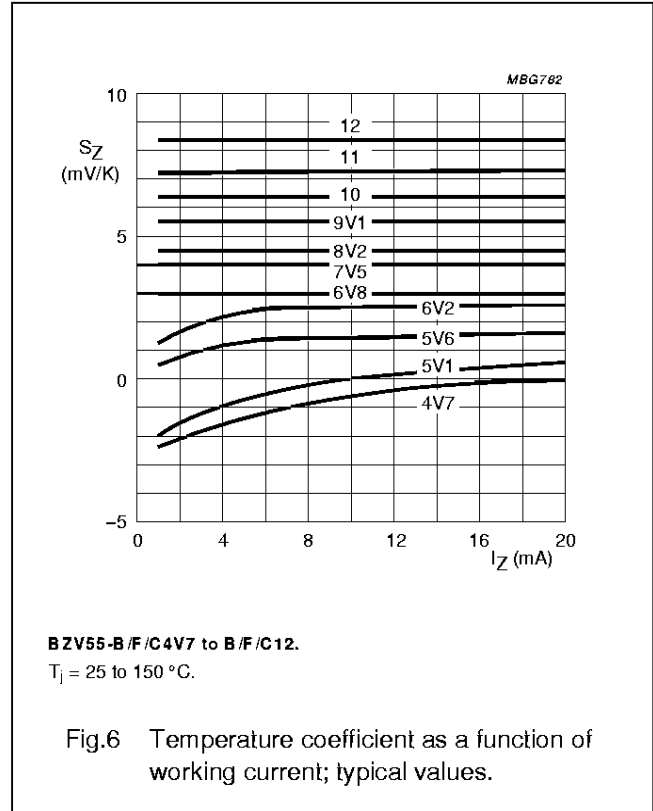
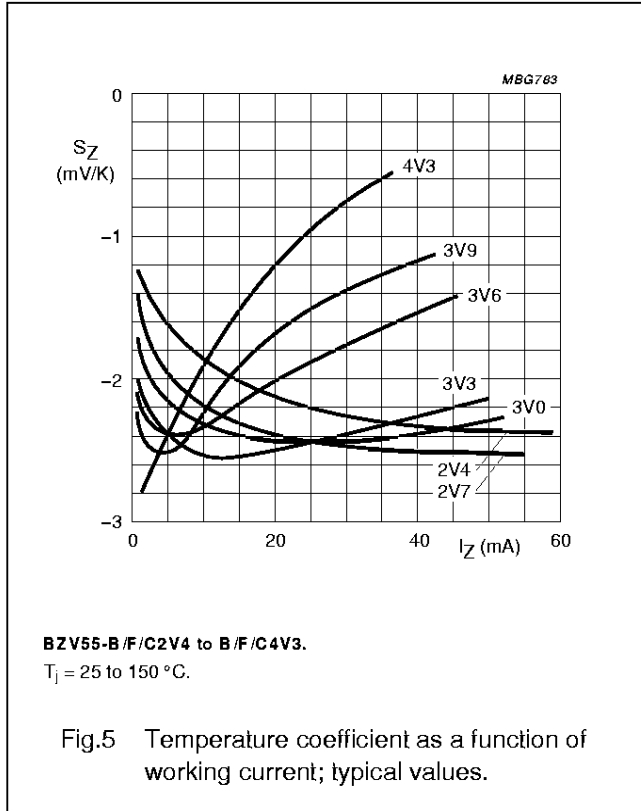



Voltage regulator diodes

BZV55 series

**PACKAGE OUTLINE**

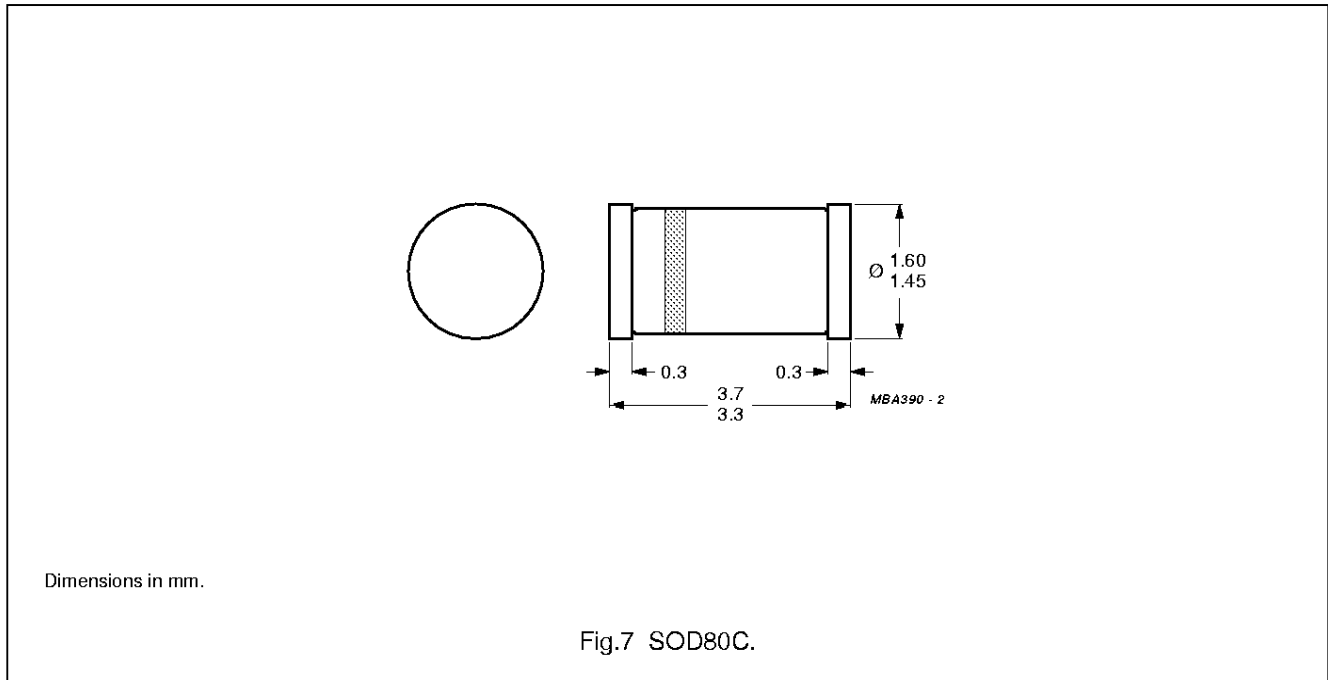

**DEFINITIONS**

<b>Data sheet status</b>	
Objective specification	This data sheet contains target or goal specifications for product development.
Preliminary specification	This data sheet contains preliminary data; supplementary data may be published later.
Product specification	This data sheet contains final product specifications.
<b>Limiting values</b>	
Limiting values given are in accordance with the Absolute Maximum Rating System (IEC 134). Stress above one or more of the limiting values may cause permanent damage to the device. These are stress ratings only and operation of the device at these or at any other conditions above those given in the Characteristics sections of the specification is not implied. Exposure to limiting values for extended periods may affect device reliability.	
<b>Application information</b>	
Where application information is given, it is advisory and does not form part of the specification.	

**LIFE SUPPORT APPLICATIONS**

These products are not designed for use in life support appliances, devices, or systems where malfunction of these products can reasonably be expected to result in personal injury. Philips customers using or selling these products for use in such applications do so at their own risk and agree to fully indemnify Philips for any damages resulting from such improper use or sale.