

ASSP Mobile Communication Systems

Piezoelectric SAW BPF (700 to 1000 MHz)

F5/F6 Series (K2 type)

■ DESCRIPTION

The F5CE/F6CE-K2 series of SAW band pass filters are available in the 700-1700 MHz frequency range and exhibit high stability by using single crystal Lithium Tantalate (LiTaO_3) with a large electro-mechanical coefficient. The F5CE/F6CE-K2 series provides low insertion loss and wide passband width by taking advantage of Fujitsu's unique "Ladder-type" design.

The F5CE/F6CE-K2 series is housed in a small package (3.0 mm square) contributing to a significant savings in mounting space. This package is 40 % smaller than our F5CH-L2 series (3.8 mm square). Typical applications for the F5CE/F6CE-K2 series include RF interstage filtering in mobile communications systems. Standard devices are available for AMPS/TDMA/CDMA, GSM, EGSM and various Japanese standards. If higher attenuation is preferred, our F5CE-D2 series is also recommended.

■ FEATURES

- Low insertion loss and high stopband attenuation
- Wide pass band width
- Compact and light package (3.0 mm sq.)
- External matching circuits are not required. (50 ohms I/O)
- Surface mount package (SMT)
- Standard devices are available for mobile communication standards (AMPS/CDMA/TDMA, GSM, EGSM, PDC800, cdmaOne, CDMA, PDC 1.5 G)

■ PACKAGE

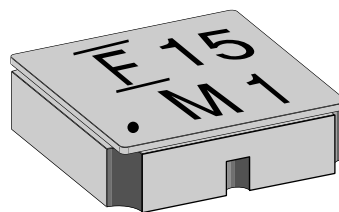

F5/F6 Series (K2 type)

■ PIN ASSIGNMENT

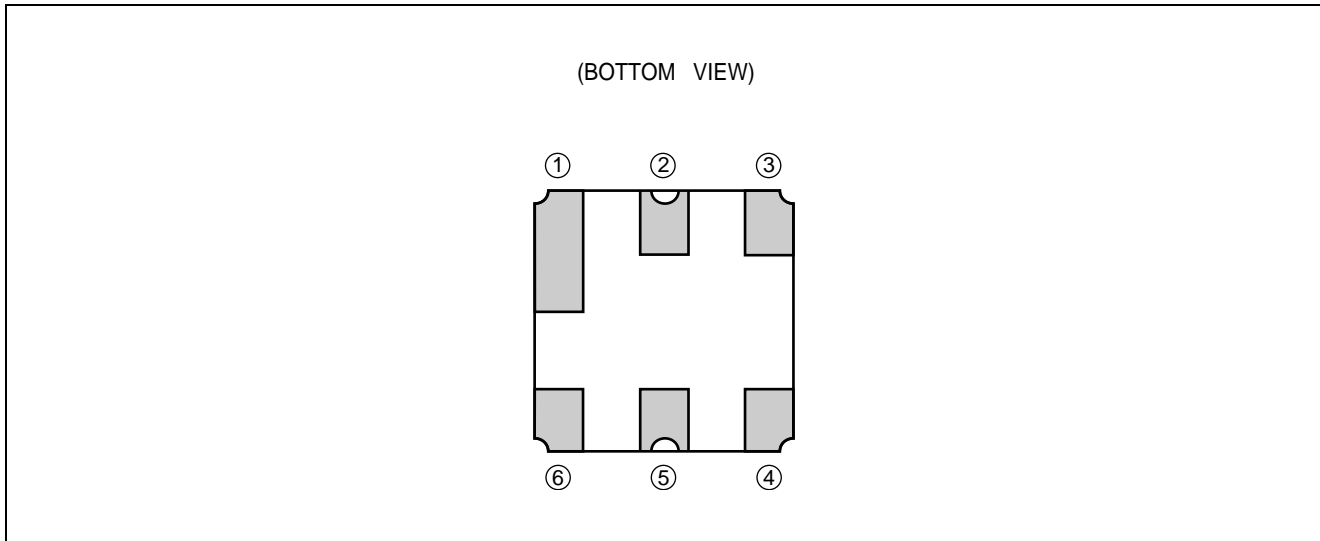

■ PIN DESCRIPTION

Pin No.	Pin name	Description
1	GND	Ground Pin
2	IN	Input Pin
3	GND	Ground Pin
4	GND	Ground Pin
5	OUT	Output Pin
6	GND	Ground Pin

■ ABSOLUTE MAXIMUM RATINGS

Parameter	Symbol	Rating		Unit
		Min.	Max.	
Operating temperature	Ta	-30	+85	°C
Storage temperature	Tstg	-40	+100	°C
Input level	P _{IN}	—	+23	dBm
Input DC voltage	DC	-5	+5	V
Input ESD voltage	ESD	-50	+50	V

WARNING: Piezoelectric devices can be permanently damaged by application of stress (power, temperature, etc.) in excess of absolute maximum ratings. Do not exceed these ratings.

F5/F6 Series (K2 type)

RECOMMENDED OPERATING CONDITIONS

Parameter	Symbol	Value		Unit
		Min.	Max.	
Operating temperature	Ta	-30	+85	°C

WARNING: The recommended operating conditions are required in order to ensure the normal operation of the piezoelectric device. All of the device's electrical characteristics are warranted when the device is operated within these ranges.

Always use piezoelectric devices within their recommended operating condition ranges. Operation outside these ranges may adversely affect reliability and could result in device failure.

No warranty is made with respect to uses, operating conditions, or combinations not represented on the data sheet. Users considering application outside the listed conditions are advised to contact their FUJITSU representatives beforehand.

STANDARD FREQUENCIES

System		Center freq. (MHz)	B/W (MHz)	Part symbol	Part number	Remarks
AMPS /TDMA /CDMA	Tx	836.5	25	25	FAR-F5CE-836M50-K225	Low loss type
		836.5	25	30	FAR-F5CE-836M50-K230	High Att. type
	Rx	881.5	25	87	FAR-F5CE-881M50-K287	Low loss type
		881.5	25	10	FAR-F5CE-881M50-K210	High Att. type
GSM	Tx	902.5	25	13	FAR-F5CE-902M50-K213	
	Rx	947.5	25	33	FAR-F5CE-947M50-K233	Ultra low loss
		947.5	25	14	FAR-F5CE-947M50-K214	Low loss type
		947.5	25	28	FAR-F5CE-947M50-K228	High Att. type
EGSM	Tx	897.5	35	26	FAR-F5CE-897M50-K226	
	Rx	942.5	35	88	FAR-F5CE-942M50-K288	Low loss type
		942.5	35	16	FAR-F5CE-942M50-K216	
PDC800 (20 MHz passband width standard)	Tx	950.0	20	01	FAR-F5CE-950M00-K201	
	Rx	820.0	20	02	FAR-F5CE-820M00-K202	Low loss type
		820.0	20	04	FAR-F5CE-820M00-K204	High Att. type
cdmaOne	Tx	906.0	38	11	FAR-F5CE-906M00-K211	Low loss type
		906.0	38	19	FAR-F5CE-906M00-K219	
		906.0	38	15	FAR-F5CE-906M00-K215	High Att. type
	Rx	851.0	38	12	FAR-F5CE-851M00-K212	
PDC1.5 G	Tx	1441.0	24	23	FAR-F6CE-1G4410-K223	Low loss type
		1441.0	24	20	FAR-F6CE-1G4410-K220	
	Rx	1489.0	24	24	FAR-F6CE-1G4890-K224	Low loss type
		1489.0	24	21	FAR-F6CE-1G4890-K221	

F5/F6 Series (K2 type)

■ ELECTRICAL CHARACTERISTICS

1. AMPS/TDMA/CDMA (Tx) Low Loss type

Part number: FAR-F5CE-836M50-K225

(Ta = -30 to +85°C)

Parameter	Symbol	Conditions	Value			Unit	Remarks
			Min.	Typ.	Max.		
Insertion loss	IL	824 to 849 MHz	—	2.0	2.5	dB	
Inband ripple	—	824 to 849 MHz	—	0.9	1.5	dB	
Absolute attenuation	—	DC to 800 MHz	20	23	—	dB	
	—	869 to 894 MHz	28	30	—	dB	
	—	894 to 2000 MHz	22	25	—	dB	
Inband VSWR (Return loss)	— (RL)	824 to 849 MHz	— (6.2)	2.6 (7.0)	2.9 (—)	— (dB)	

2. AMPS/TDMA/CDMA (Tx) High Attenuation type

Part number: FAR-F5CE-836M50-K230

(Ta = -30 to +85°C)

Parameter	Symbol	Conditions	Value			Unit	Remarks
			Min.	Typ.	Max.		
Insertion loss	IL	824 to 849 MHz	—	2.7	3.5	dB	
Inband ripple	—	824 to 849 MHz	—	1.0	2.0	dB	
Absolute attenuation	—	DC to 800 MHz	28	30	—	dB	
	—	869 to 894 MHz	30	43	—	dB	
	—	894 to 1200 MHz	35	37	—	dB	
	—	1200 to 2000 MHz	20	25	—	dB	
Inband VSWR (Return loss)	— (RL)	824 to 849 MHz	— (8.4)	1.7 (12.3)	2.2 (—)	— (dB)	

F5/F6 Series (K2 type)

3. AMPS/TDMA/CDMA (Rx) Low Loss type

Part number: FAR-F5CE-881M50-K287

(Ta = -30 to +85°C)

Parameter	Symbol	Conditions	Value			Unit	Remarks
			Min.	Typ.	Max.		
Insertion loss	IL	869 to 881 MHz	—	2.0	3.0	dB	
Inband ripple	—	869 to 881 MHz	—	0.6	1.5	dB	
Absolute attenuation	—	DC to 800 MHz	20	25	—	dB	
	—	824 to 849 MHz	30	38	—	dB	
	—	939 to 1200 MHz	30	33	—	dB	
	—	1200 to 2000 MHz	20	23	—	dB	
Inband VSWR (Return loss)	— (RL)	869 to 881 MHz	— (8.4)	1.8 (11.2)	2.2 (—)	— (dB)	

4. AMPS/TDMA/CDMA (Rx) High Attenuation type

Part number: FAR-F5CE-881M50-K210

(Ta = -30 to +85°C)

Parameter	Symbol	Conditions	Value			Unit	Remarks
			Min.	Typ.	Max.		
Insertion loss	IL	869 to 894 MHz	—	2.7	3.5	dB	
Inband ripple	—	869 to 894 MHz	—	1.0	2.0	dB	
Absolute attenuation	—	DC to 849 MHz	30	32	—	dB	
	—	914 to 939 MHz	20	38	—	dB	
	—	939 to 1049 MHz	30	35	—	dB	
	—	1049 to 2000 MHz	25	30	—	dB	
Inband VSWR (Return loss)	— (RL)	869 to 894 MHz	— (7.3)	2.0 (9.5)	2.5 (—)	— (dB)	

F5/F6 Series (K2 type)

5. GSM (Tx)

Part number: FAR-F5CE-902M50-K213

(Ta = -30 to +85°C)

Parameter	Symbol	Conditions	Value			Unit	Remarks
			Min.	Typ.	Max.		
Insertion loss	IL	890 to 915 MHz	—	3.0	3.5	dB	
Inband ripple	—	890 to 915 MHz	—	1.0	2.0	dB	
Absolute attenuation	—	DC to 845 MHz	30	32	—	dB	
	—	845 to 870 MHz	20	35	—	dB	
	—	935 to 980 MHz	20	35	—	dB	
	—	980 to 1200 MHz	35	37	—	dB	
	—	1200 to 2000 MHz	30	35	—	dB	
Inband VSWR (Return loss)	— (RL)	890 to 915 MHz	— (7.3)	2.0 (9.5)	2.5 (—)	— (dB)	

6. GSM (Rx) Ultra Low Loss type

Part number: FAR-F5CE-947M50-K233

(Ta = -30 to +85°C)

Parameter	Symbol	Conditions	Value			Unit	Remarks
			Min.	Typ.	Max.		
Insertion loss	IL	935 to 960 MHz	—	1.7	2.0	dB	
Inband ripple	—	935 to 960 MHz	—	0.5	1.0	dB	
Absolute attenuation	—	DC to 905 MHz	17	19	—	dB	
	—	905 to 915 MHz	15	25	—	dB	
	—	980 to 1000 MHz	10	20	—	dB	
	—	1000 to 1500 MHz	18	21	—	dB	
	—	1500 to 2000 MHz	20	25	—	dB	
Inband VSWR (Return loss)	— (RL)	935 to 960 MHz	— (7.3)	2.0 (9.5)	2.5 (—)	— (dB)	

F5/F6 Series (K2 type)

7. GSM (Rx) Low Loss type

Part number: FAR-F5CE-947M50-K214

(Ta = -30 to +85°C)

Parameter	Symbol	Conditions	Value			Unit	Remarks
			Min.	Typ.	Max.		
Insertion loss	IL	935 to 960 MHz	—	2.7	3.0	dB	
Inband ripple	—	935 to 960 MHz	—	1.0	1.5	dB	
Absolute attenuation	—	DC to 800 MHz	20	25	—	dB	
	—	890 to 915 MHz	20	35	—	dB	
	—	980 to 1025 MHz	20	25	—	dB	
	—	1025 to 1600 MHz	27	32	—	dB	
	—	1600 to 2000 MHz	25	30	—	dB	
Inband VSWR (Return loss)	— (RL)	935 to 960 MHz	— (7.3)	2.0 (9.5)	2.5 (—)	— (dB)	

8. GSM (Rx) High Attenuation type

Part number: FAR-F5CE-947M50-K228

(Ta = -30 to +85°C)

Parameter	Symbol	Conditions	Value			Unit	Remarks
			Min.	Typ.	Max.		
Insertion loss	IL	935 to 960 MHz	—	3.0	3.5	dB	
Inband ripple	—	935 to 960 MHz	—	1.0	2.0	dB	
Absolute attenuation	—	DC to 855 MHz	30	32	—	dB	
	—	855 to 871 MHz	32	37	—	dB	
	—	890 to 915 MHz	20	35	—	dB	
	—	980 to 1025 MHz	20	35	—	dB	
	—	1025 to 1105 MHz	33	37	—	dB	
	—	1105 to 2000 MHz	30	37	—	dB	
	—	2000 to 3000 MHz	25	30	—	dB	
Inband VSWR (Return loss)	— (RL)	935 to 960 MHz	— (7.3)	2.0 (9.5)	2.5 (—)	— (dB)	

F5/F6 Series (K2 type)

9. EGSM (Tx)

Part number: FAR-F5CE-897M50-K226

(Ta = -30 to +85°C)

Parameter	Symbol	Conditions	Value			Unit	Remarks
			Min.	Typ.	Max.		
Insertion loss	IL	880 to 915 MHz	—	2.5	3.5	dB	
Inband ripple	—	880 to 915 MHz	—	1.0	2.0	dB	
Absolute attenuation	—	DC to 845 MHz	20	23	—	dB	
	—	925 to 935 MHz	4.5	8	—	dB	Ta = -30 to +25°C
	—		7			dB	Ta = +25 to +85°C
	—	935 to 2000 MHz	25	30	—	dB	
Inband VSWR (Return loss)	— (RL)	880 to 915 MHz	— (6.7)	2.2 (8.4)	2.7 (—)	— (dB)	

10. EGSM (Rx) Low Loss type

Part number: FAR-F5CE-942M50-K288

(Ta = -30 to +85°C)

Parameter	Symbol	Conditions	Value			Unit	Remarks
			Min.	Typ.	Max.		
Insertion loss	IL	925 to 960 MHz	—	2.0	2.5	dB	Ta = +25 ± 2°C
					2.7	dB	Ta = -10 to +60°C
					3.0	dB	Ta = -30 to +85°C
Inband ripple	—	925 to 960 MHz	—	0.5	1.5	dB	
Absolute attenuation	—	DC to 905 MHz	17	18	—	dB	
	—	905 to 915 MHz	13	16	—	dB	Ta = +25 ± 2°C
	—		8			dB	Ta = -10 to +60°C
	—		5			dB	Ta = -30 to +85°C
	—	980 to 1000 MHz	13	20	—	dB	
	—	1000 to 2000 MHz	20	22	—	dB	
Inband VSWR (Return loss)	— (RL)	925 to 960 MHz	— (6.7)	2.2 (8.4)	2.7 (—)	— (dB)	

F5/F6 Series (K2 type)

11. EGSM (Rx)

Part number: FAR-F5CE-942M50-K216

(Ta = -30 to +85°C)

Parameter	Symbol	Conditions	Value			Unit	Remarks
			Min.	Typ.	Max.		
Insertion loss	IL	925 to 960 MHz	—	2.5	3.0	dB	Ta = -10 to +60°C
					3.5		Ta = -30 to +85°C
Inband ripple	—	925 to 960 MHz	—	0.8	1.5	dB	
Absolute attenuation	—	DC to 100 MHz	30	33	—	dB	
	—	100 to 700 MHz	25	26	—	dB	
	—	700 to 800 MHz	28	30	—	dB	
	—	800 to 890 MHz	30	35	—	dB	
	—	890 to 905 MHz	20	25	—	dB	
	—	905 to 915 MHz	15	20	—	dB	Ta = +25 ± 2°C
	—		11			dB	Ta = -10 to +60°C
	—		7			dB	Ta = -30 to +85°C
	—	980 to 1000 MHz	20	30	—	dB	
	—	1000 to 1200 MHz	30	35	—	dB	
	—	1200 to 1550 MHz	25	30	—	dB	
	—	1550 to 1950 MHz	20	23	—	dB	
	—	1950 to 2800 MHz	15	20	—	dB	
	—	2800 to 3000 MHz	10	16	—	dB	
Inband VSWR (Return loss)	— (RL)	925 to 960 MHz	— (6.7)	2.6 (8.4)	2.8 (—)	— (dB)	

12. PDC800 (Tx)

Part number: FAR-F5CE-950M00-K201

(Ta = -30 to +85°C)

Parameter	Symbol	Conditions	Value			Unit	Remarks
			Min.	Typ.	Max.		
Insertion loss	IL	940 to 960 MHz	—	3.0	3.5	dB	
Inband ripple	—	940 to 960 MHz	—	1.5	2.0	dB	
Absolute attenuation	—	DC to 680 MHz	30	36	—	dB	
	—	680 to 696 MHz	33	37	—	dB	
	—	810 to 830 MHz	35	40	—	dB	
	—	1015 to 1106 MHz	40	44	—	dB	
	—	1106 to 2000 MHz	30	37	—	dB	
Inband VSWR (Return loss)	— (RL)	940 to 960 MHz	— (7.3)	1.8 (11.2)	2.5 (—)	— (dB)	

F5/F6 Series (K2 type)

13. PDC800 (Rx) Low Loss type

Part number: FAR-F5CE-820M00-K202

(Ta = -30 to +85°C)

Parameter	Symbol	Conditions	Value			Unit	Remarks
			Min.	Typ.	Max.		
Insertion loss	IL	810 to 830 MHz	—	2.1	2.5	dB	
Inband ripple	—	810 to 830 MHz	—	1.4	1.9	dB	
Absolute attenuation	—	DC to 700 MHz	20	24	—	dB	
	—	875 to 1070 MHz	25	28	—	dB	
	—	1070 to 1090 MHz	26	30	—	dB	
	—	1090 to 2000 MHz	20	28	—	dB	
Inband VSWR (Return loss)	— (RL)	810 to 830 MHz	— (9.5)	1.7 (12.3)	2.0 (—)	— (dB)	

14. PDC800 (Rx) High Attenuation type

Part number: FAR-F5CE-820M00-K204

(Ta = -30 to +85°C)

Parameter	Symbol	Conditions	Value			Unit	Remarks
			Min.	Typ.	Max.		
Insertion loss	IL	810 to 830 MHz	—	3.0	3.5	dB	
Inband ripple	—	810 to 830 MHz	—	1.5	2.0	dB	
Absolute attenuation	—	DC to 130 MHz	35	41	—	dB	
	—	130 to 760 MHz	30	34	—	dB	
	—	855 to 875 MHz	35	38	—	dB	
	—	875 to 1090 MHz	33	38	—	dB	
	—	1090 to 2000 MHz	30	38	—	dB	
Inband VSWR (Return loss)	— (RL)	810 to 830 MHz	— (7.3)	2.0 (9.5)	2.5 (—)	— (dB)	

F5/F6 Series (K2 type)

15. cdmaOne (Tx) Low Loss type

Part number: FAR-F5CE-906M00-K211

(Ta = -30 to +85°C)

Parameter	Symbol	Conditions	Value			Unit	Remarks
			Min.	Typ.	Max.		
Insertion loss	IL	887 to 925 MHz	—	2.5	3.5	dB	
Inband ripple	—	887 to 925 MHz	—	1.0	2.0	dB	
Absolute attenuation	—	DC to 720 MHz	17	20	—	dB	
	—	720 to 800 MHz	20	22	—	dB	
	—	832 to 870 MHz	28	30	—	dB	
	—	940 to 942 MHz	15	25	—	dB	
	—	942 to 950 MHz	20	30	—	dB	
	—	950 to 2000 MHz	20	23	—	dB	
Inband VSWR (Return loss)	— (RL)	887 to 925 MHz	— (7.3)	2.3 (8.0)	2.5 (—)	— (dB)	

16. cdmaOne (Tx)

Part number: FAR-F5CE-906M00-K219

(Ta = -30 to +85°C)

Parameter	Symbol	Conditions	Value			Unit	Remarks
			Min.	Typ.	Max.		
Insertion loss	IL	887 to 925 MHz	—	2.7	3.7	dB	
Inband ripple	—	887 to 925 MHz	—	1.0	2.2	dB	
Absolute attenuation	—	DC to 720 MHz	20	22	—	dB	
	—	720 to 800 MHz	20	23	—	dB	
	—	832 to 870 MHz	32	33	—	dB	
	—	940 to 942 MHz	15	25	—	dB	
	—	942 to 950 MHz	20	30	—	dB	
	—	950 to 2000 MHz	20	23	—	dB	
Inband VSWR (Return loss)	— (RL)	887 to 925 MHz	— (6.7)	2.2 (8.4)	2.7 (—)	— (dB)	

F5/F6 Series (K2 type)

17. cdmaOne (Tx) High Attenuation type

Part number: FAR-F5CE-906M00-K215

(Ta = -30 to +85°C)

Parameter	Symbol	Conditions	Value			Unit	Remarks
			Min.	Typ.	Max.		
Insertion loss	IL	887 to 925 MHz	—	3.0	4.5	dB	
Inband ripple	—	887 to 925 MHz	—	1.5	3.0	dB	
Absolute attenuation	—	DC to 720 MHz	25	26	—	dB	
	—	720 to 800 MHz	25	30	—	dB	
	—	832 to 870 MHz	30	35	—	dB	
	—	940 to 942 MHz	20	25	—	dB	
	—	942 to 950 MHz	25	30	—	dB	
	—	950 to 2000 MHz	20	25	—	dB	
Absolute attenuation	—	2000 to 3000 MHz	15	20	—	dB	
	—	2000 to 3000 MHz	15	20	—	dB	
Inband VSWR (Return loss)	(RL)	887 to 925 MHz	(5.2)	(6.0)	(—)	(dB)	

18. cdmaOne (Rx)

Part number: FAR-F5CE-851M00-K212

(Ta = -30 to +85°C)

Parameter	Symbol	Conditions	Value			Unit	Remarks
			Min.	Typ.	Max.		
Insertion loss	IL	832 to 870 MHz	—	2.5	3.5	dB	
Inband ripple	—	832 to 870 MHz	—	1.0	2.0	dB	
Absolute attenuation	—	DC to 170 MHz	20	24	—	dB	
	—	170 to 720 MHz	18	20	—	dB	
	—	720 to 770 MHz	20	22	—	dB	
	—	770 to 815 MHz	25	27	—	dB	
	—	818 MHz	15	40	—	dB	
	—	887 to 897 MHz	20	30	—	dB	
	—	897 to 925 MHz	23	25	—	dB	
	—	925 to 1100 MHz	22	24	—	dB	
Absolute attenuation	—	1100 to 2000 MHz	20	24	—	dB	
	—	1100 to 2000 MHz	20	24	—	dB	
Inband VSWR (Return loss)	(RL)	832 to 870 MHz	(6.0)	(6.7)	(—)	(dB)	

F5/F6 Series (K2 type)

19. PDC1.5 G (Tx) Low Loss type

Part number: FAR-F6CE-1G4410-K223

(Ta = -30 to +85°C)

Parameter	Symbol	Conditions	Value			Unit	Remarks
			Min.	Typ.	Max.		
Insertion loss	IL	1429 to 1453 MHz	—	1.6	2.5	dB	
Inband ripple	—	1429 to 1453 MHz	—	0.5	1.5	dB	
Absolute attenuation	—	DC to 1000 MHz	13	15	—	dB	
	—	1200 to 1335 MHz	15	19	—	dB	
	—	1335 to 1380 MHz	17	25	—	dB	
	—	1477 to 1501 MHz	5	10	—	dB	
	—	1513 to 1607 MHz	15	18	—	dB	
	—	1607 to 1800 MHz	17	20	—	dB	
	—	1820 to 1850 MHz	17	23	—	dB	
Inband VSWR (Return loss)	— (RL)	1429 to 1453 MHz	— (7.3)	2.0 (9.5)	2.5 (—)	— (dB)	

20. PDC1.5 G (Tx) High Attenuation type

Part number: FAR-F6CE-1G4410-K220

(Ta = -30 to +85°C)

Parameter	Symbol	Conditions	Value			Unit	Remarks
			Min.	Typ.	Max.		
Insertion loss	IL	1429 to 1453 MHz	—	2.2	3.2	dB	
Inband ripple	—	1429 to 1453 MHz	—	1.0	2.0	dB	
Absolute attenuation	—	DC to 1380 MHz	25	27	—	dB	
	—	1477 to 1501 MHz	8	18	—	dB	
	—	1501 to 1900 MHz	30	32	—	dB	
	—	1900 to 2906 MHz	18	28	—	dB	
Inband VSWR (Return loss)	— (RL)	1429 to 1453 MHz	— (7.3)	2.1 (8.9)	2.5 (—)	— (dB)	

F5/F6 Series (K2 type)

21. PDC1.5 G (Rx) Low Loss type

Part number: FAR-F6CE-1G4890-K224

(Ta = -30 to +85°C)

Parameter	Symbol	Conditions	Value			Unit	Remarks
			Min.	Typ.	Max.		
Insertion loss	IL	1477 to 1501 MHz	—	1.6	2.3	dB	
Inband ripple	—	1477 to 1501 MHz	—	0.7	1.5	dB	
Absolute attenuation	—	1217 to 1241 MHz	15	18	—	dB	
	—	1347 to 1371 MHz	18	22	—	dB	
	—	1429 to 1453 MHz	10	25	—	dB	
	—	1607 to 1631 MHz	15	20	—	dB	
	—	1737 to 1761 MHz	15	20	—	dB	
Inband VSWR (Return loss)	— (RL)	1477 to 1501 MHz	— (7.3)	2.0 (9.5)	2.5 (—)	— (dB)	

22. PDC1.5 G (Rx) High Attenuation type

Part number: FAR-F6CE-1G4890-K221

(Ta = -30 to +85°C)

Parameter	Symbol	Conditions	Value			Unit	Remarks
			Min.	Typ.	Max.		
Insertion loss	IL	1477 to 1501 MHz	—	2.5	3.0	dB	
Inband ripple	—	1477 to 1501 MHz	—	1.0	2.0	dB	
Absolute attenuation	—	DC to 1429 MHz	25	28	—	dB	
	—	1429 to 1453 MHz	10	25	—	dB	
	—	1542 to 1566 MHz	20	28	—	dB	
	—	1566 to 1900 MHz	30	33	—	dB	
	—	1900 to 3000 MHz	20	29	—	dB	
Inband VSWR (Return loss)	— (RL)	1477 to 1501 MHz	— (6.7)	2.4 (7.7)	2.7 (—)	— (dB)	

F5/F6 Series (K2 type)

TYPICAL CHARACTERISTICS

1. AMPS/TDMA/CDMA (Tx) Low Loss type Part number: FAR-F5CE-836M50-K225

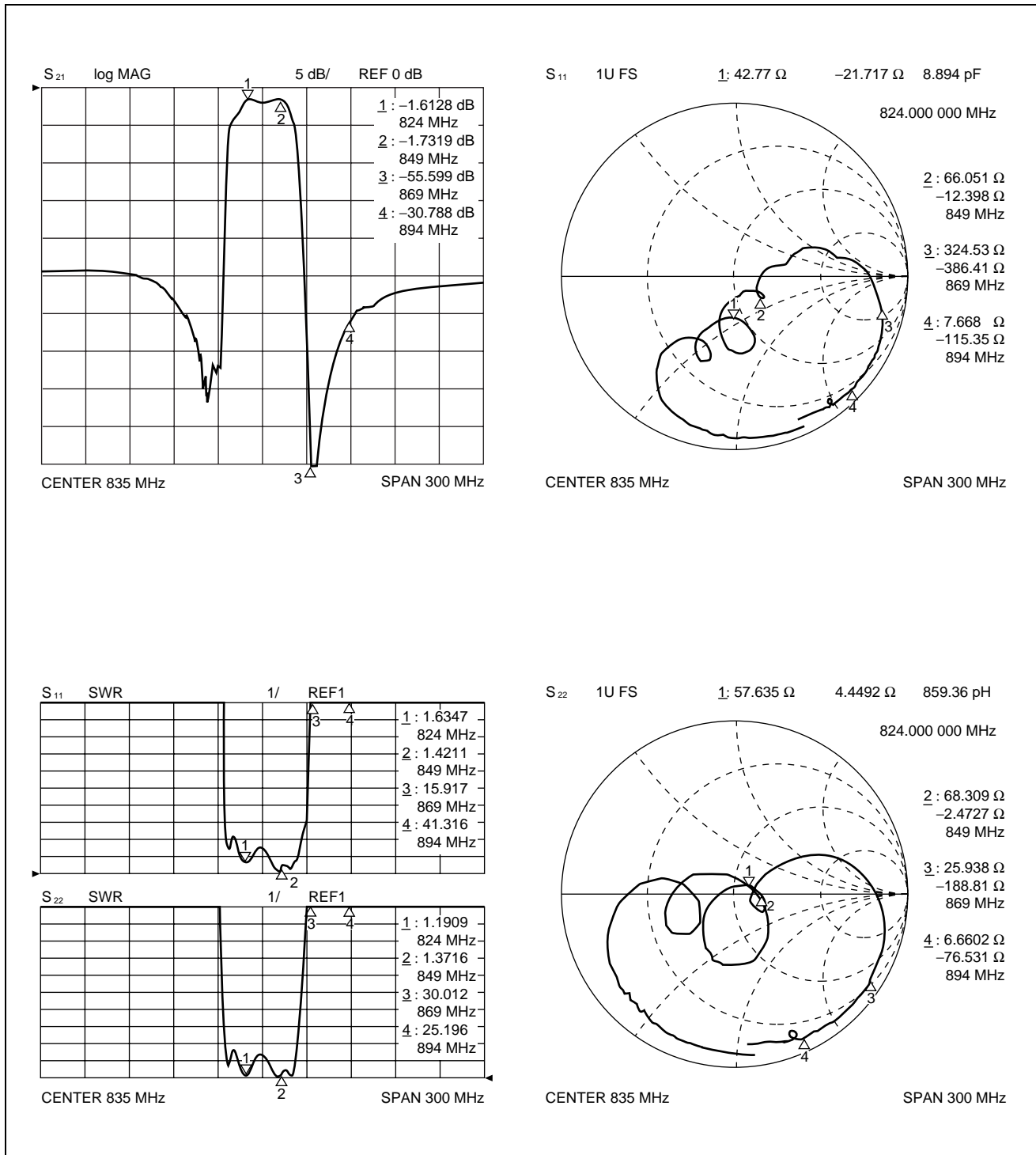

F5/F6 Series (K2 type)

2. AMPS/TDMA/CDMA (Tx) High Attenuation type Part number: FAR-F5CE-836M50-K230

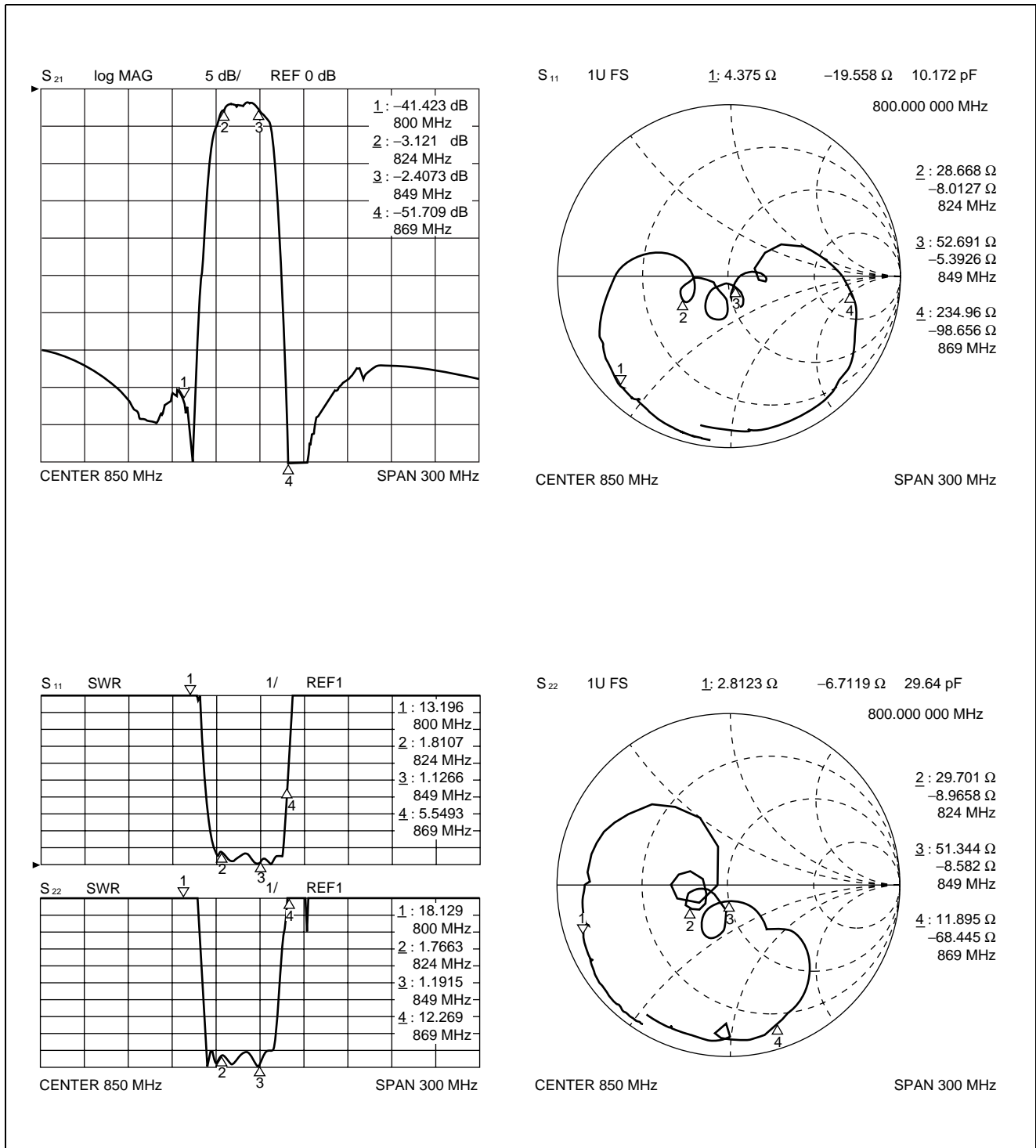

F5/F6 Series (K2 type)

3. AMPS/TDMA/CDMA (Rx) Low Loss type Part number: FAR-F5CE-881M50-K287

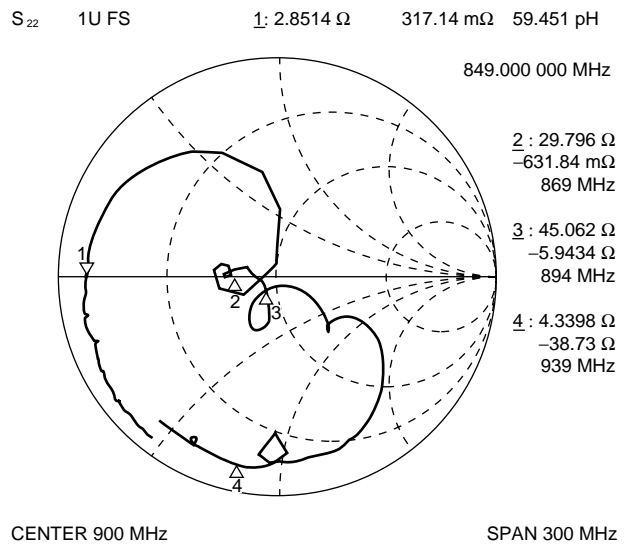
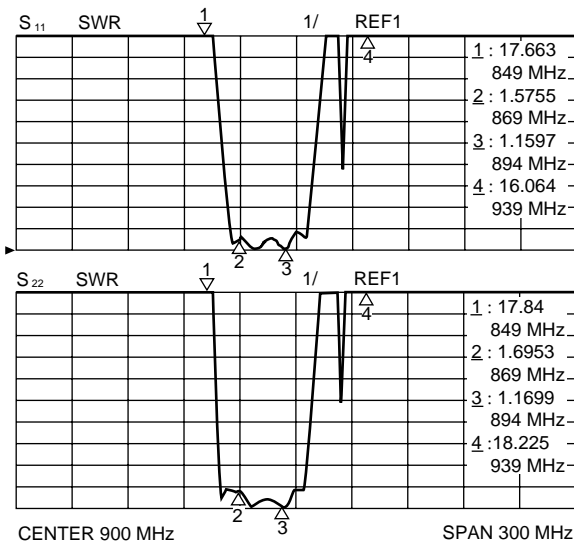
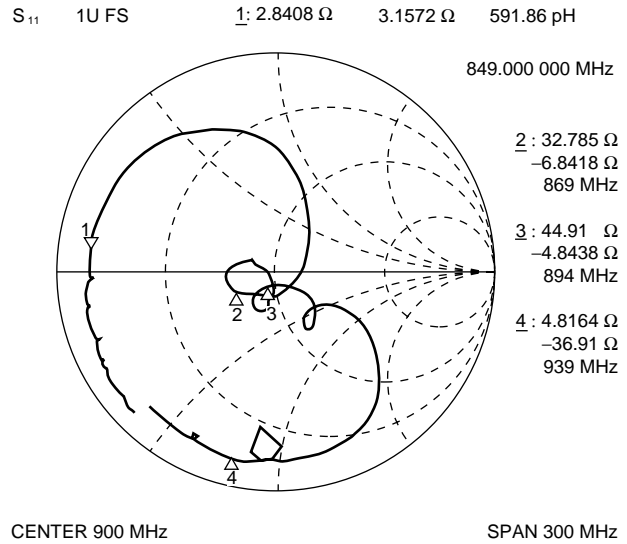
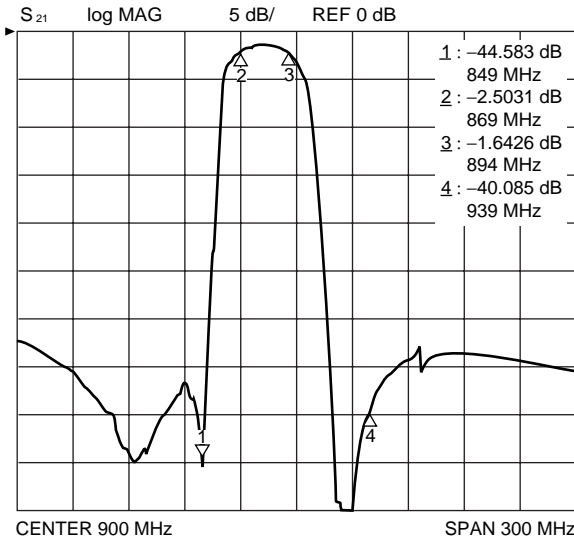

F5/F6 Series (K2 type)

4. AMPS/TDMA/CDMA (Rx) High Attenuation type Part number: FAR-F5CE-881M50-K210

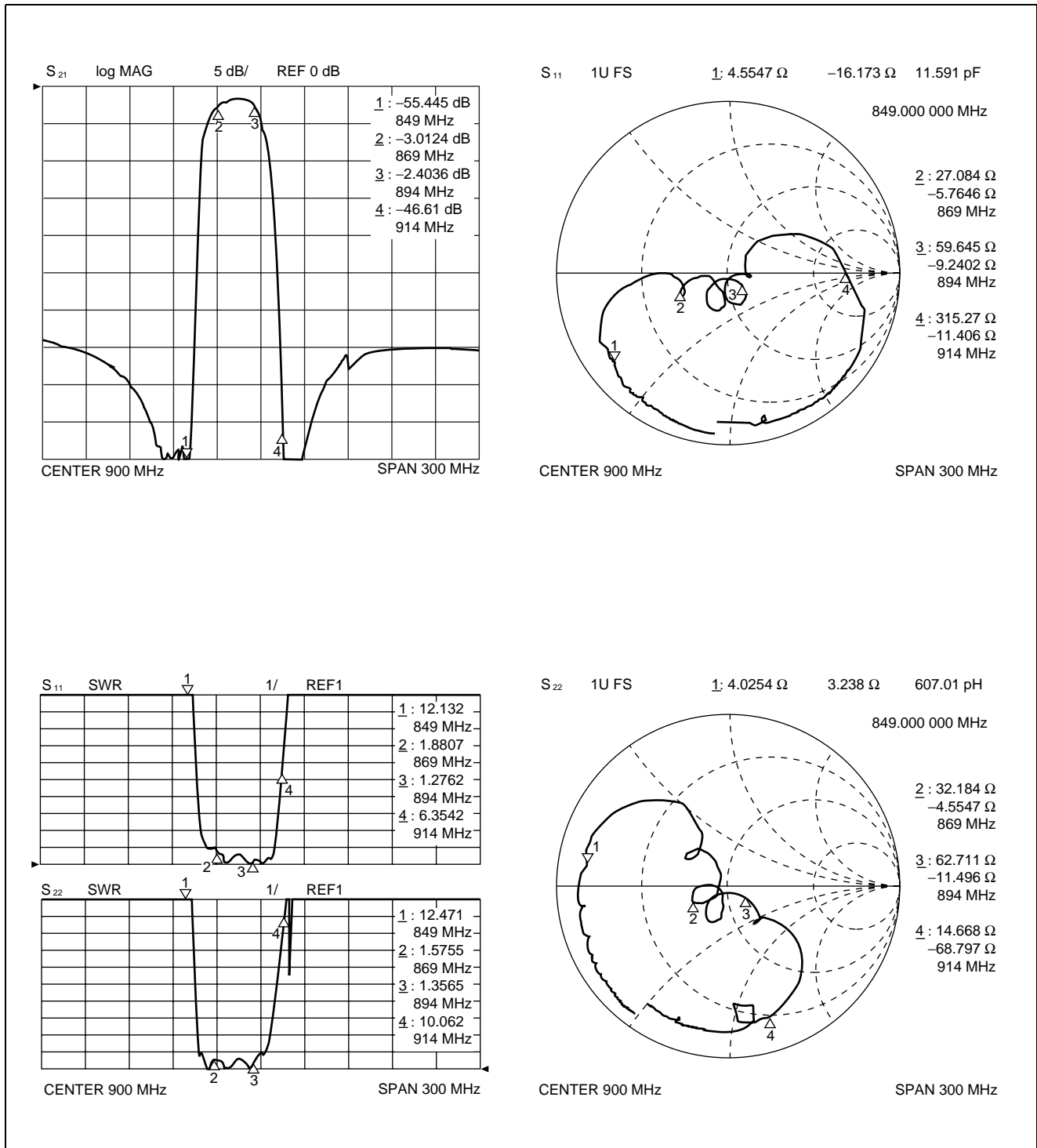

F5/F6 Series (K2 type)

5. GSM (Tx)

Part number: FAR-F5CE-902M50-K213

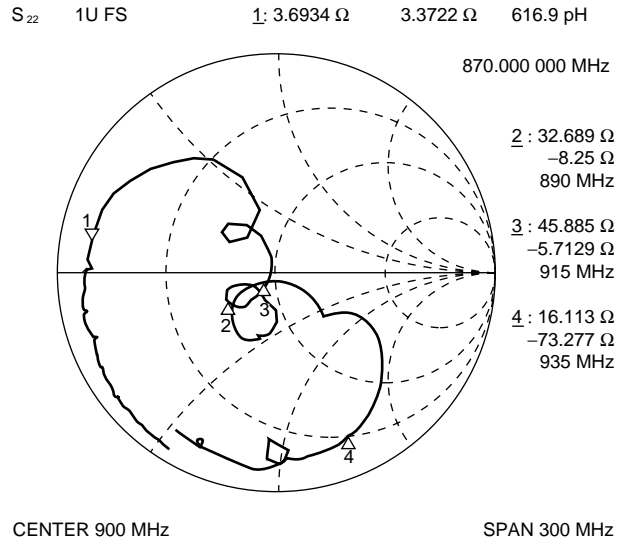
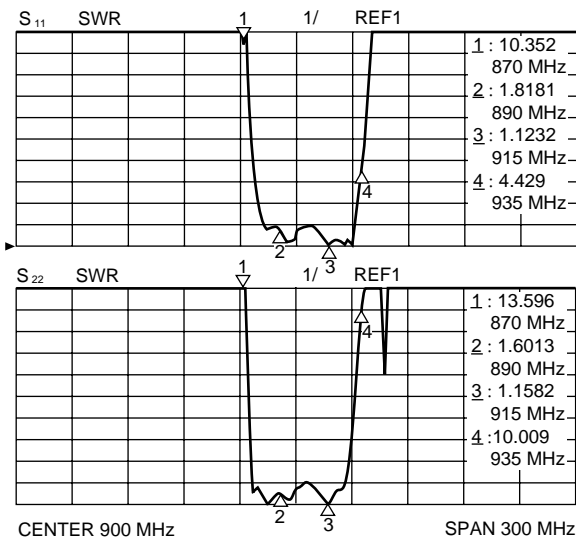
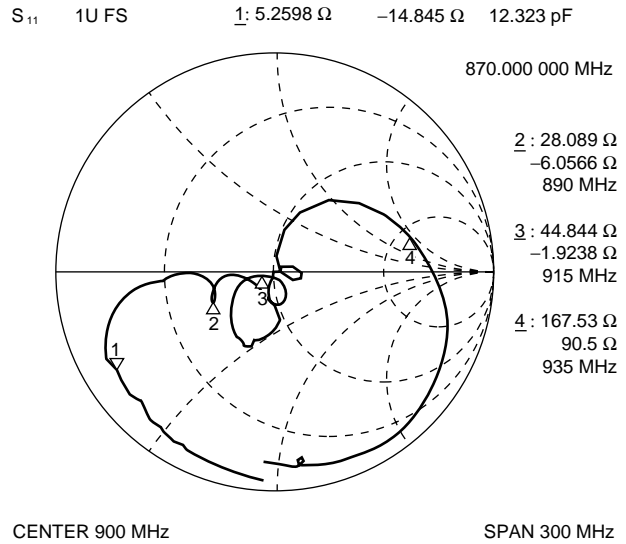
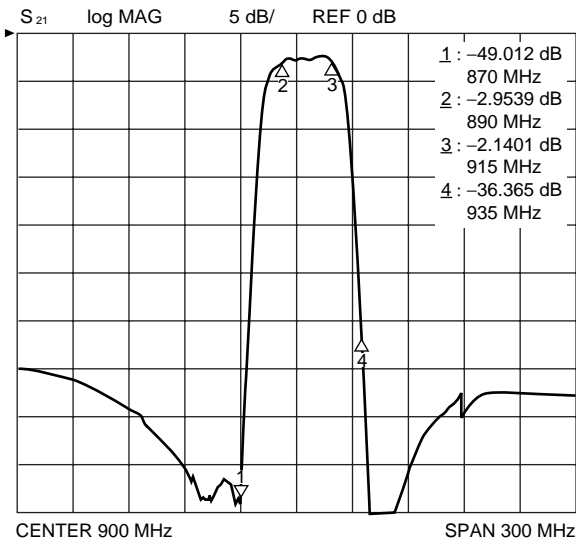

F5/F6 Series (K2 type)

6. GSM (Rx) Ultra Low Loss type Part number: FAR-F5CE-947M50-K233

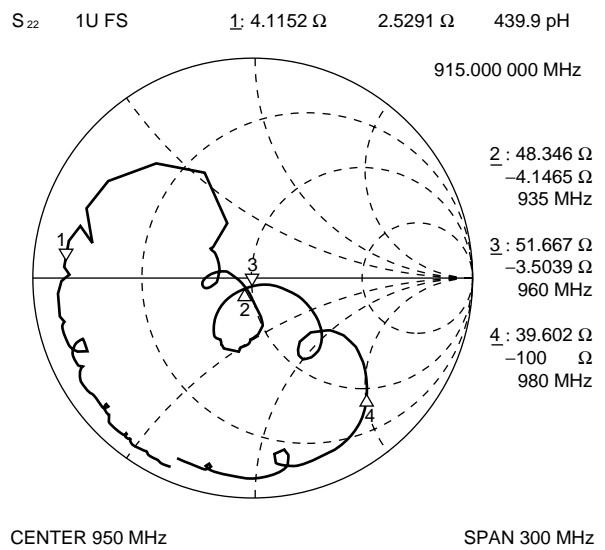
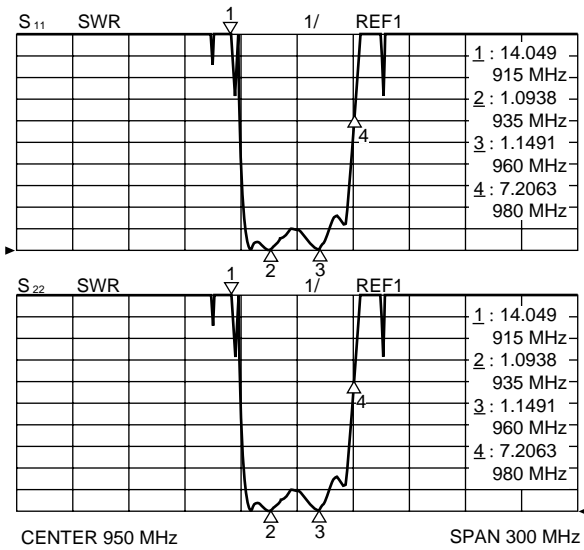
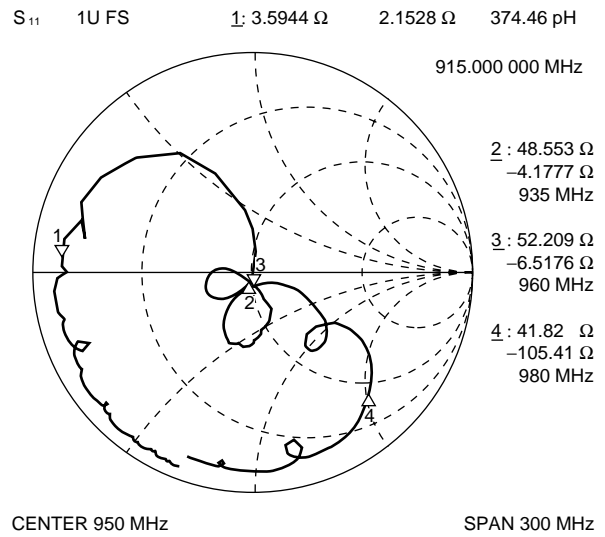
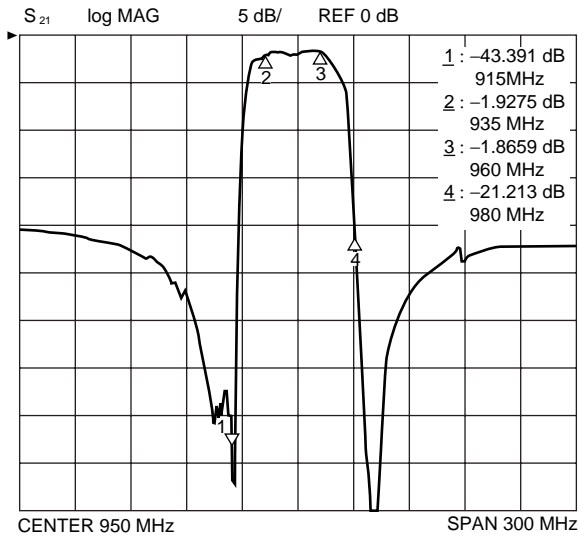

F5/F6 Series (K2 type)

7. GSM (Rx) Low Loss type

Part number: FAR-F5CE-947M50-K214

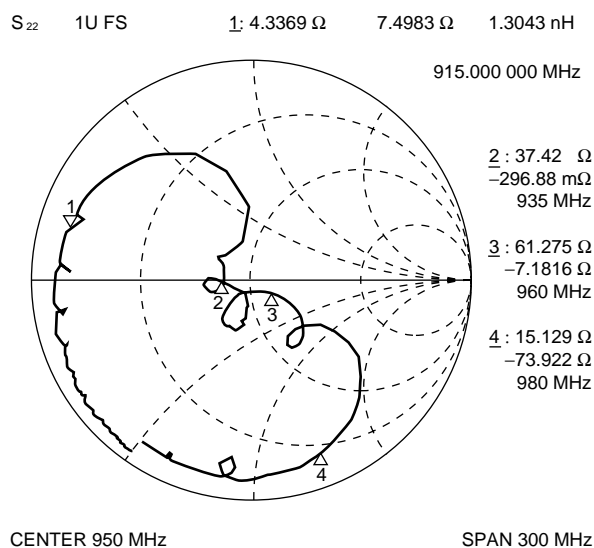
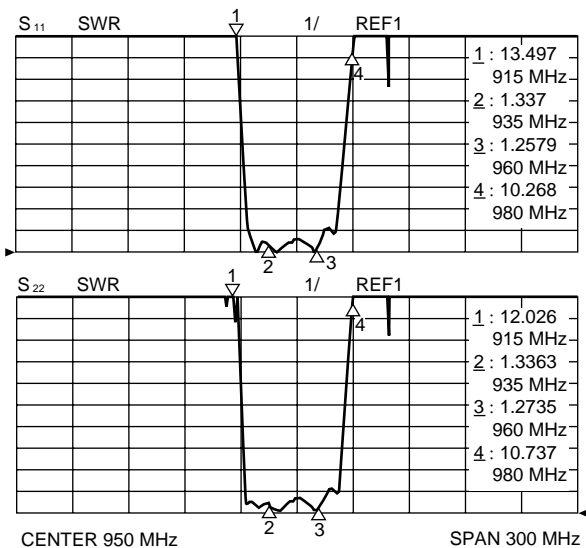
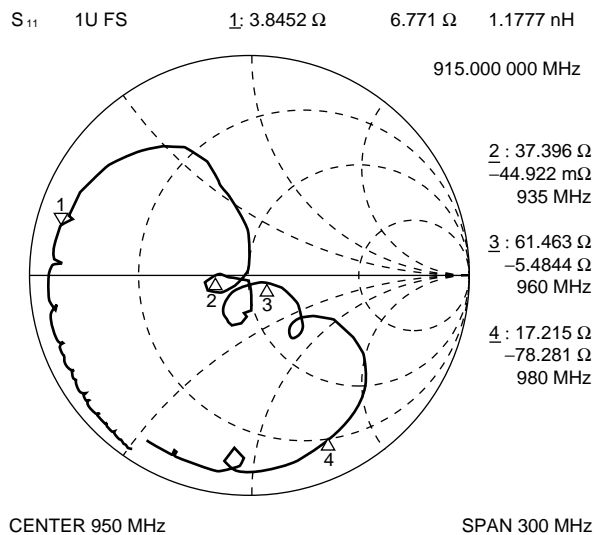
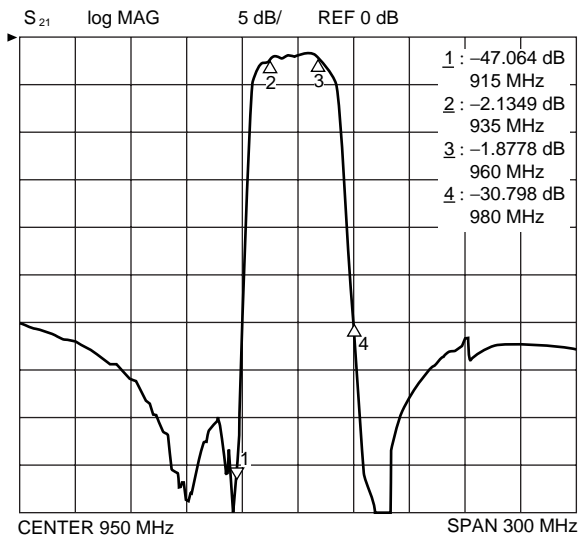

F5/F6 Series (K2 type)

8. GSM (Rx) High Attenuation type Part number: FAR-F5CE-947M50-K228

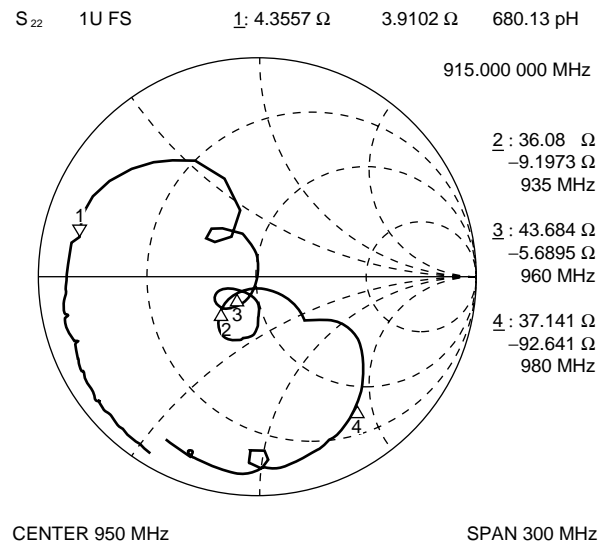
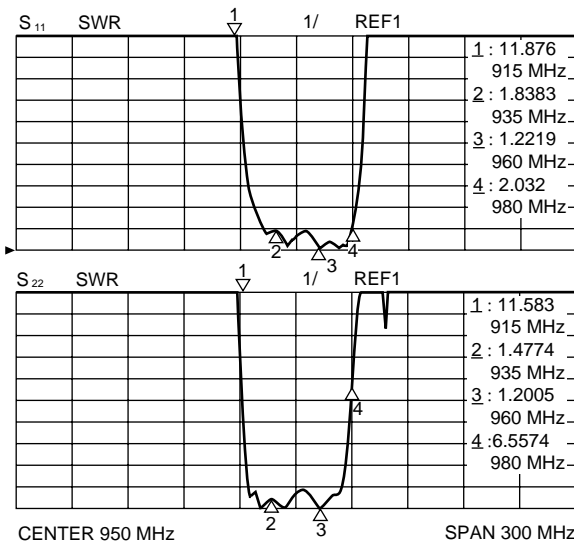
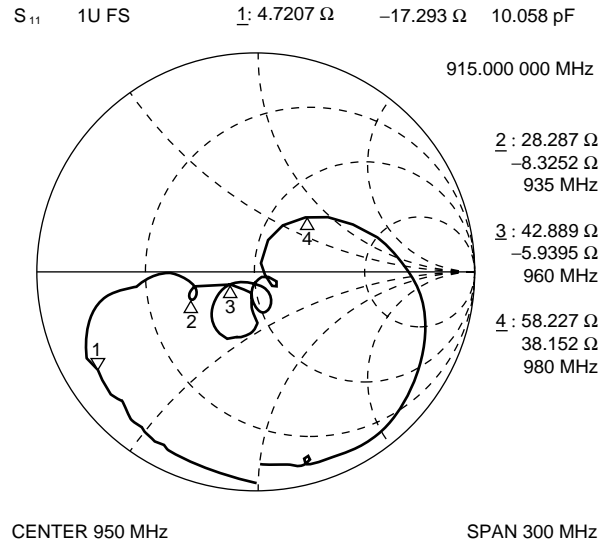
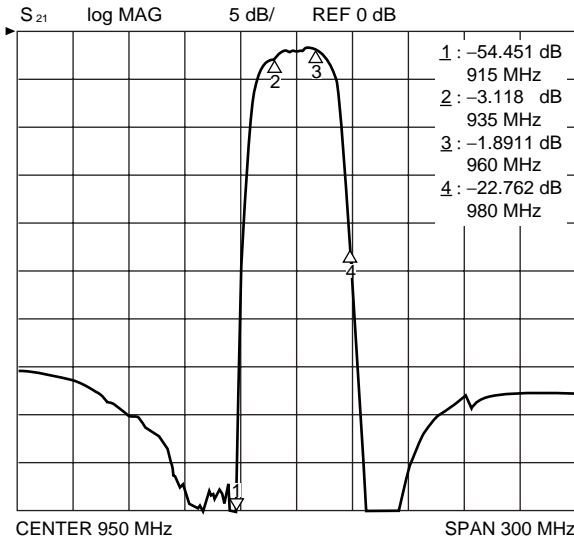

F5/F6 Series (K2 type)

9. EGSM (Tx)

Part number: FAR-F5CE-897M50-K226

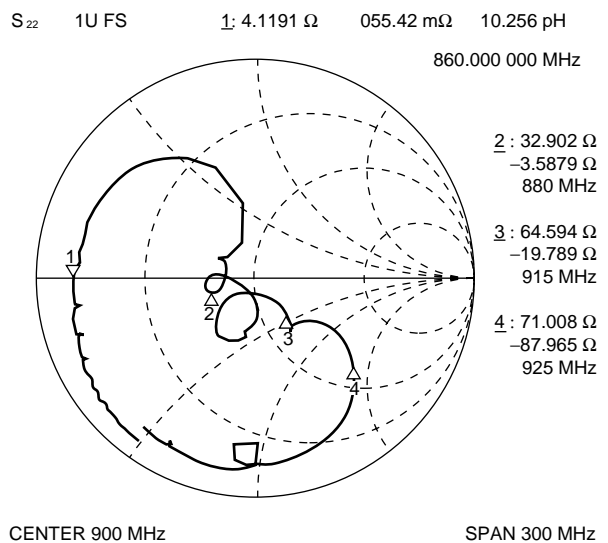
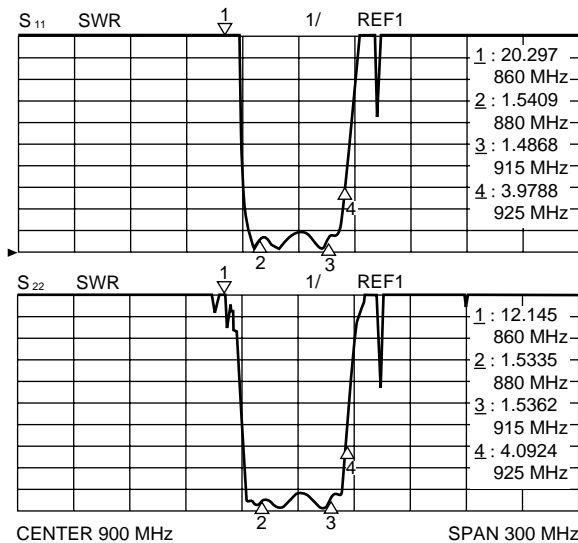
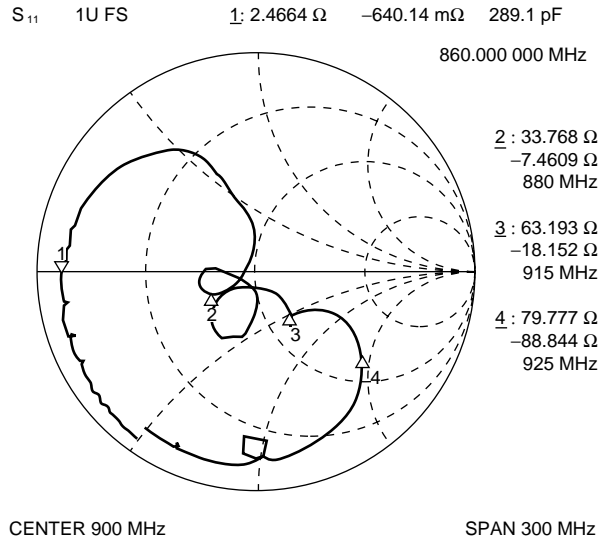
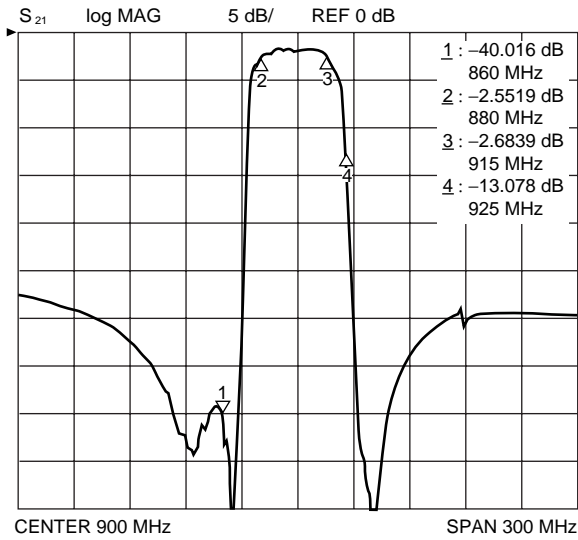

F5/F6 Series (K2 type)

10. EGSM (Rx) Low Loss type

Part number: FAR-F5CE-942M50-K288

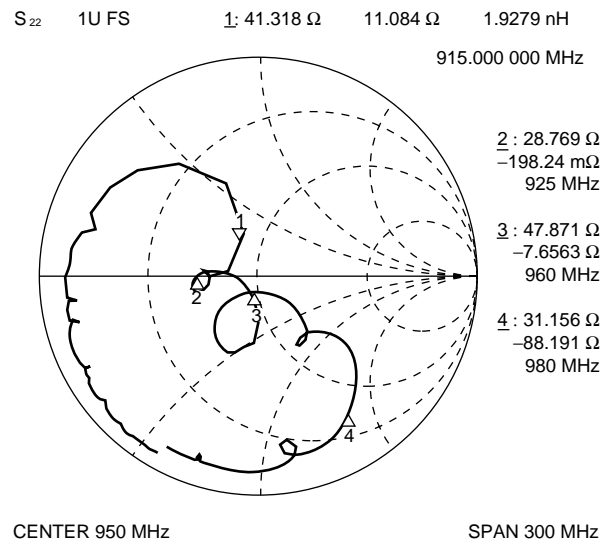
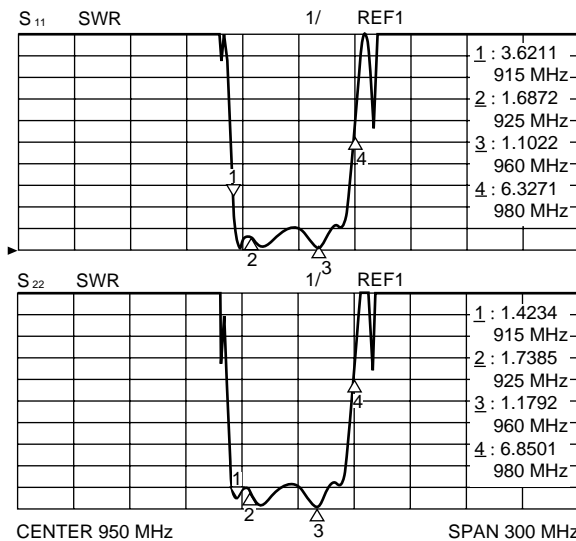
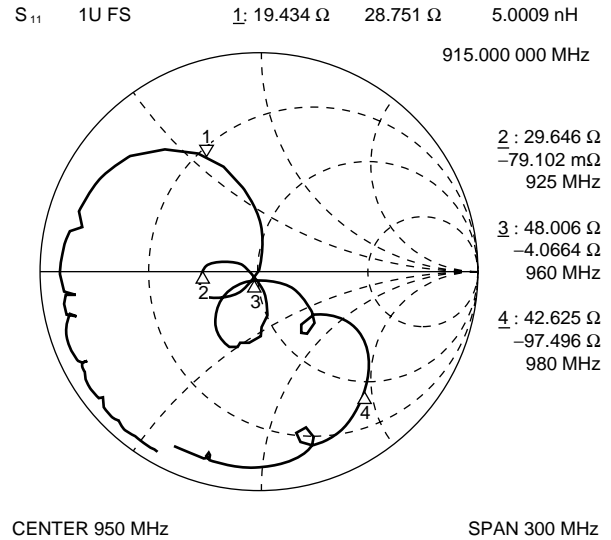
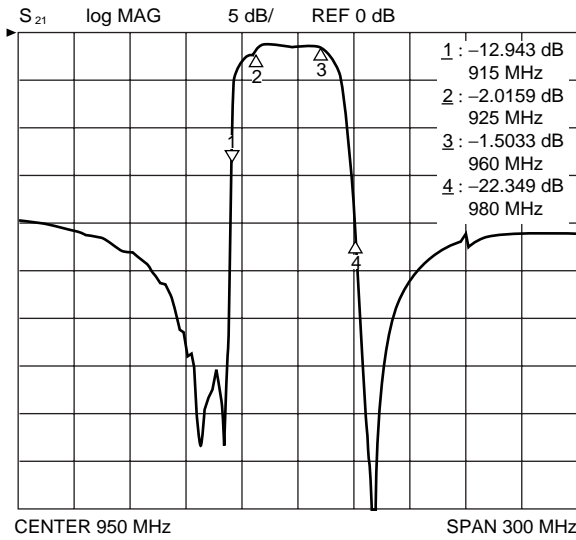

F5/F6 Series (K2 type)

11. EGSM (Rx)

Part number: FAR-F5CE-942M50-K216

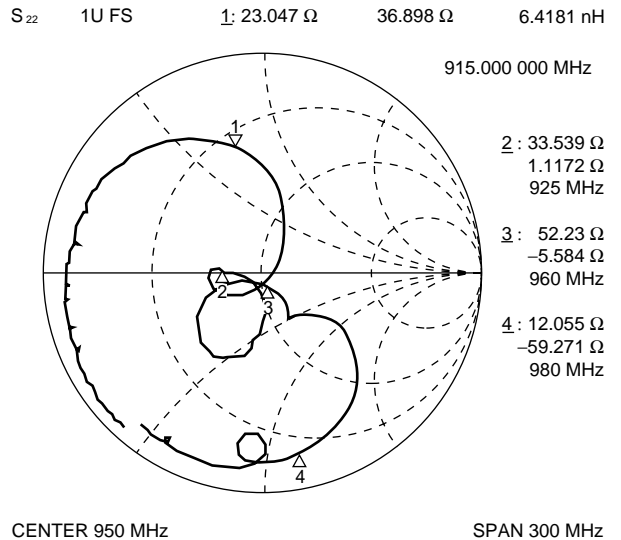
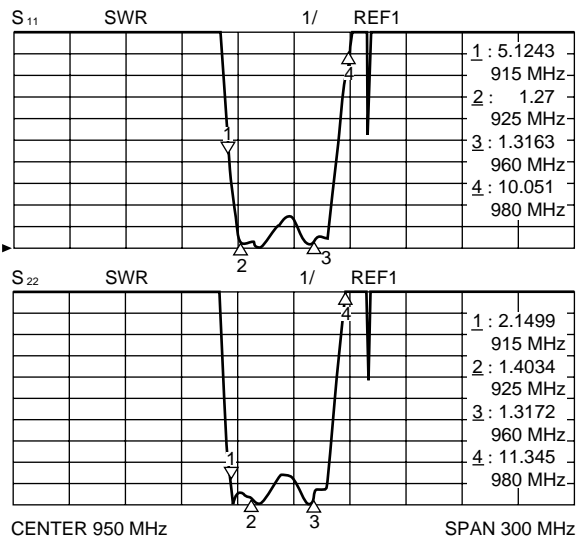
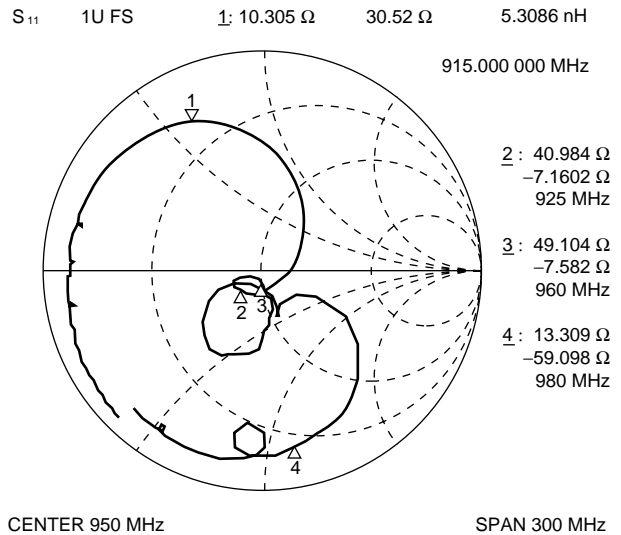
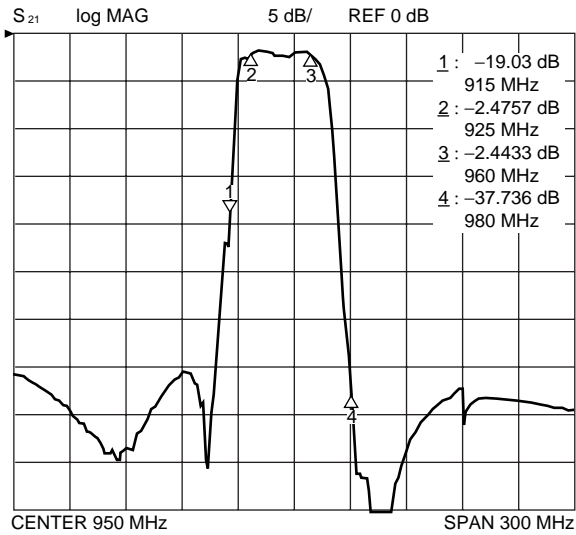

F5/F6 Series (K2 type)

12. PDC800 (Tx)

Part number: FAR-F5CE-950M00-K201

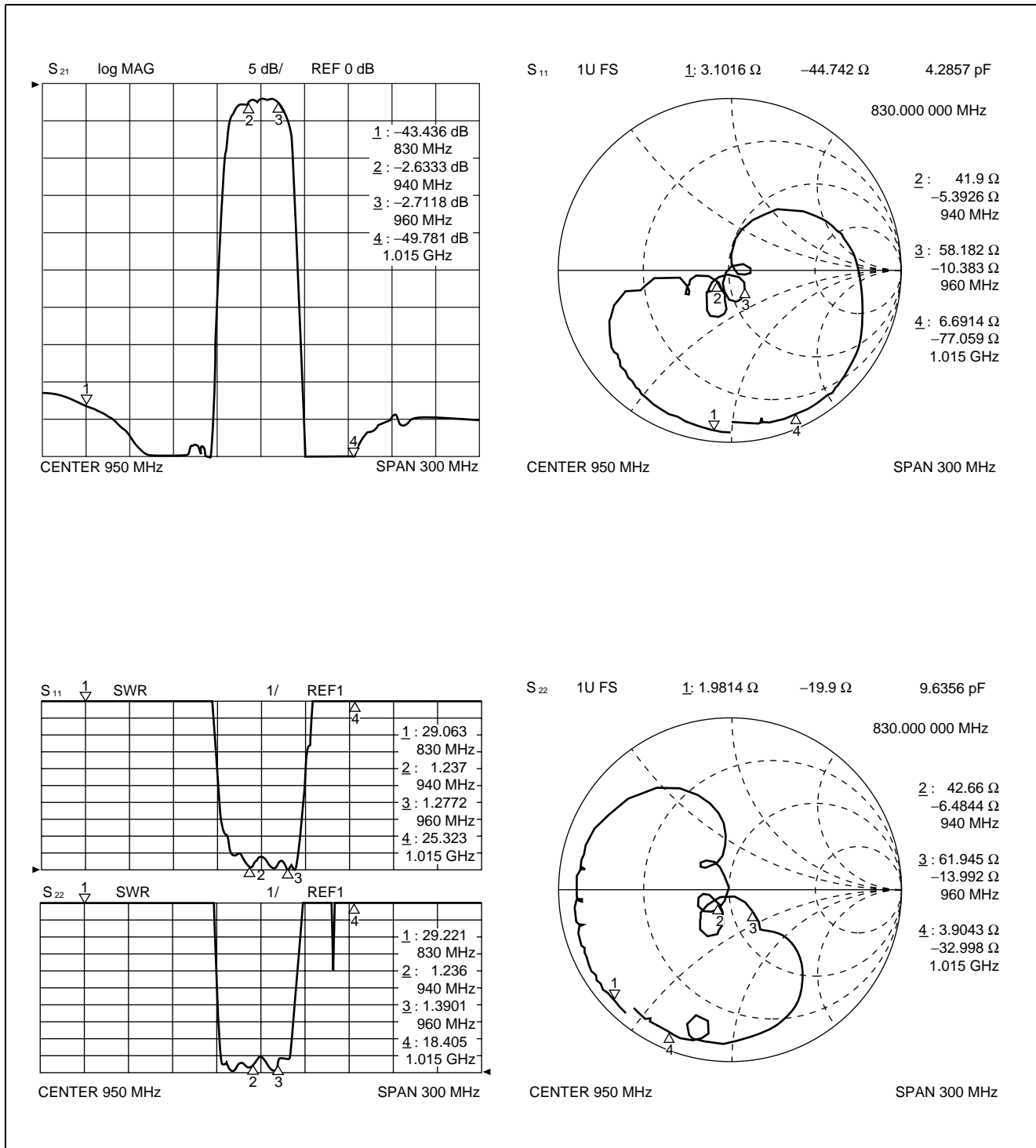

F5/F6 Series (K2 type)

13. PDC800 (Rx) Low Loss type

Part number: FAR-F5CE-820M00-K202

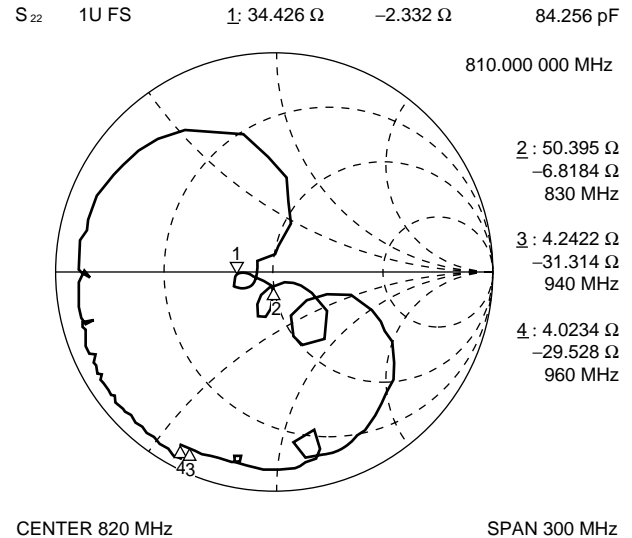
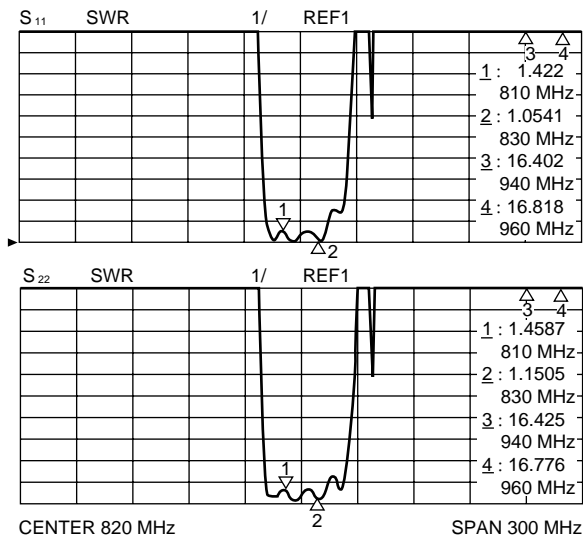
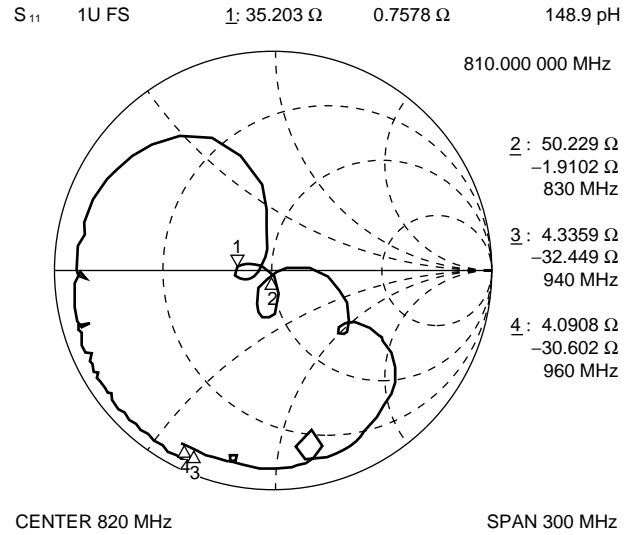
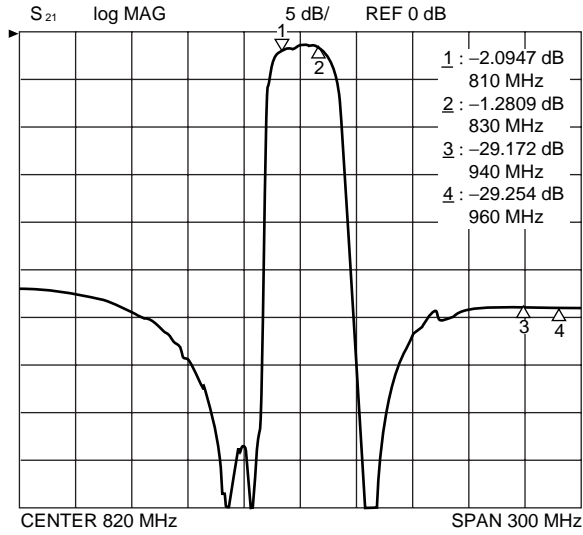

F5/F6 Series (K2 type)

14. PDC800 (Rx) High Attenuation type

Part number: FAR-F5CE-820M00-K204

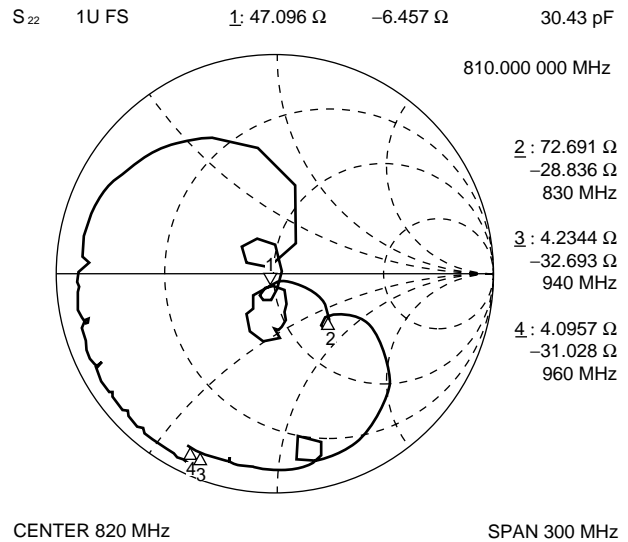
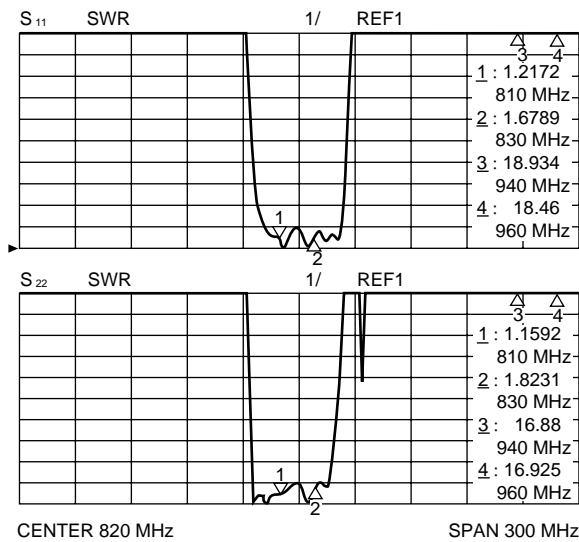
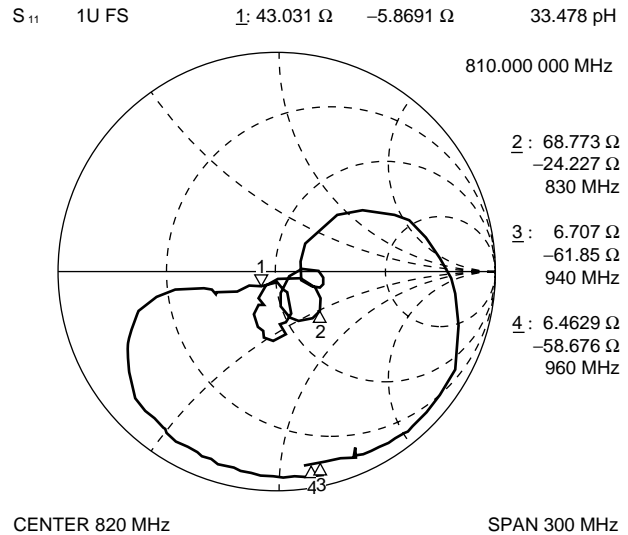
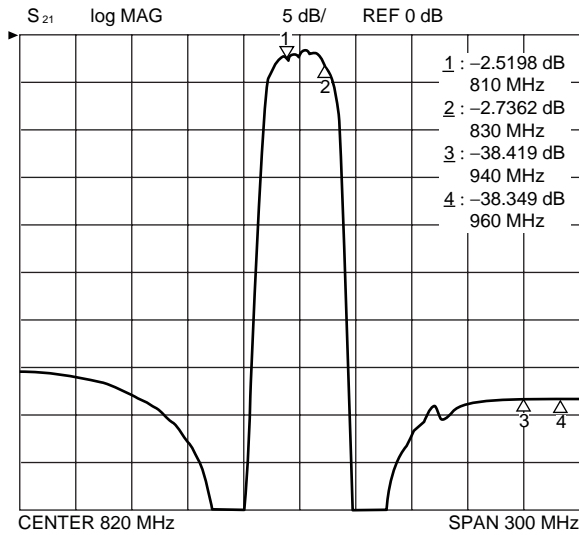

F5/F6 Series (K2 type)

15. cdmaOne (Tx) Low Loss type
Part number: FAR-F5CE-906M00-K211

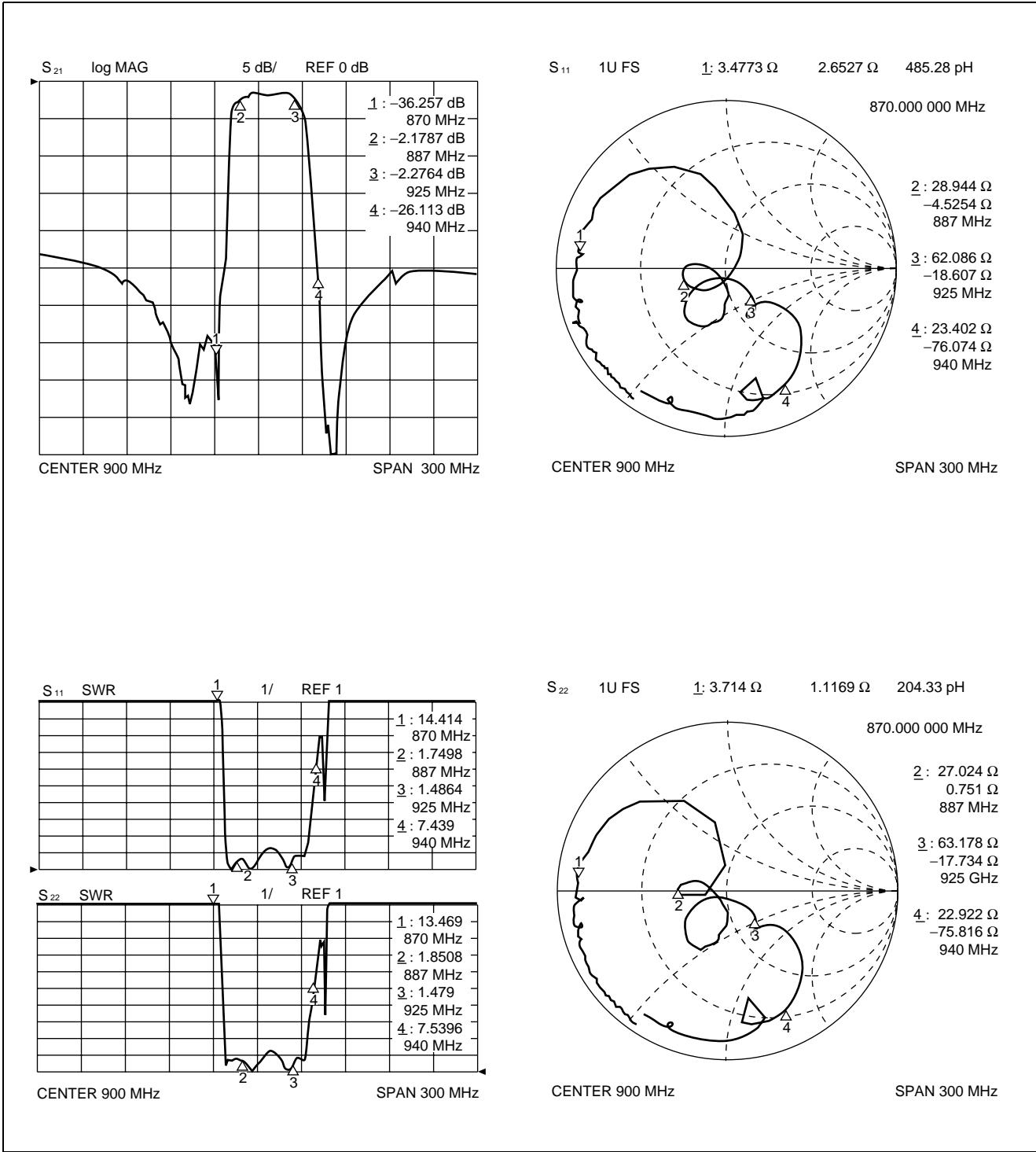

F5/F6 Series (K2 type)

16. cdmaOne (Tx)

Part number: FAR-F5CE-906M00-K219

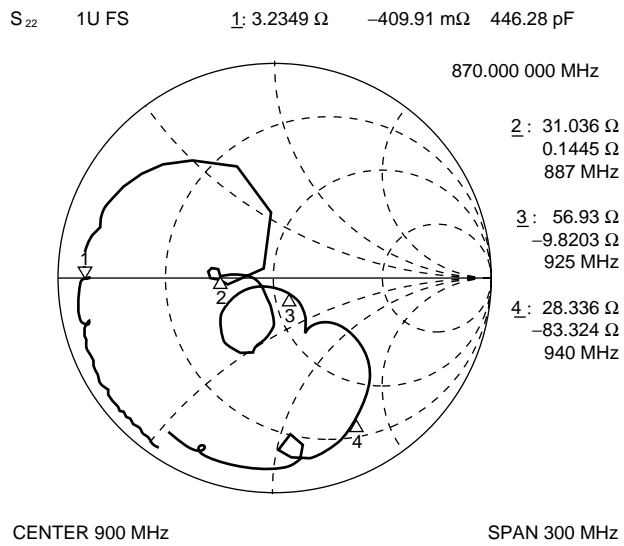
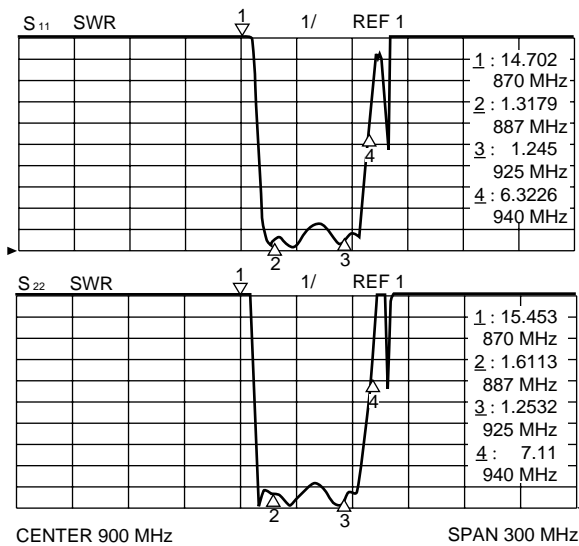
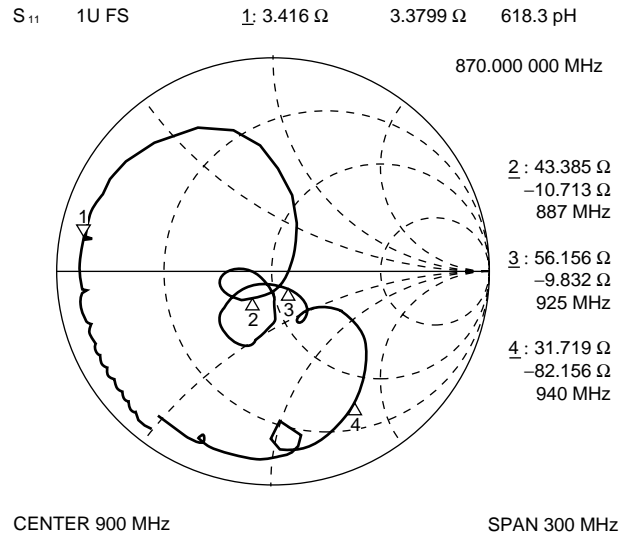
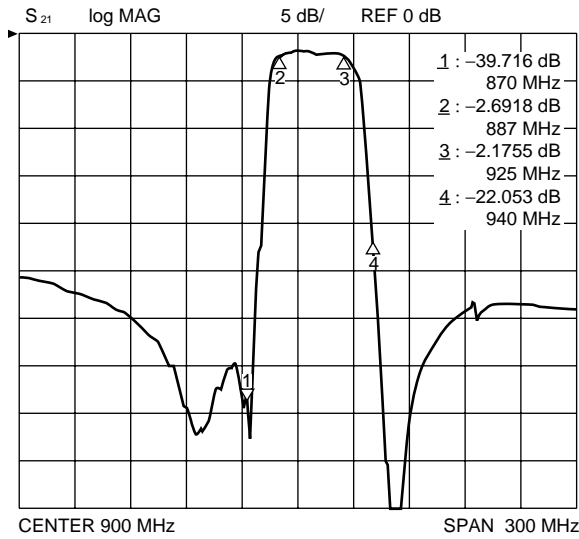

F5/F6 Series (K2 type)

17. cdmaOne (Tx) High Attenuation type Part number: FAR-F5CE-906M00-K215

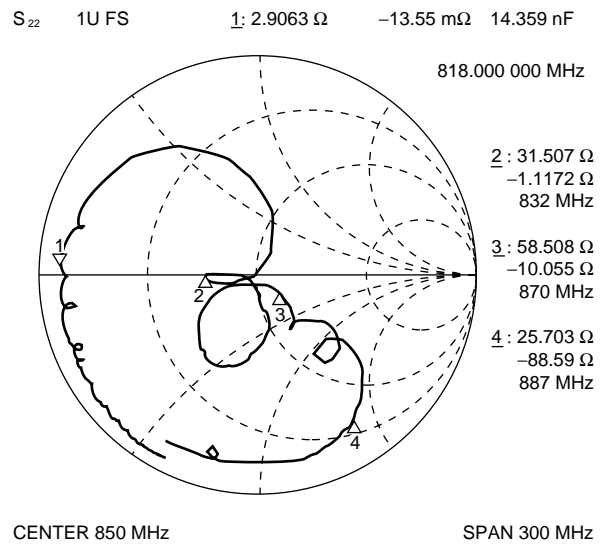
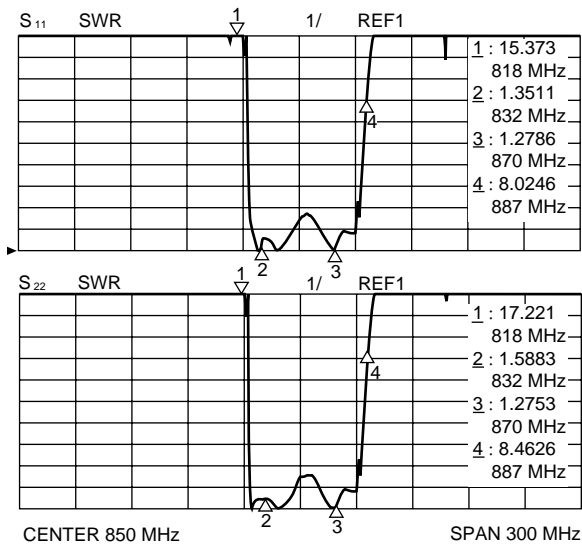
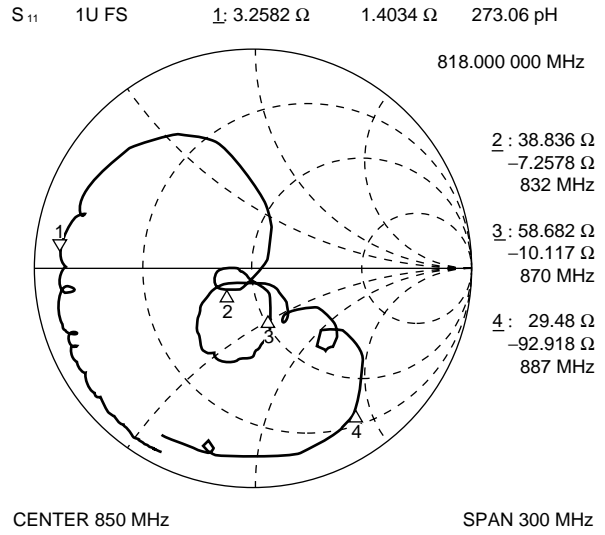
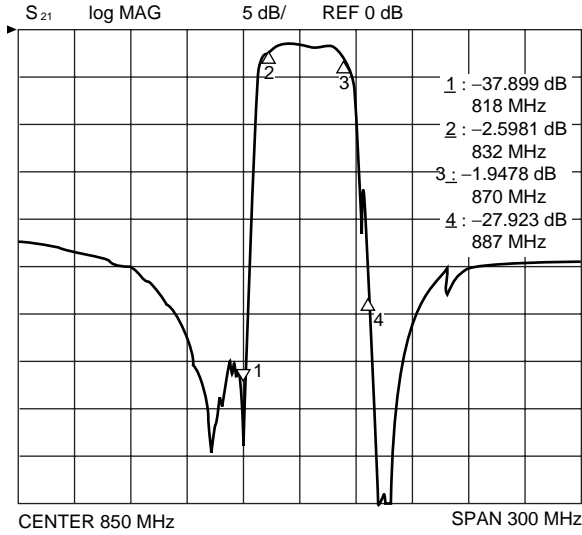

F5/F6 Series (K2 type)

18. cdmaOne (Rx)

Part number: FAR-F5CE-851M00-K212

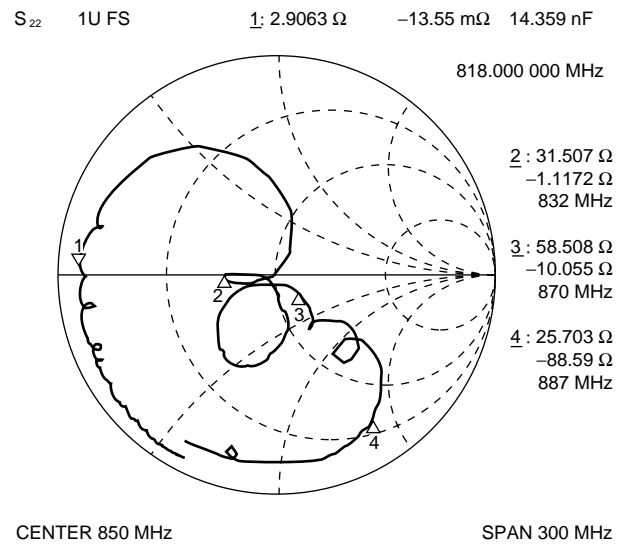
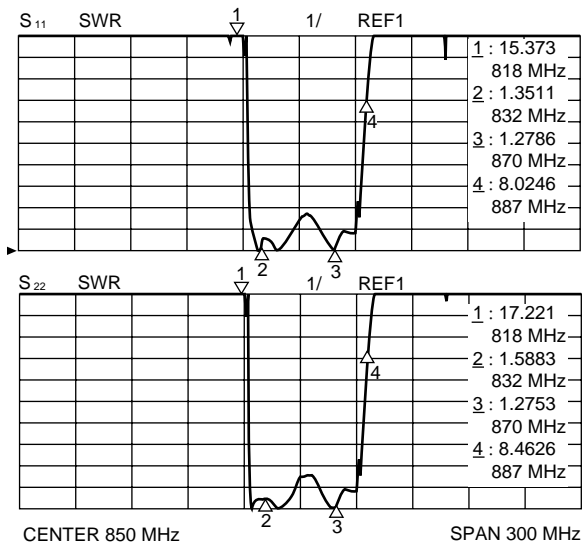
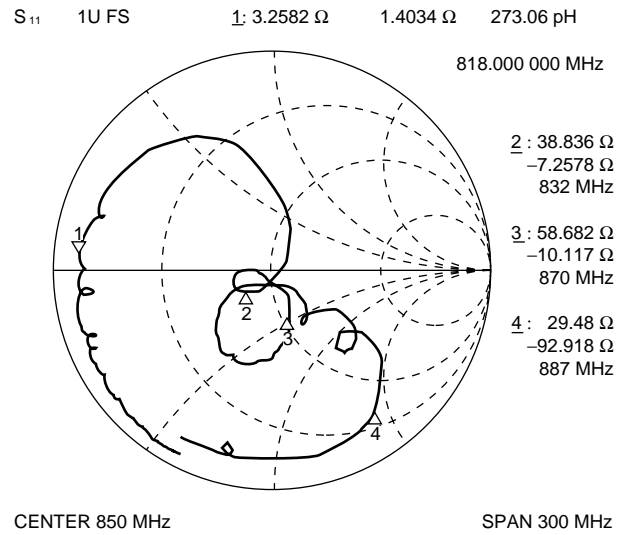
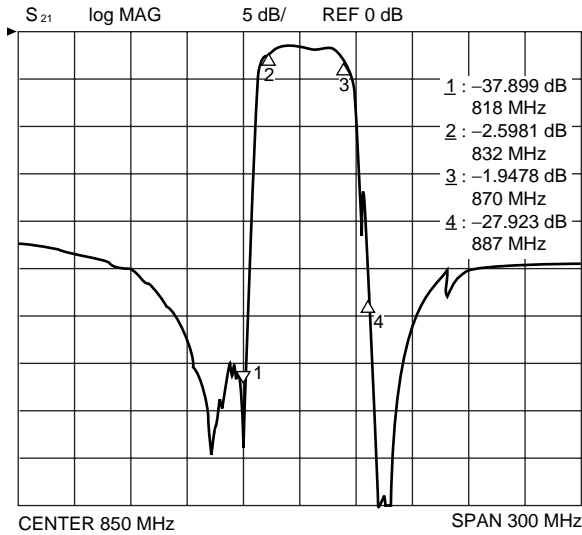

F5/F6 Series (K2 type)

19. PDC1.5 G (Tx) Low Loss type

Part number: FAR-F6CE-1G4410-K223

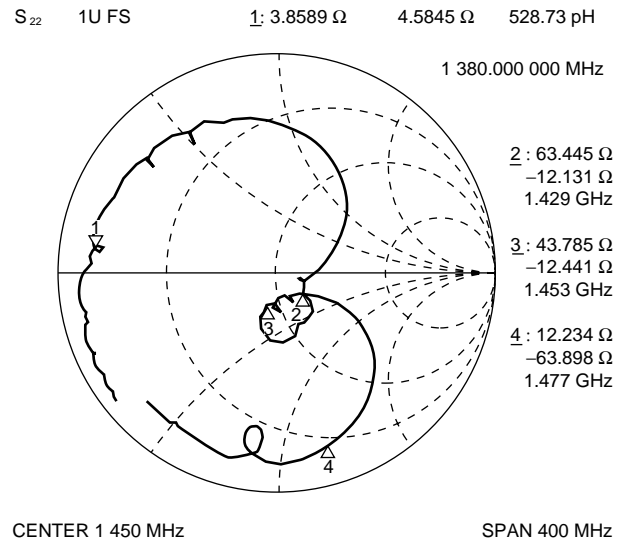
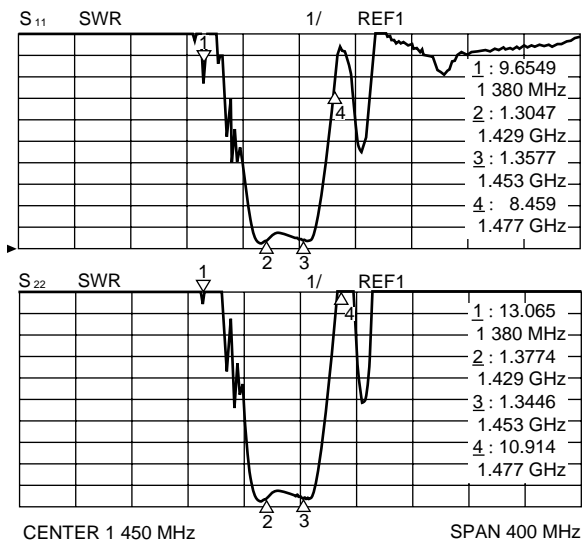
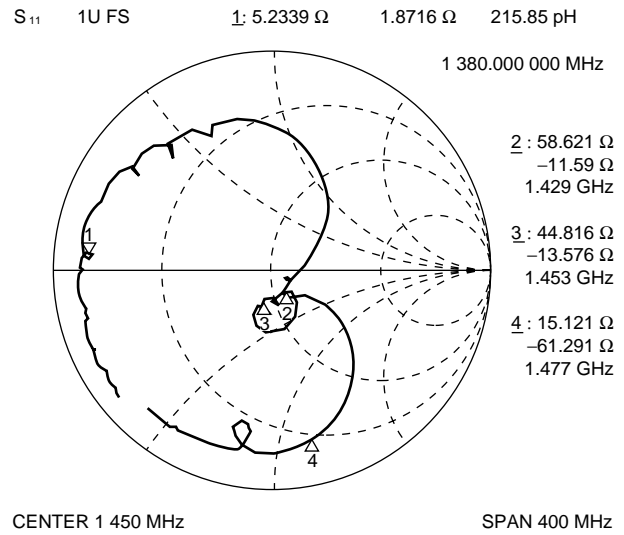
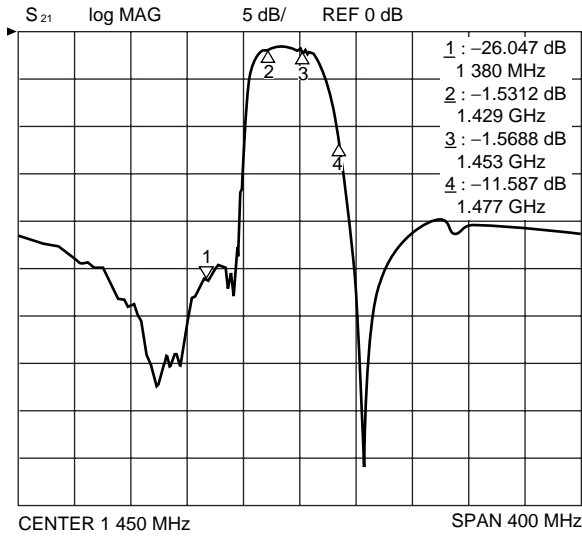

F5/F6 Series (K2 type)

20. PDC1.5 G (Tx) High Attenuation type Part number: FAR-F6CE-1G4410-K220

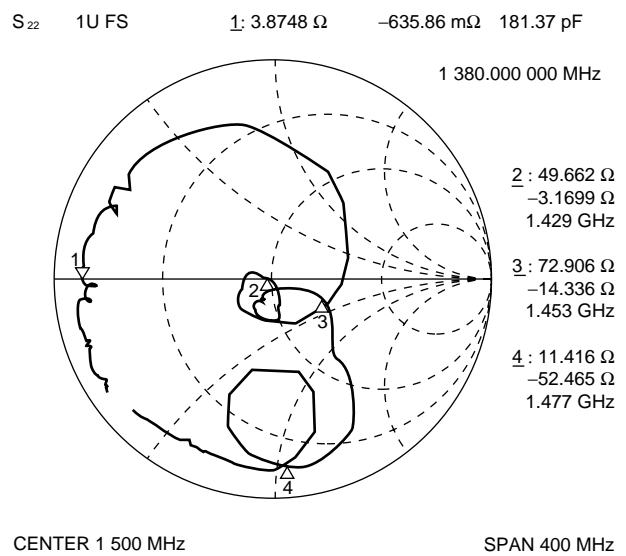
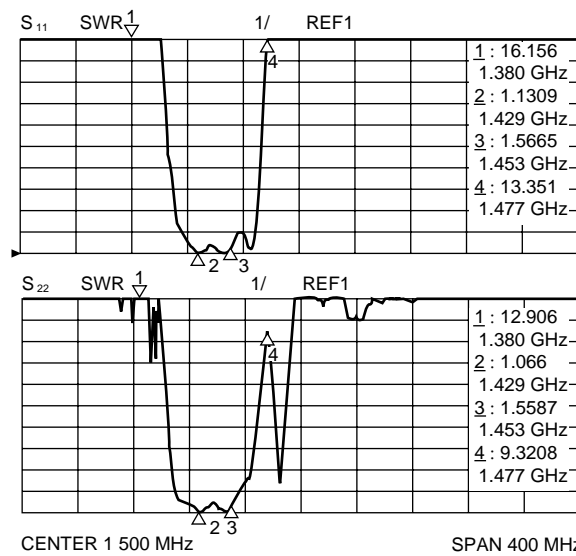
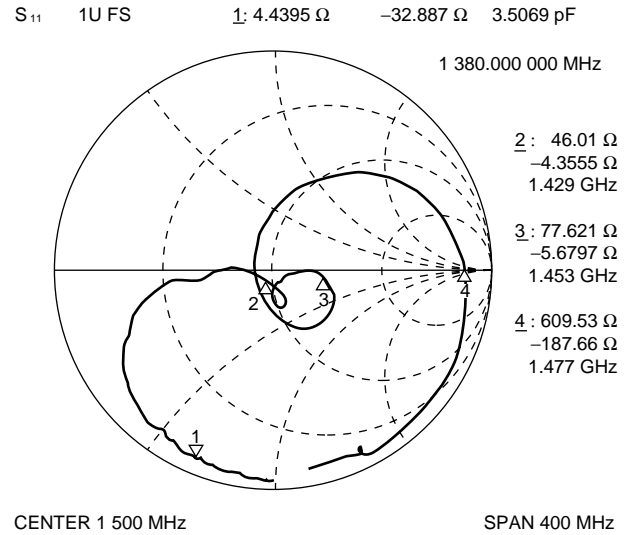
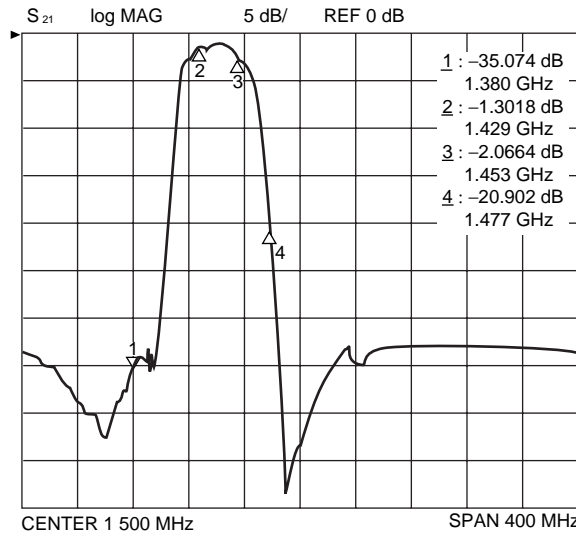

F5/F6 Series (K2 type)

21. PDC1.5 G (Rx) Low Loss type

Part number: FAR-F6CE-1G4890-K224

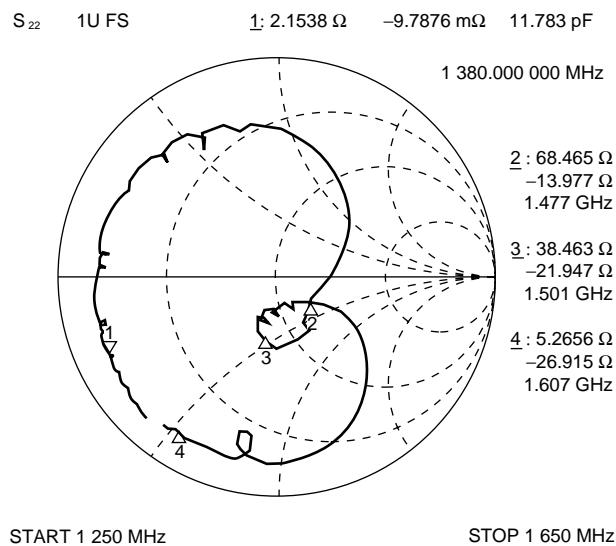
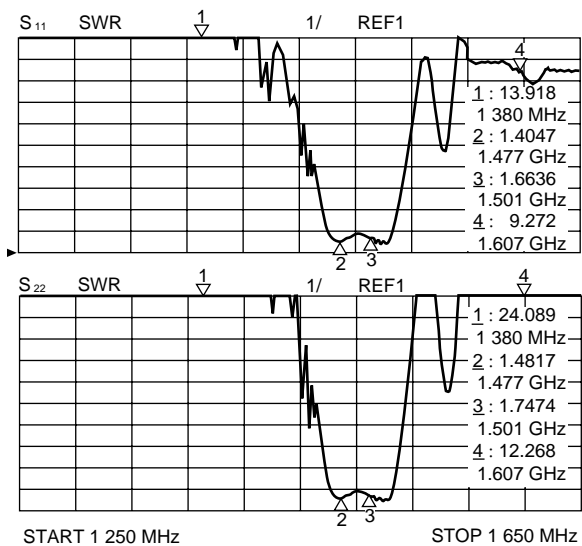
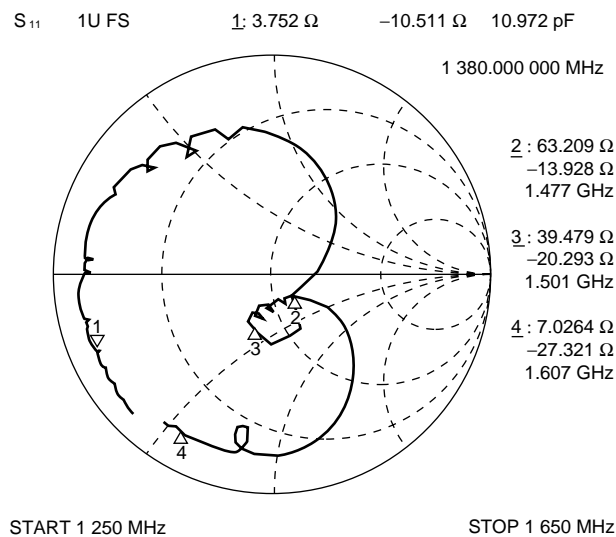
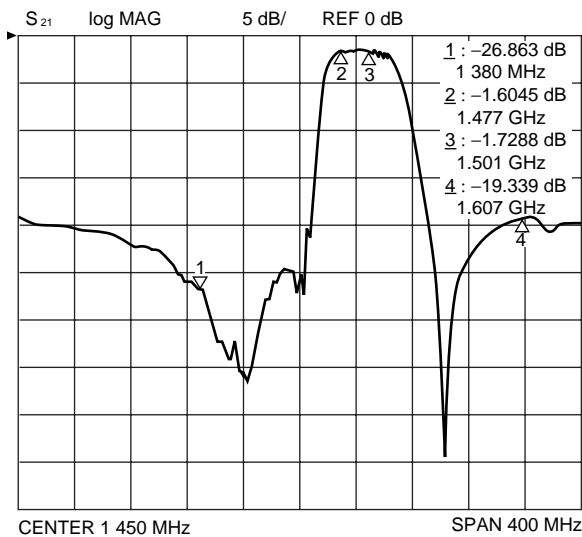

F5/F6 Series (K2 type)

22. PDC1.5 G (Rx) High Attenuation type Part number: FAR-F6CE-1G4890-K221

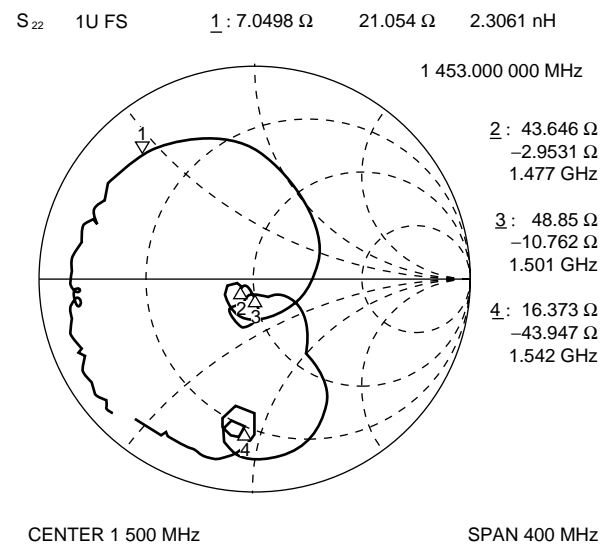
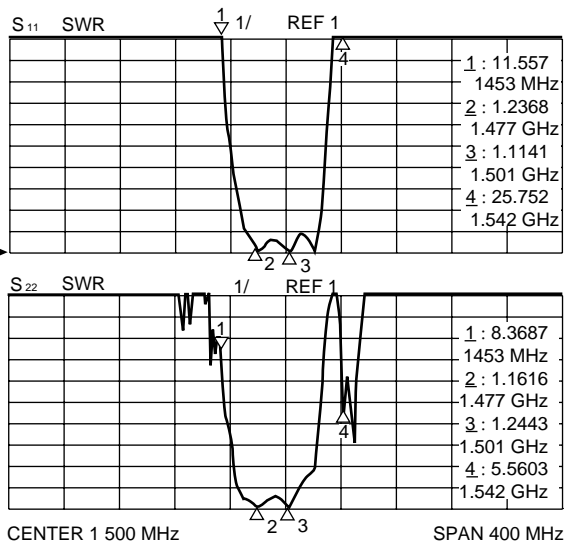
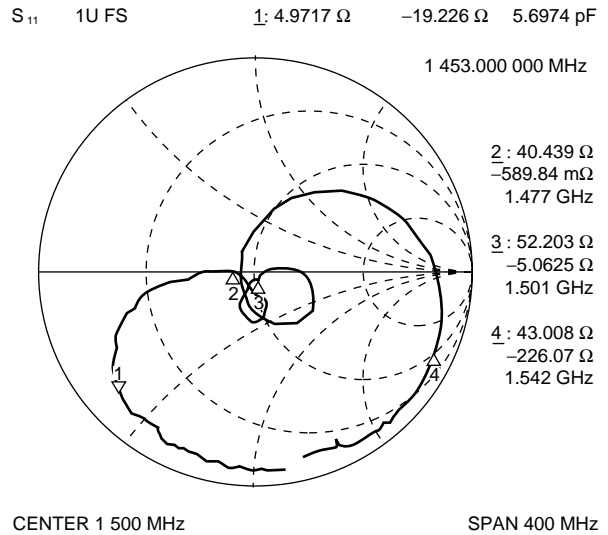
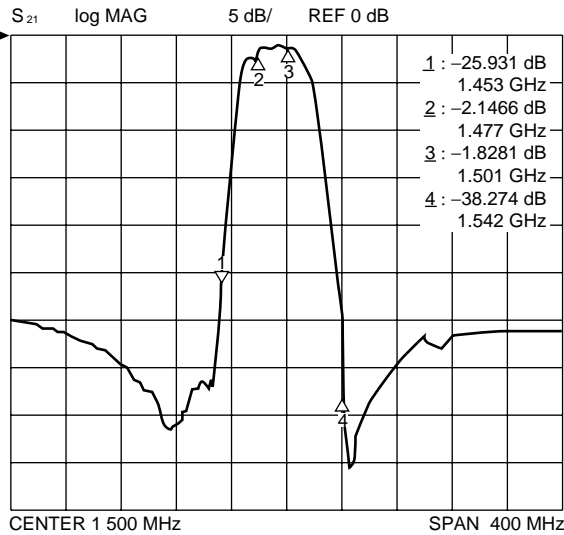

F5/F6 Series (K2 type)

MEASUREMENT CIRCUIT

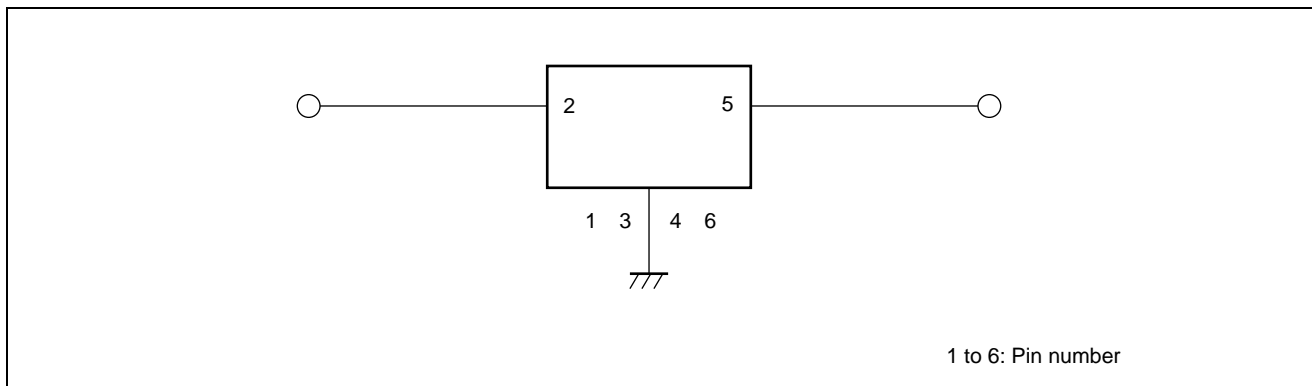

PART NUMBER DESIGNATION

[Designation example]

FAR-F□CE-□□□□□□-K2□□-□
 (1) (2) (3) (4) (5)

- (1) Frequency range : 5: 700 to 1000 MHz
6: 1000 to 1700 MHz
- (2) Package size : E:3.0mm[□] × 1.2mm
- (3) Frequency : This specifies the nominal center frequency using six alphanumeric.
M (for MHz) or G (for GHz) indicates the decimal point.
[Example]906.0 MHz ⇒ 906M00
1.441GHz ⇒ 1G4410
- (4) Part symbol : Numbers specified by Fujitsu
Refer to STANDARD FREQUENCIES.
- (5) Packing (Reeled tape) : W : 1 k pcs/reel
V : 3 k pcs/reel
U : 5 k pcs/reel

MARKING

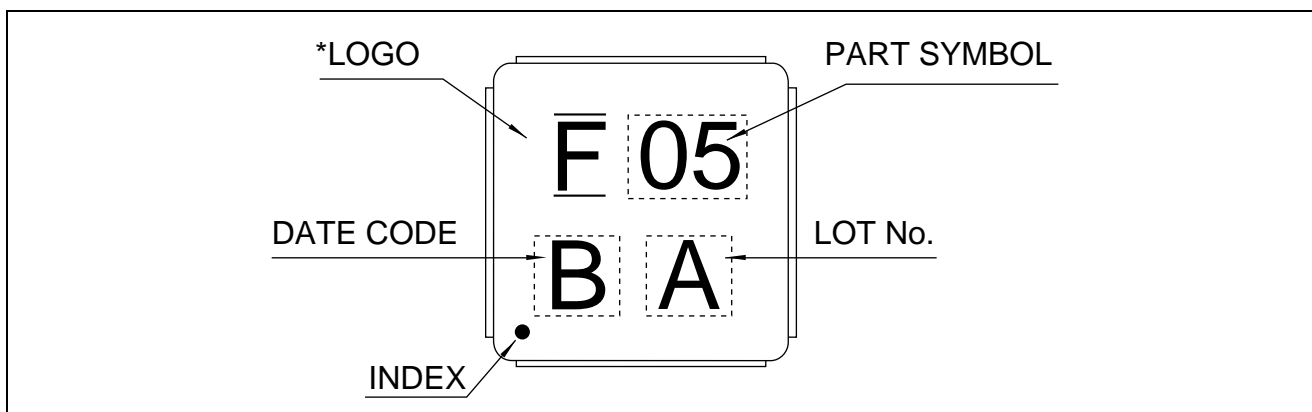

*For following parts, "K" is marked in place of "F".

FAR-F5CE-836M50-K230
 FAR-F5CE-947M50-K233

F5/F6 Series (K2 type)

■ PACKAGE DIMENSION

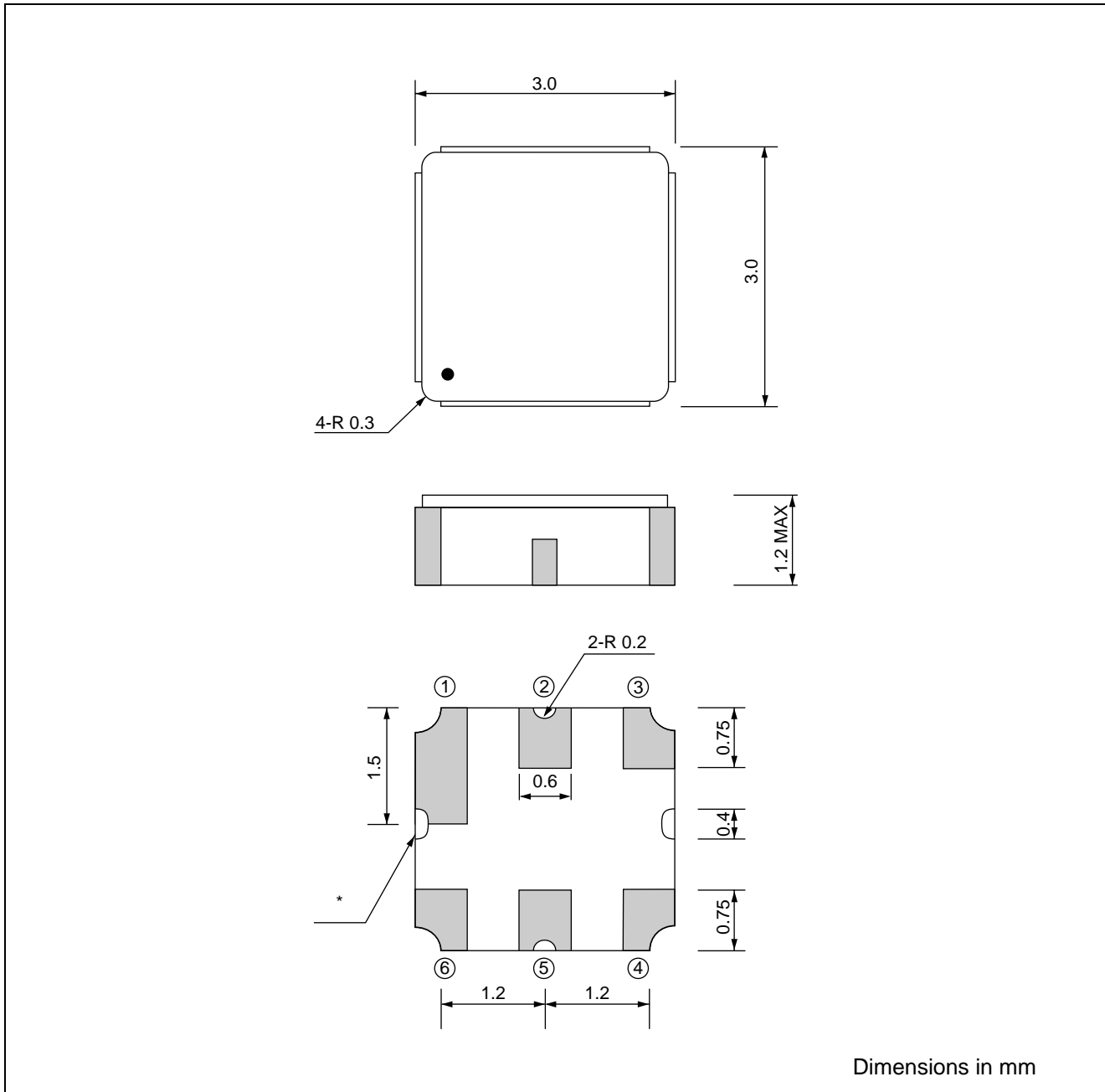

*Two types of package are available.
One of them may be supplied without these cut outs.

F5/F6 Series (K2 type)

■ PACKING: Reel type

1. Reel Dimensions

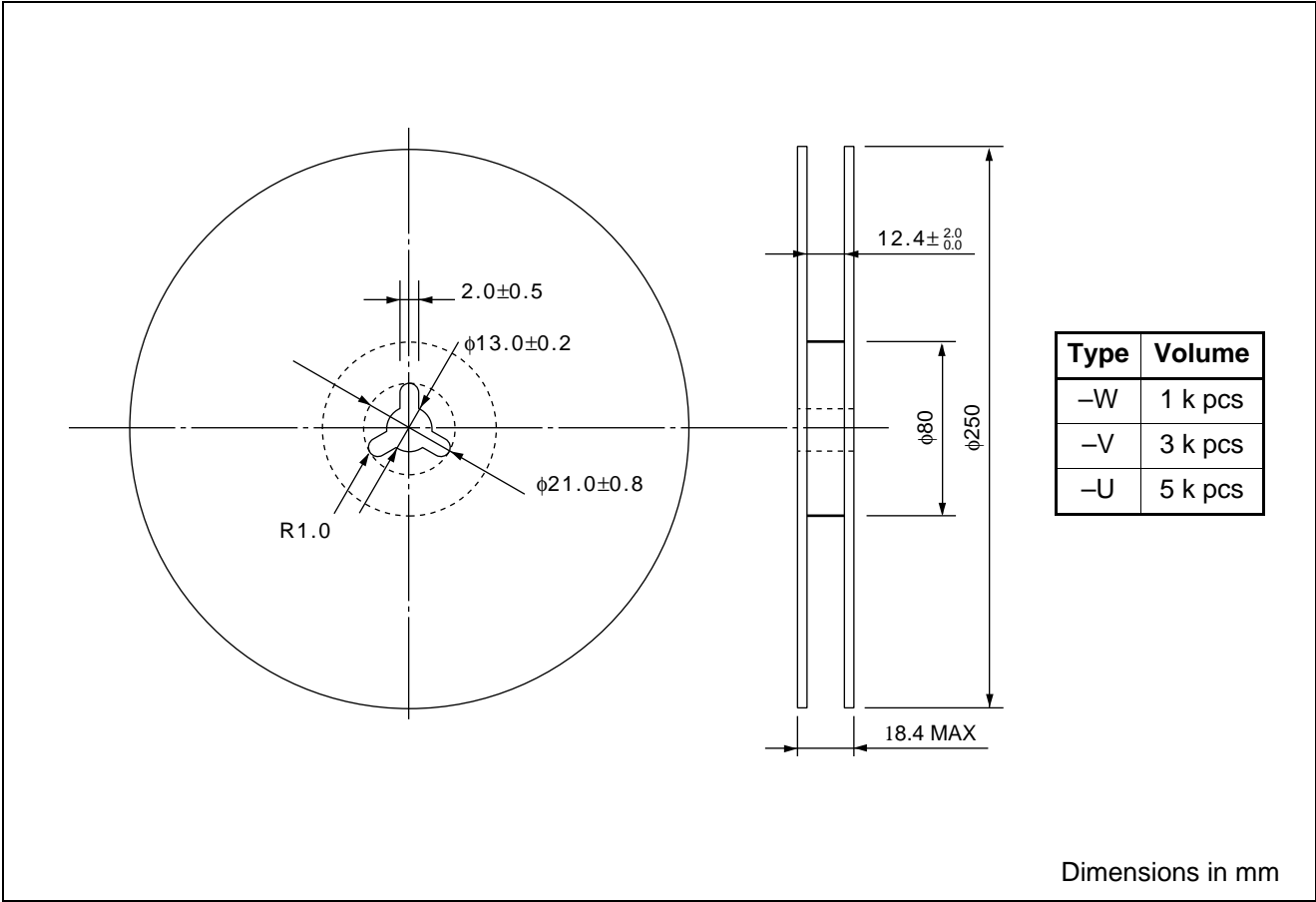

2. Packing Style

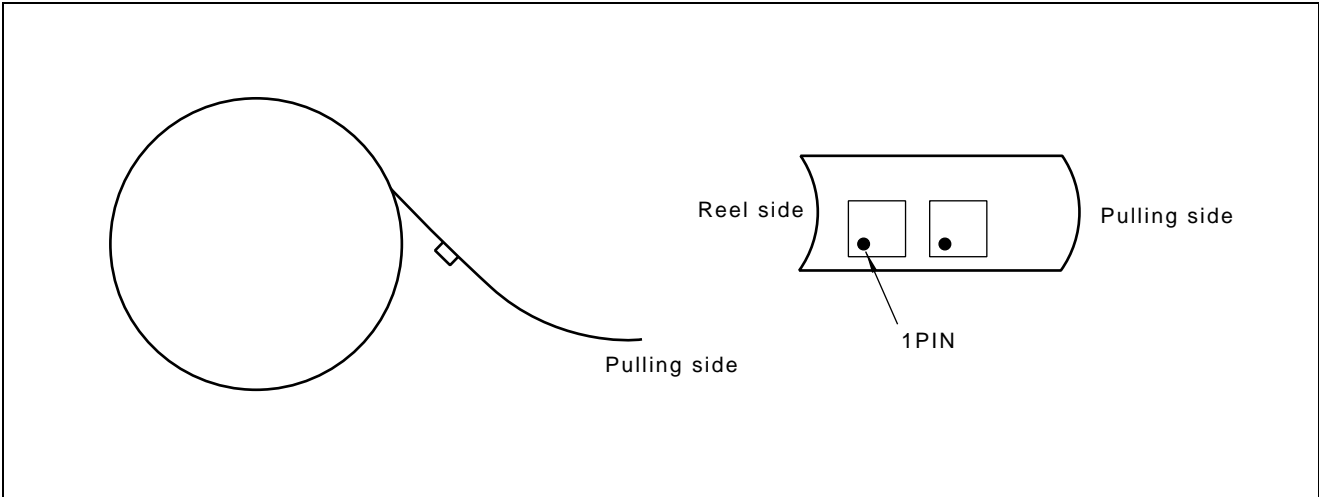

F5/F6 Series (K2 type)

3. Tape Dimensions

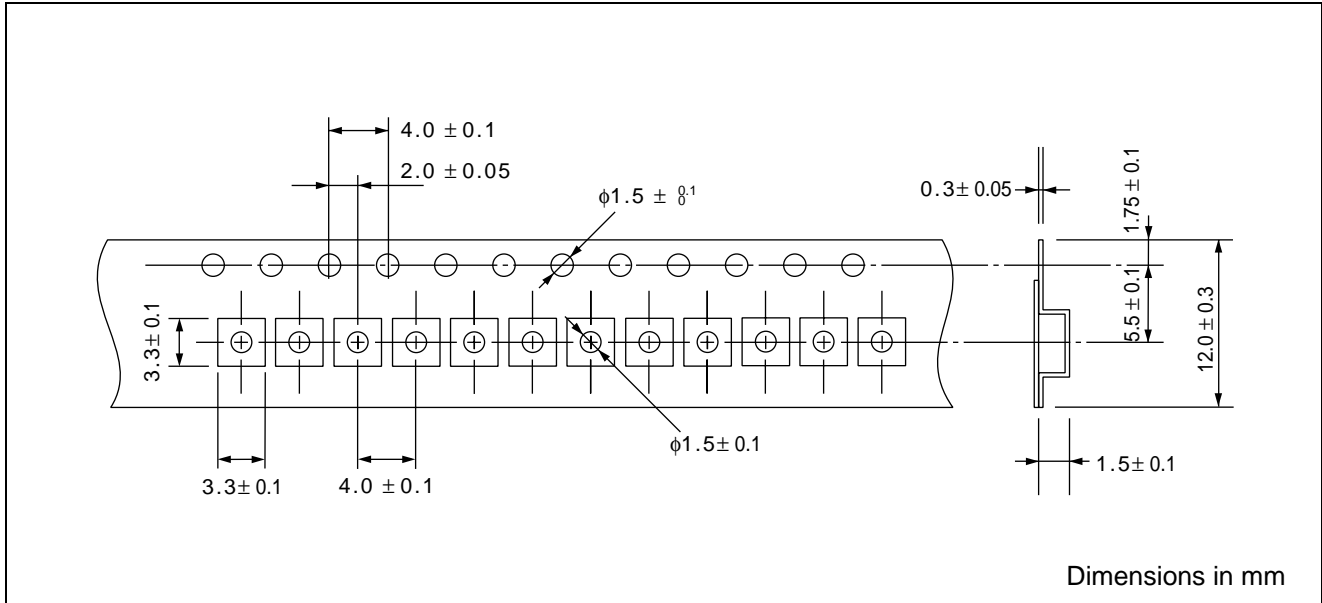

FUJITSU LIMITED

For further information please contact:

Japan

FUJITSU MEDIA DEVICES LIMITED
Marketing and Technical Support Dept.
SUN HAMADA BLDG 2F
1-19-20, Shin-yokohama
Kouhoku-ku, Yokohama-shi
Kanagawa 222-0033, Japan
Tel: 81(45) 471-0061
Fax: 81(45) 471-0076

North and South America

FUJITSU MICROELECTRONICS, INC.
Semiconductor Division
3545 North First Street
San Jose, CA 95134-1804, USA
Tel: (408) 922-9000
Fax: (408) 922-9179

Customer Response Center
Mon. - Fri.: 7 am - 5 pm (PST)
Tel: (800) 866-8608
Fax: (408) 922-9179

<http://www.fujitsumicro.com/>

Europe

FUJITSU MIKROELEKTRONIK GmbH
Am Siebenstein 6-10
D-63303 Dreieich-Buchsschlag
Germany
Tel: (06103) 690-0
Fax: (06103) 690-122

<http://www.fujitsu-edc.com/>

Asia Pacific

FUJITSU MICROELECTRONICS ASIA PTE LTD
#05-08, 151 Lorong Chuan
New Tech Park
Singapore 556741
Tel: (65) 281-0770
Fax: (65) 281-0220

<http://www.fmap.com.sg/>

F9905

© FUJITSU LIMITED Printed in Japan

All Rights Reserved.

The contents of this document are subject to change without notice. Customers are advised to consult with FUJITSU sales representatives before ordering.

The information and circuit diagrams in this document are presented as examples of semiconductor device applications, and are not intended to be incorporated in devices for actual use. Also, FUJITSU is unable to assume responsibility for infringement of any patent rights or other rights of third parties arising from the use of this information or circuit diagrams.

FUJITSU semiconductor devices are intended for use in standard applications (computers, office automation and other office equipment, industrial, communications, and measurement equipment, personal or household devices, etc.).
CAUTION:

Customers considering the use of our products in special applications where failure or abnormal operation may directly affect human lives or cause physical injury or property damage, or where extremely high levels of reliability are demanded (such as aerospace systems, atomic energy controls, sea floor repeaters, vehicle operating controls, medical devices for life support, etc.) are requested to consult with FUJITSU sales representatives before such use. The company will not be responsible for damages arising from such use without prior approval.

Any semiconductor devices have an inherent chance of failure. You must protect against injury, damage or loss from such failures by incorporating safety design measures into your facility and equipment such as redundancy, fire protection, and prevention of over-current levels and other abnormal operating conditions.

If any products described in this document represent goods or technologies subject to certain restrictions on export under the Foreign Exchange and Foreign Trade Law of Japan, the prior authorization by Japanese government will be required for export of those products from Japan.