











THREE PHASE FULLWAVE BRIDGE RECTIFIER ASSEMBLIES

SUPER FAST RECOVERY, FAST RECOVERY, GENERAL PURPOSE												
TYPE NUMBER	PEAK INVERSE VOLTAGE	MAXIMUM AVERAGE DC OUTPUT CURRENT		PEAK 1 CYCLE SURGE CURRENT $t_p = 8.3$ msec.	MAXIMUM FORWARD VOLTAGE (PULSED) PER LEG		MAXIMUM REVERSE CURRENT @ PIV/LEG		MAX. THERMAL RESIS. $R_{\theta JC}$	MAX. REVERSE RECOVERY TIME ①	PKG. STYLE	
		Amps			Amps	V	A	μAmps				
		Volts	55°C					100°C				25°C
S25A315HE▼	150	25	18	150	1.4	9.0	5.0	100	1.5	30		
S25A360S7	600	18	13.5	100	1.75	9.0	5.0	100	1.5	70		
S25A360FR	600	20	15	125	1.6	9.0	5.0	100	1.5	150		
S25A3100FR▼	1000	18	13.5	100	1.75	9.0	5.0	100	1.5	250		
S25A3100▼	1000	18.5	15.0	150	1.4	9.0	5.0	100	1.5	5000		
SL6315HEL▼	150	10.5	7.5	60	1.2	3.0	5.0	100	4.5	30		
SL6360FRL	600	6.0	4.5	25	1.7	3.0	5.0	100	4.5	150		
SL6360L	600	7.5	5.5	50	1.4	3.0	5.0	100	4.5	5000		
SL63100L▼	1000	7.5	5.5	50	1.4	3.0	5.0	100	4.5	5000		
SL6315HE▼	150	10.5	7.5	60	1.2	3.0	5.0	100	4.5	30		
SL6360FR	600	6.0	4.5	25	1.7	3.0	5.0	100	4.5	150		
SL63100▼	1000	7.5	5.5	50	1.4	3.0	5.0	100	4.5	5000		
SL30315HEL▼	150	30	22	150	1.0	6.0	10	100	1.25	30		
SL30360S7L	600	20	15	100	1.75	9.0	5.0	100	1.25	70		
SL30360FRL	600	22.5	16.5	125	1.6	9.0	5.0	100	1.25	150		
SL30360L	600	30	22	150	1.3	9.0	5.0	100	1.25	5000		
SL303100FRL▼	1000	20	15	100	1.75	9.0	5.0	100	1.25	250		
SL303100L▼	1000	30	22	150	1.4	9.0	5.0	100	1.25	5000		
SL30315HE▼	150	30	22	150	1.0	6.0	10	100	1.25	30		
SL30360S7	600	20	15	100	1.75	9.0	5.0	100	1.25	70		
SL30360FR	600	22.5	16.5	125	1.6	9.0	5.0	100	1.25	150		
SL303100FR▼	1000	20	15	100	1.75	9.0	5.0	100	1.25	250		
SL303100▼	1000	30	22	150	1.4	9.0	5.0	100	1.25	5000		
S6A315HE▼	150	9.0	6.5	60	1.2	3.0	5.0	100	4.0	30		
S6A360FR	600	5.0	3.5	25	1.7	3.0	2.0	50	4.0	150		
S6A3100▼	1000	5.5	4.0	50	1.4	3.0	2.0	50	4.0	5000		
S10A315HE▼	150	15	9.0	150	1.0	6.0	10	100	3.0	30		
S10A360S7	600	8.6	6.3	100	1.75	9.0	5.0	100	3.0	70		
S10A360FR	600	9.5	7.0	100	1.6	9.0	2.0	100	3.0	150		
S10A3100FR▼	1000	8.6	6.3	100	1.75	9.0	5.0	100	3.0	250		
S10A3100▼	1000	11	8.0	125	1.4	9.0	2.0	100	3.0	5000		
S50A315HE▼	150	50	33	375	1.0	10	20	250	0.9	30		
S50A360S7	600	45	30	300	1.35	10	20	200	0.9	70		
S50A360FR	600	50	33	375	1.2	10	9.0	180	0.9	150		
S50A3100FR▼	1000	45	30	300	1.35	10	20	200	0.9	250		
S50A3100▼	1000	50	33	375	1.2	10	9.0	180	0.9	5000		

(Three phase Bridge Rectifier Assemblies, Continued on Next Page.)

- Add suffix L for leaded version; contact the factory for details.

THREE PHASE FULL WAVE BRIDGE RECTIFIER ASSEMBLIES (Continued)

SUPER FAST RECOVERY. FAST RECOVERY. GENERAL PURPOSE											
TYPE NUMBER	PEAK INVERSE VOLTAGE	MAXIMUM AVERAGE DC OUTPUT CURRENT		PEAK 1 CYCLE SURGE CURRENT $t_p = 8.3$ msec.	MAXIMUM FORWARD VOLTAGE (PULSED) PER LEG		MAXIMUM REVERSE CURRENT @ PIV/LEG		MAX. THERMAL RESIS. $R_{\theta JC}$	MAX. REVERSE RECOVERY TIME ^①	PKG. STYLE
		Amps					μAmps				
		Volts	55°C		100°C	Amps	V	A			
S424CA▼	150	44	23	375	1.0	10	20	200	0.85	30	
S424GC	600	33	17.5	300	1.35	10	20	200	0.85	70	
S424GE	600	37	19.5	300	1.2	10	10	200	0.85	150	
S424IE▼	1000	33	17.5	300	1.35	10	20	200	0.85	175	
S424IH▼	1000	40	21	325	1.2	10	10	200	0.85	5000	
*M19500/483-01	200	25	18.5	150	1.3	39	1.0	200	-	2000	
*M19500/483-02	400	25	18.5	150	1.3	39	1.0	200	-	2000	
*M19500/483-03	600	25	18.5	150	1.3	39	1.0	200	-	2000	
S455DA	200	35	23	150	1.1	6.0	10	100	1.25	30	
S455GA	600	12	8.0	60	2.5	2.0	10	100	1.25	30	
S455GC	600	22	15	100	1.75	9.0	5.0	100	1.25	70	
S455GE	600	25	17	125	1.6	9.0	5.0	100	1.25	150	
S455GH	600	30	20	150	1.4	9.0	5.0	100	1.25	5000	
S455IE▼	1000	22	15	100	1.75	9.0	5.0	100	1.25	175	
S455IH▼	1000	30	20	150	1.4	9.0	5.0	100	1.25	5000	

Notes:

* MIL-PRF-19500 QPL Product.

-All ratings are at $T_C = 25^\circ\text{C}$ unless otherwise specified.

-Maximum operating and storage temperature range -55°C to $+150^\circ\text{C}$.

① Reverse recovery time conditions: $I_f = 0.5\text{A}$, $I_r = 1.0\text{A}$, t_{rr} measured when rectifier recovers to 0.25 Amps.

t_{rr} measured on discrete rectifiers prior to assembly.

▼150 Volt devices are available in; 50 & 100 Volt versions. ▼1000 Volt devices are available in 200, 400, 600 & 800 Volt versions.

Most devices are available in other Voltage and/or current ratings. Please contact the factory or a Sensitron Sales Representative for details.

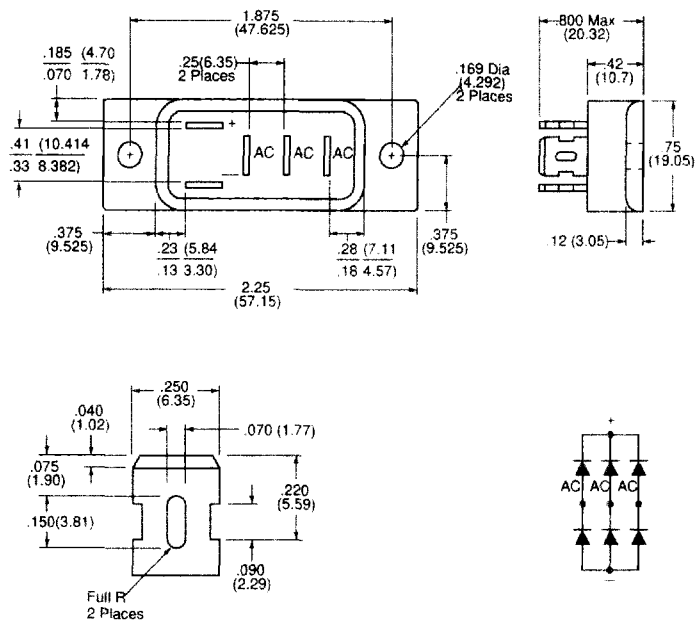

FIG. 404

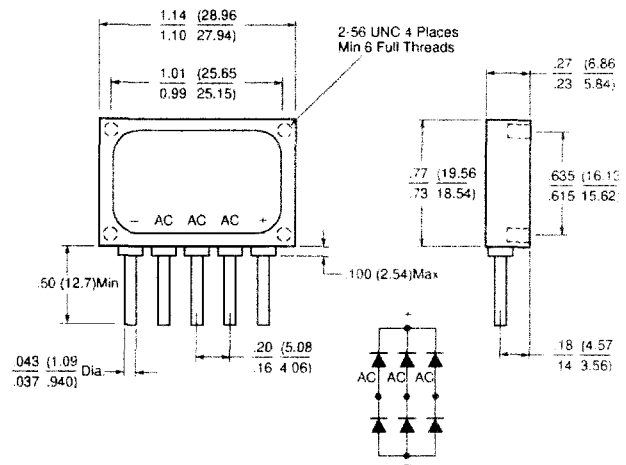

FIG. 405L

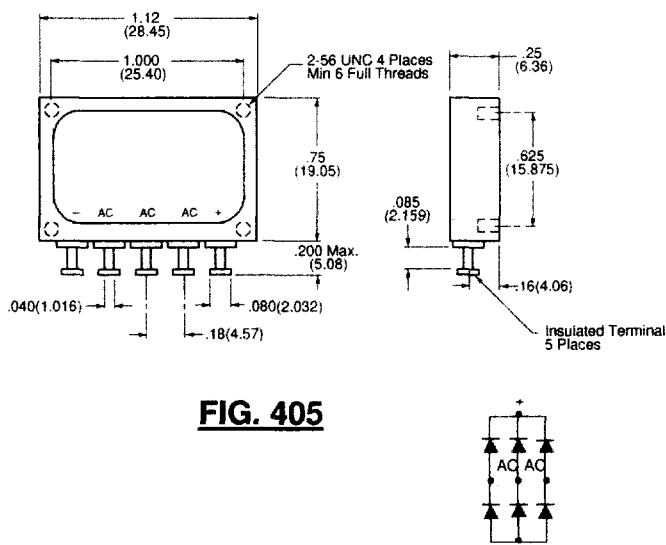

FIG. 405

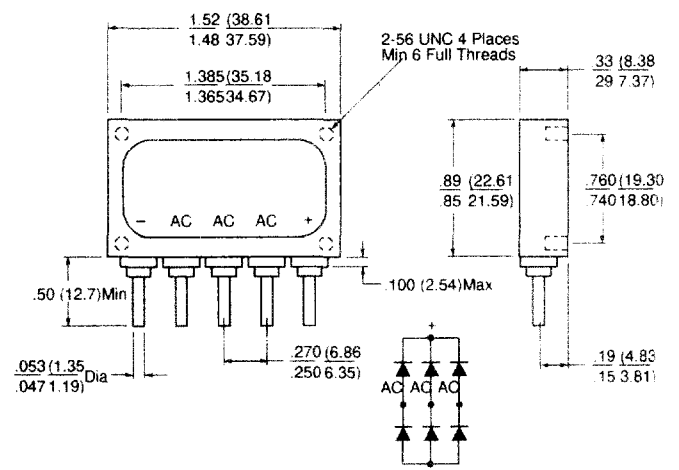

FIG. 406L

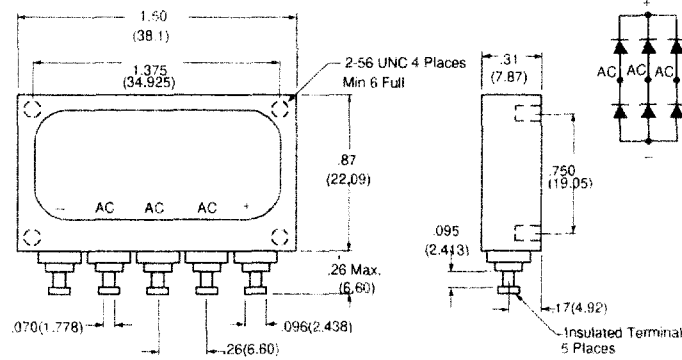

FIG. 406

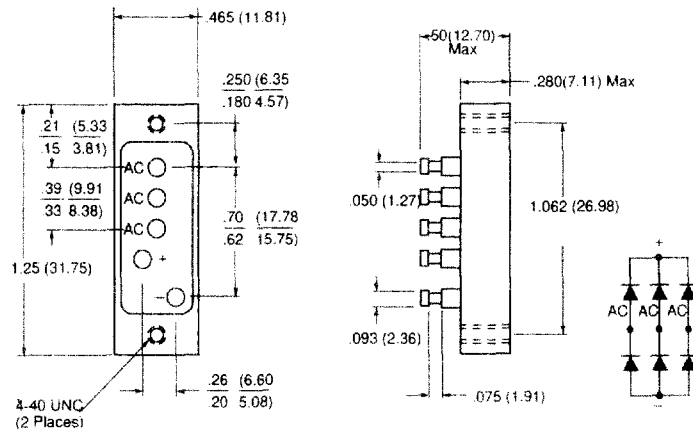

FIG. 409

Option A - .128" Thru Hole

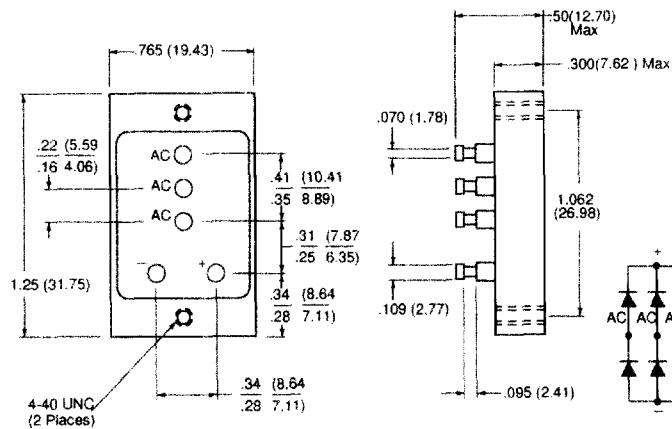

FIG. 410

Option A - .128" Thru Hole

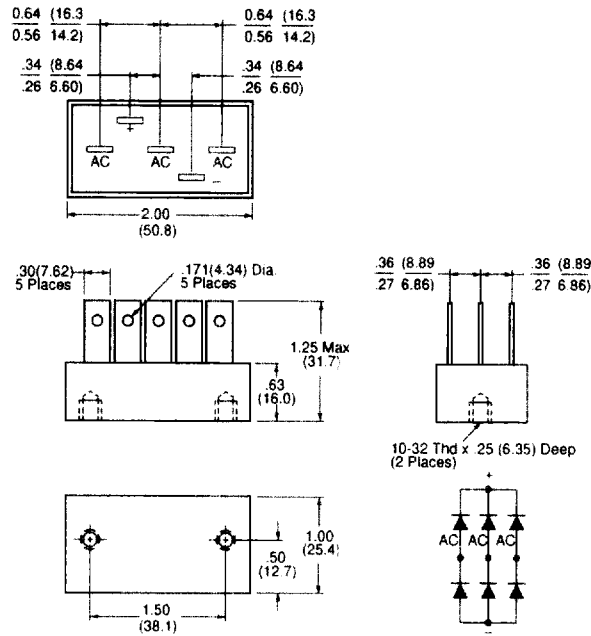

FIG. 412

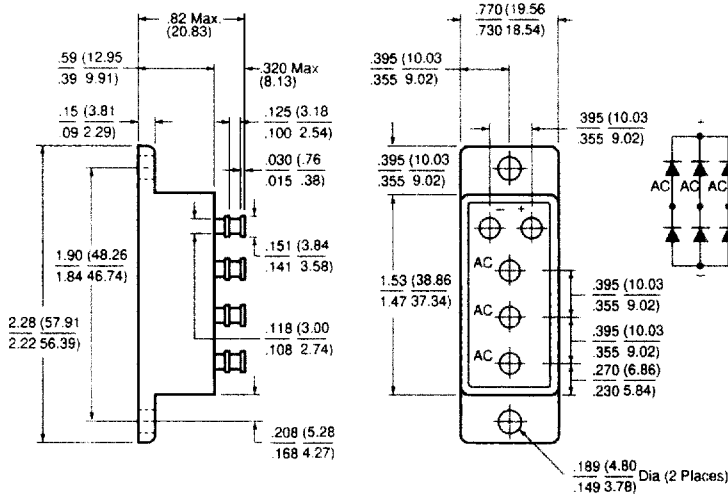

FIG. 424

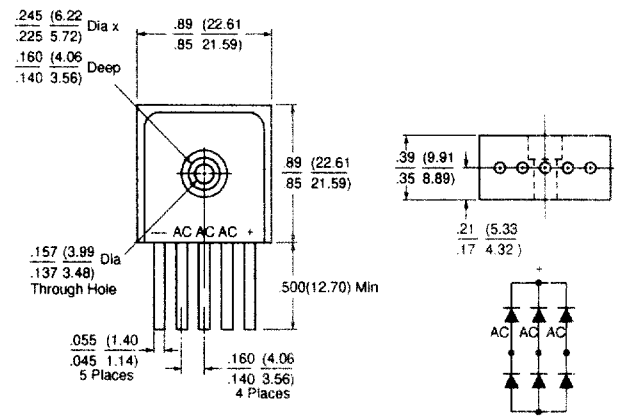

FIG. 455