

FEATURES

- ❑ 64K x 1 Static RAM with Separate I/O, Chip Select Powerdown
- ❑ Auto-Powerdown™ Design
- ❑ Advanced CMOS Technology
- ❑ High Speed — to 8 ns maximum
- ❑ Low Power Operation
 - Active: 135 mW typical at 35 ns
 - Standby: 500 μW typical
- ❑ Data Retention at 2 V for Battery Backup Operation
- ❑ Plug Compatible with IDT 7187, Cypress CY7C187
- ❑ Package Styles Available:
 - 22-pin Plastic DIP
 - 22-pin Sidebrazed, Hermetic DIP
 - 22-pin CerDIP
 - 24-pin Plastic SOIC
 - 24-pin Plastic SOJ
 - 22-pin Ceramic LCC

DESCRIPTION

The L7C187 is a high-performance, low-power CMOS static RAM. The storage circuitry is organized as 65,536 words by 1 bit per word. This device is available in seven speeds with maximum access times from 8 ns to 35 ns.

Operation is from a single +5 V power supply and all interface signals are TTL compatible. Power consumption is 135 mW (typical) at 35 ns. Dissipation drops to 75 mW (typical) when the memory is deselected (\overline{CE} is high).

Two standby modes are available. Proprietary Auto-Powerdown™ circuitry reduces power consumption automatically during read or write accesses which are longer than the minimum access time, or when the memory is deselected. In addition,

data may be retained in inactive storage with a supply voltage as low as 2 V. The L7C187 consumes only 30 μW (typical) at 3 V, allowing effective battery backup operation.

The L7C187 provides asynchronous (unlocked) operation with matching access and cycle times. An active-low Chip Enable and a three-state output simplify the connection of several chips for increased capacity.

Memory locations are specified on address pins A0 through A15. Reading from a designated location is accomplished by presenting an address and driving \overline{CE} low while \overline{WE} remains high. The data in the addressed memory location will then appear on the Data Out pin within one access time. The output pin stays in a high-impedance state when \overline{CE} is high or \overline{WE} is low.

Writing to an addressed location is accomplished when the active-low \overline{CE} and \overline{WE} inputs are both low. Either signal may be used to terminate the write operation. Data In and Data Out signals have the same polarity.

Latchup and static discharge protection are provided on-chip. The L7C187 can withstand an injection current of up to 200 mA on any pin without damage.

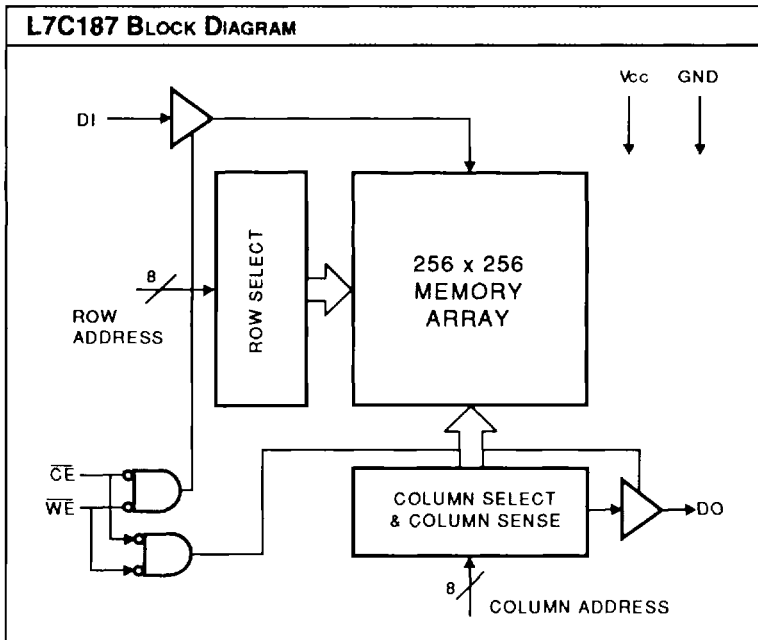

MAXIMUM RATINGS Above which useful life may be impaired (Notes 1, 2)	
Storage temperature	-65°C to +150°C
Operating ambient temperature	-55°C to +125°C
V _{CC} supply voltage with respect to ground	-0.5 V to +7.0 V
Input signal with respect to ground	-3.0 V to +7.0 V
Signal applied to high impedance output	-3.0 V to +7.0 V
Output current into low outputs	25 mA
Latchup current	> 200 mA

OPERATING CONDITIONS To meet specified electrical and switching characteristics		
Mode	Temperature Range (Ambient)	Supply Voltage
Active Operation, Commercial	0°C to +70°C	4.5 V ≤ V _{CC} ≤ 5.5 V
Active Operation, Military	-55°C to +125°C	4.5 V ≤ V _{CC} ≤ 5.5 V
Data Retention, Commercial	0°C to +70°C	2.0 V ≤ V _{CC} ≤ 5.5 V
Data Retention, Military	-55°C to +125°C	2.0 V ≤ V _{CC} ≤ 5.5 V

ELECTRICAL CHARACTERISTICS Over Operating Conditions (Note 5)						
Symbol	Parameter	Test Condition	Min	Typ	Max	Unit
V _{OH}	Output High Voltage	I _{OH} = -4.0 mA, V _{CC} = 4.5 V	2.4			V
V _{OL}	Output Low Voltage	I _{OL} = 8.0 mA			0.4	V
V _{IH}	Input High Voltage		2.0		V _{CC} + 0.3	V
V _{IL}	Input Low Voltage	(Note 3)	-3.0		0.8	V
I _{ix}	Input Current	GND ≤ V _{IN} ≤ V _{CC}	-10		+10	μA
I _{OZ}	Output Leakage Current	GND ≤ V _{OUT} ≤ V _{CC} , CE = V _{CC}	-10		+10	μA
I _{OS}	Output Short Current	V _{OUT} = GND, V _{CC} = Max (Note 4)			-350	mA
I _{CC2}	V _{CC} Current, TTL Inactive	(Note 7)		15	30	mA
I _{CC3}	V _{CC} Current, CMOS Standby	(Note 8)		100	500	μA
I _{CC4}	V _{CC} Current, Data Retention	V _{CC} = 3.0 V (Note 9)		10	250	μA
C _{IN}	Input Capacitance	Ambient Temp = 25°C, V _{CC} = 5.0 V			5	pF
C _{OUT}	Output Capacitance	Test Frequency = 1 MHz (Note 10)			7	pF

Symbol	Parameter	Test Condition	L7C187-							Unit
			35	25	20	15	12	10	8	
I _{CC1}	V _{CC} Current, Active	(Note 6)	75	100	125	160	190	205	225	mA



SWITCHING CHARACTERISTICS Over Operating Range (ns)

Symbol		Parameter		L7C187-													
				35		25		20		15		12		10		8	
				Min	Max	Min	Max	Min	Max	Min	Max	Min	Max	Min	Max	Min	Max
t_{AVAV}	Read Cycle Time	35		25		20		15		12		10		8			
t_{AVQV}	Address Valid to Output Valid (13, 14)		35		25		20		15		12		10		8		
t_{AXOX}	Address Change to Output Change	3		3		3		3		3		3		3			
t_{CLOV}	Chip Enable Low to Output Valid (13, 15)		35		25		20		15		12		10		8		
t_{CLOZ}	Chip Enable Low to Output Low Z (20, 21)	3		3		3		3		3		3		3			
t_{CHOZ}	Chip Enable High to Output High Z (20, 21)		15		10		8		8		5		4		4		
t_{PU}	Input Transition to Power Up (10, 19)	0		0		0		0		0		0		0			
t_{PD}	Power Up to Power Down (10, 19)		35		25		20		20		20		18		15		
t_{CHVL}	Chip Enable High to Data Retention (10)	0		0		0		0		0		0		0			

2

READ CYCLE — ADDRESS CONTROLLED (Notes 13, 14)

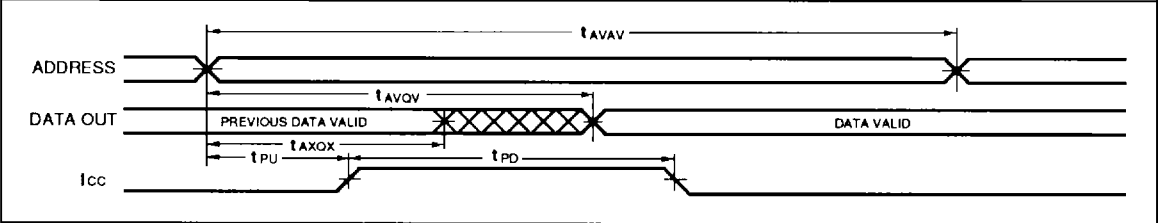

READ CYCLE — CE CONTROLLED (Notes 13, 15)

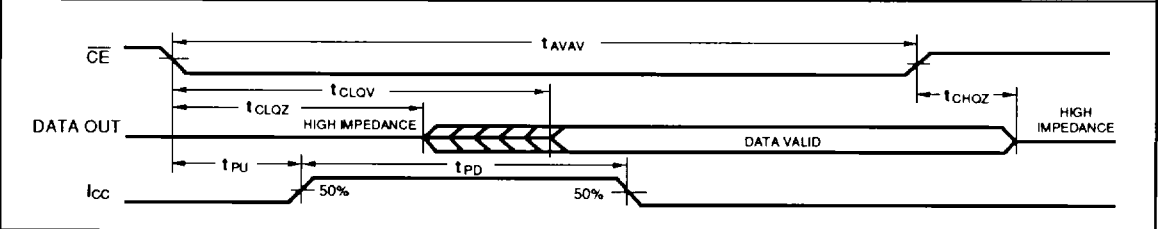

DATA RETENTION

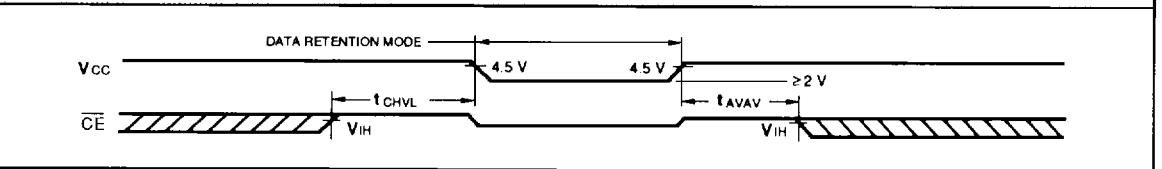

SWITCHING CHARACTERISTICS Over Operating Range (ns)

WRITE CYCLE (Notes 5, 11, 12, 22, 23, 24)		L7C187-													
		35		25		20		15		12		10		8	
Symbol	Parameter	Min	Max	Min	Max	Min	Max	Min	Max	Min	Max	Min	Max	Min	Max
tAVAV	Write Cycle Time	25		20		20		15		12		10		8	
tCLEW	Chip Enable Low to End of Write Cycle	25		15		15		12		10		8		8	
tAVBW	Address Valid to Beginning of Write Cycle	0		0		0		0		0		0		0	
tAVEW	Address Valid to End of Write Cycle	25		15		15		12		10		8		8	
tEWAX	End of Write Cycle to Address Change	0		0		0		0		0		0		0	
tWLEW	Write Enable Low to End of Write Cycle	20		15		15		12		10		8		6.5	
tDVEW	Data Valid to End of Write Cycle	15		10		10		7		6		5		4	
tEWDX	End of Write Cycle to Data Change	0		0		0		0		0		0		0	
tWHOZ	Write Enable High to Output Low Z (20, 21)	0		0		0		0		0		0		0	
tWLOZ	Write Enable Low to Output High Z (20, 21)		10		7		7		5		4		4		3

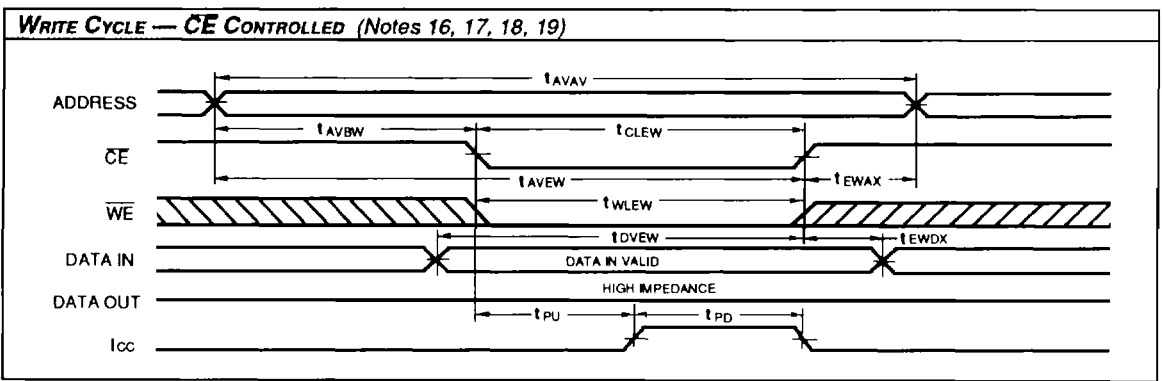
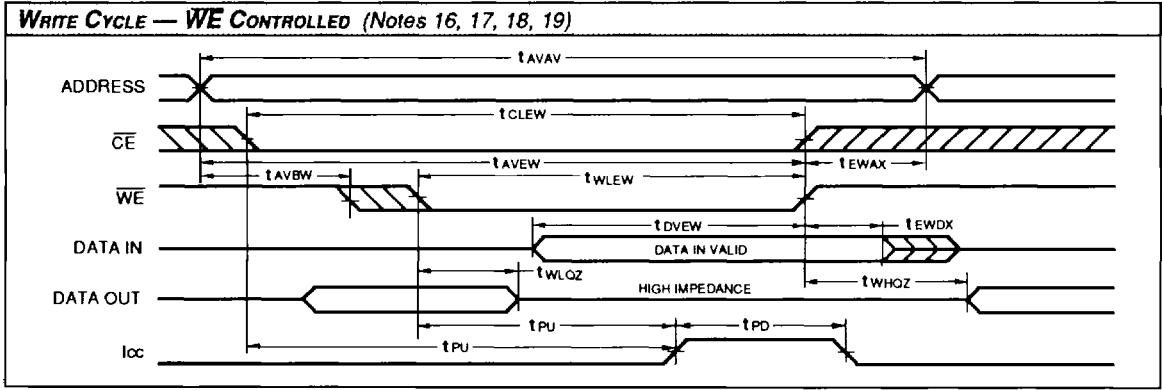

NOTES

1. Maximum Ratings indicate stress specifications only. Functional operation of these products at values beyond those indicated in the Operating Conditions table is not implied. Exposure to maximum rating conditions for extended periods may affect reliability of the tested device.
2. The products described by this specification include internal circuitry designed to protect the chip from damaging substrate injection currents and accumulations of static charge. Nevertheless, conventional precautions should be observed during storage, handling, and use of these circuits in order to avoid exposure to excessive electrical stress values.
3. This product provides hard clamping of transient undershoot. Input levels below ground will be clamped beginning at -0.6 V . A current in excess of 100 mA is required to reach -2 V . The device can withstand indefinite operation with inputs as low as -3 V subject only to power dissipation and bond wire fusing constraints.
4. Duration of the output short circuit should not exceed 30 seconds.
5. A series of normalized curves on pages 2-8 through 2-11 of this data book supply the designer with typical DC and AC parametric information for Logic Devices Static RAMs. These curves may be used to determine device characteristics at various temperatures and voltage levels.
6. Tested with all address and data inputs changing at the maximum cycle rate. The device is continuously enabled for writing, i.e., $\text{CE} \leq \text{VIL}$, $\text{WE} \leq \text{VIL}$. Input pulse levels are 0 to 3.0 V .
7. Tested with outputs open and all address and data inputs changing at the maximum read cycle rate. The device is continuously disabled, i.e., $\text{CE} \geq \text{VIH}$.
8. Tested with outputs open and all address and data inputs stable. The device is continuously disabled, i.e., $\text{CE} = \text{VCC}$. Input levels are within 0.2 V of VCC or ground.
9. Data retention operation requires that VCC never drop below 2.0 V . CE must be $\geq \text{VCC} - 0.2\text{ V}$. For all other inputs $\text{VIN} \geq \text{VCC} - 0.2\text{ V}$ or $\text{VIN} \leq 0.2\text{ V}$ is required to ensure full powerdown.
10. These parameters are guaranteed but not 100% tested.
11. Test conditions assume input transition times of less than 3 ns , reference levels of 1.5 V , output loading for specified IOI , and

- IOH plus 30 pF (Fig. 1a), and input pulse levels of 0 to 3.0 V (Fig. 2).
 12. Each parameter is shown as a minimum or maximum value. Input requirements are specified from the point of view of the external system driving the chip. For example, t_{VIEW} is specified as a minimum since the external system must supply at least that much time to meet the worst-case requirements of all parts. Responses from the internal circuitry are specified from the point of view of the device. Access time, for example, is specified as a maximum since worst-case operation of any device always provides data within that time.
 13. WE is high for the read cycle.
 14. The chip is continuously selected (CE low).
 15. All address lines are valid prior to and coincident with the CE transition to low.
 16. The internal write cycle of the memory is defined by the overlap of CE low and WE low. Both signals must be low to initiate a write. Either signal can terminate a write by going high. The address, data, and control input setup and hold times should be referenced to the signal that falls last or rises first.
 17. If WE goes low before or concurrent with CE going low, the output remains in a high impedance state.
 18. If CE goes high before or concurrent with WE going high, the output remains in a high impedance state.
 19. Powerup from ICC2 to ICC1 occurs as a result of any of the following conditions:
 - a. Falling edge of CE .
 - b. Falling edge of WE (CE active).
 - c. Transition on any address line (CE active).
 - d. Transition on any data line (CE and WE active).
- The device automatically powers down from ICC2 to ICC1 after t_{PD} has elapsed from any of the prior conditions. This means that power dissipation is dependent on only cycle rate, and is not on Chip Select pulse width.
20. At any given temperature and voltage condition, output disable time is less than output enable time for any given device.
 21. Transition is measured $\pm 200\text{ mV}$ from steady state voltage with specified loading in Fig. 1b. This parameter is sampled and not 100% tested.
 22. All address timings are referenced from the last valid address line to the first transitioning address line.
 23. CE or WE must be high during address transitions.
 24. This product is a very high speed device and care must be taken during testing in order to realize valid test information. Inadequate attention to setups and procedures can cause a good part to be rejected as faulty. Long high inductance leads that cause supply bounce must be avoided by bringing the VCC and ground planes directly up to the contactor fingers. A $0.01\text{ }\mu\text{F}$ high frequency capacitor is also required between VCC and ground. To avoid signal reflections, proper terminations must be used.

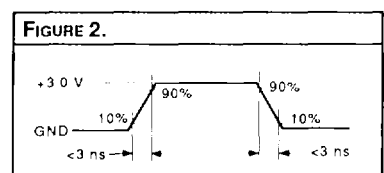
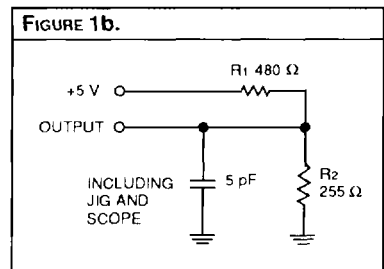
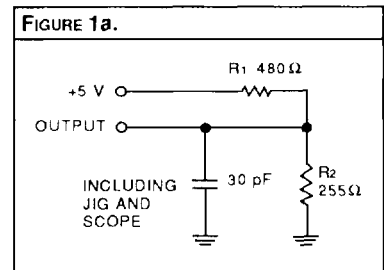

DEVICES INCORPORATED

Memory Products

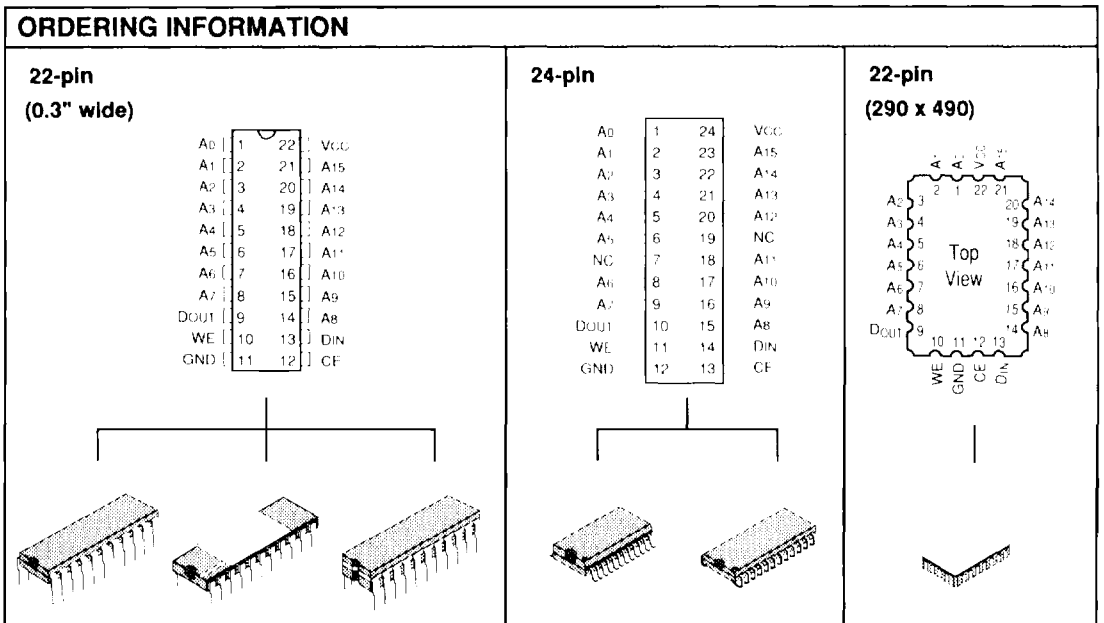

Speed	Plastic DIP (P8)	Sidebrazed Hermetic DIP (D8)	CerDIP (C3)	Plastic SOIC (.300" — U1)	Plastic SOJ (.300" — W1)	Ceramic Leadless Chip Carrier (K4)
0°C to +70°C — COMMERCIAL SCREENING						
35 ns	L7C187PC35	L7C187DC35	L7C187CC35	L7C187UC35	L7C187WC35	L7C187KC35
25 ns	• • 25	• • 25	• • 25	• • 25	• • 25	• • 25
20 ns	• • 20	• • 20	• • 20	• • 20	• • 20	• • 20
15 ns	• • 15	• • 15	• • 15	• • 15	• • 15	• • 15
12 ns	• • 12	• • 12	• • 12	• • 12	• • 12	• • 12
10 ns	• • 10	• • 10	• • 10	• • 10	• • 10	• • 10
8 ns	• • 8	• • 8	• • 8	• • 8	• • 8	• • 8
-55°C to +125°C — COMMERCIAL SCREENING						
35 ns		L7C187DM35	L7C187CM35			L7C187KM35
25 ns		• • 25	• • 25			• • 25
20 ns		• • 20	• • 20			• • 20
15 ns		• • 15	• • 15			• • 15
12 ns		• • 12	• • 12			• • 12
10 ns		• • 10	• • 10			• • 10
8 ns						
-55°C to +125°C — EXTENDED SCREENING						
35 ns		L7C187DME35	L7C187CME35			L7C187KME35
25 ns		• • 25	• • 25			• • 25
20 ns		• • 20	• • 20			• • 20
15 ns		• • 15	• • 15			• • 15
12 ns		• • 12	• • 12			• • 12
10 ns		• • 10	• • 10			• • 10
8 ns						
-55°C to +125°C — MIL-STD-883 COMPLIANT						
35 ns		L7C187DMB35	L7C187CMB35			L7C187KMB35
25 ns		• • 25	• • 25			• • 25
20 ns		• • 20	• • 20			• • 20
15 ns		• • 15	• • 15			• • 15
12 ns		• • 12	• • 12			• • 12
10 ns		• • 10	• • 10			• • 10
8 ns						

