

Features

- 60V/50A,
 $R_{DS(ON)} = 10m$ (typ.)@ $V_{GS} = 10V$
- Super High Dense Cell Design
- Ultra Low On-Resistance
- 100% avalanche tested
- Lead Free and Green Devices Available
 (RoHS Compliant)

Applications

- DC-DC Converters and Off-line UPS

Pin Description

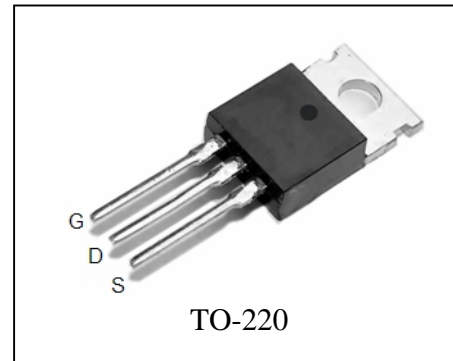

Absolute Maximum Ratings

| Symbol | Parameter | Rating | Unit |
|--|---|--|--------------|
| Common Ratings ($T_C = 25^\circ C$ Unless Otherwise Noted) | | | |
| V_{DSS} | Drain-Source Voltage | 60 | V |
| V_{GSS} | Gate-Source Voltage | ± 25 | |
| T_J | Maximum Junction Temperature | 175 | $^\circ C$ |
| T_{STG} | Storage Temperature Range | -55 to 175 | $^\circ C$ |
| I_S | Diode Continuous Forward Current | $T_C = 25^\circ C$ 50 ^① | A |
| Mounted on Large Heat Sink | | | |
| I_{DP} | 300 μs Pulse Drain Current Tested | $T_C = 25^\circ C$ 200 ^② | A |
| I_D | Continuous Drain Current ($V_{GS} = 10V$) | $T_C = 25^\circ C$ 50 ^① | A |
| | | $T_C = 100^\circ C$ 44 | |
| P_D | Maximum Power Dissipation | $T_C = 25^\circ C$ 79 | W |
| | | $T_C = 100^\circ C$ 39 | W |
| $R_{\theta JC}$ | Thermal Resistance-Junction to Case | 1.9 | $^\circ C/W$ |
| Drain-Source Avalanche Ratings | | | |
| E_{AS} ^③ | Avalanche Energy, Single Pulsed | 110 | mJ |

Electrical Characteristics ($T_C=25^\circ\text{C}$ Unless Otherwise Noted)

| Symbol | Parameter | Test Condition | RU6050R | | | Unit |
|---|----------------------------------|---|---------|------|-----------|------------|
| | | | Min. | Typ. | Max. | |
| Static Characteristics | | | | | | |
| BV_{DSS} | Drain-Source Breakdown Voltage | $V_{GS}=0V, I_{DS}=250\mu A$ | 60 | | | V |
| I_{DSS} | Zero Gate Voltage Drain Current | $V_{DS}=60V, V_{GS}=0V$ $T_J=85^\circ\text{C}$ | | | 1 | μA |
| | | | | | 30 | |
| $V_{GS(th)}$ | Gate Threshold Voltage | $V_{DS}=V_{GS}, I_{DS}=250\mu A$ | 2 | 3 | 4 | V |
| I_{GSS} | Gate Leakage Current | $V_{GS}=\pm 25V, V_{DS}=0V$ | | | ± 100 | nA |
| $R_{DS(ON)}^{(4)}$ | Drain-Source On-state Resistance | $V_{GS}=10V, I_{DS}=50A$ | | 10 | 12 | m Ω |
| Diode Characteristics | | | | | | |
| $V_{SD}^{(4)}$ | Diode Forward Voltage | $I_{SD}=50A, V_{GS}=0V$ | | | 1.2 | V |
| t_{rr} | Reverse Recovery Time | $I_{SD}=50A, di_{SD}/dt=100A/\mu s$ | | 32 | | ns |
| Q_{rr} | Reverse Recovery Charge | | | 39 | | nC |
| Dynamic Characteristics ⁽⁵⁾ | | | | | | |
| R_G | Gate Resistance | $V_{GS}=0V, V_{DS}=0V, F=1\text{MHz}$ | | 1.6 | | Ω |
| C_{iss} | Input Capacitance | $V_{GS}=0V,$ $V_{DS}=30V,$ Frequency=1.0MHz | | 1670 | | pF |
| C_{oss} | Output Capacitance | | | 340 | | |
| C_{riss} | Reverse Transfer Capacitance | | | 145 | | |
| $t_{d(ON)}$ | Turn-on Delay Time | | | 10 | | |
| t_r | Turn-on Rise Time | $V_{DD}=30V, R_L=0.6\Omega,$ $I_{DS}=50A, V_{GEN}=10V,$ $R_G=4.7\Omega$ | | 86 | | |
| $t_{d(OFF)}$ | Turn-off Delay Time | | | 34 | | |
| t_f | Turn-off Fall Time | | | 26 | | |
| Gate Charge Characteristics ⁽⁵⁾ | | | | | | |
| Q_g | Total Gate Charge | $V_{DS}=48V, V_{GS}=10V,$ $I_{DS}=50A$ | | 25 | | nC |
| Q_{gs} | Gate-Source Charge | | | 9 | | |
| Q_{gd} | Gate-Drain Charge | | | 8 | | |

- Notes: ① Calculated continuous current based on maximum allowable junction temperature.
 ② Pulse width limited by safe operating area.
 ③ Limited by $T_{Jmax}, I_{AS}=21A, V_{DD}=48V, R_G=50\Omega$, Starting $T_J=25^\circ\text{C}$.
 ④ Pulse test; Pulse width $\leq 300\mu s$, duty cycle $\leq 2\%$.
 ⑤ Guaranteed by design, not subject to production testing.

Typical Characteristics

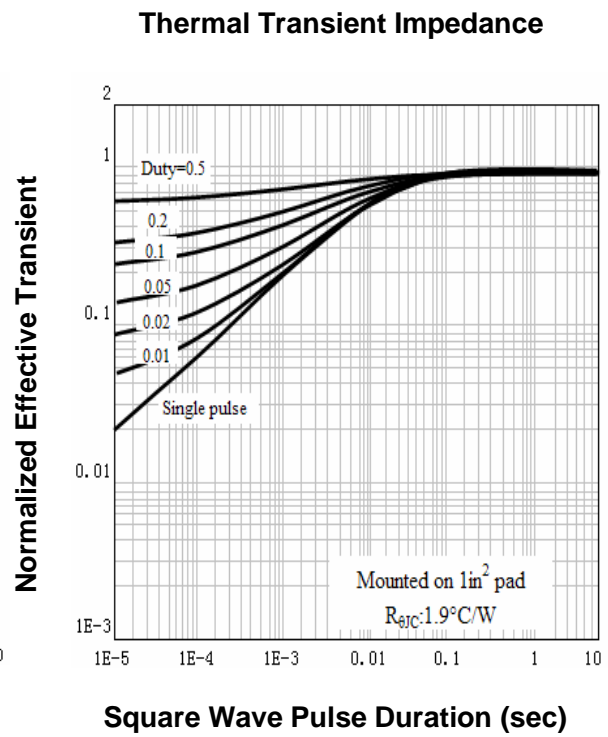
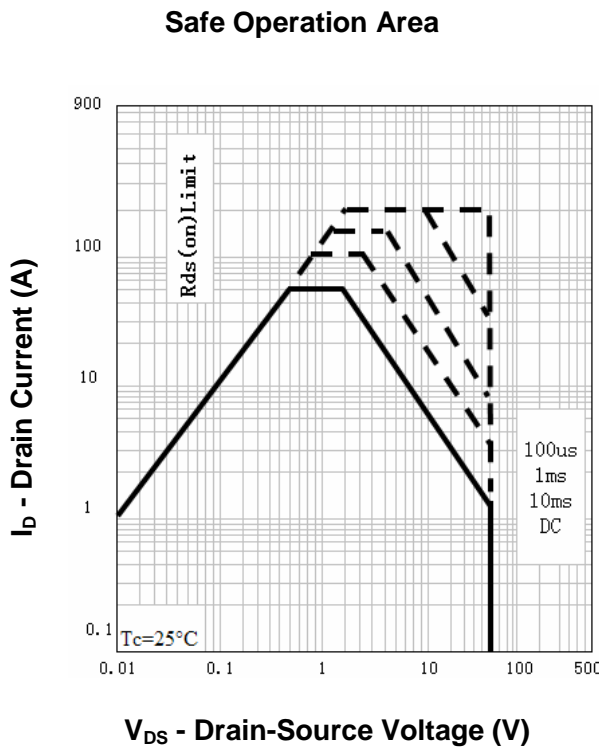
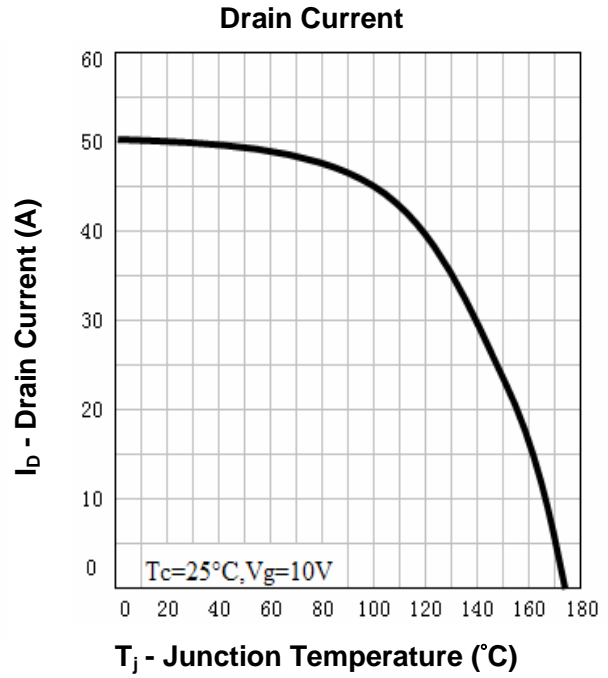
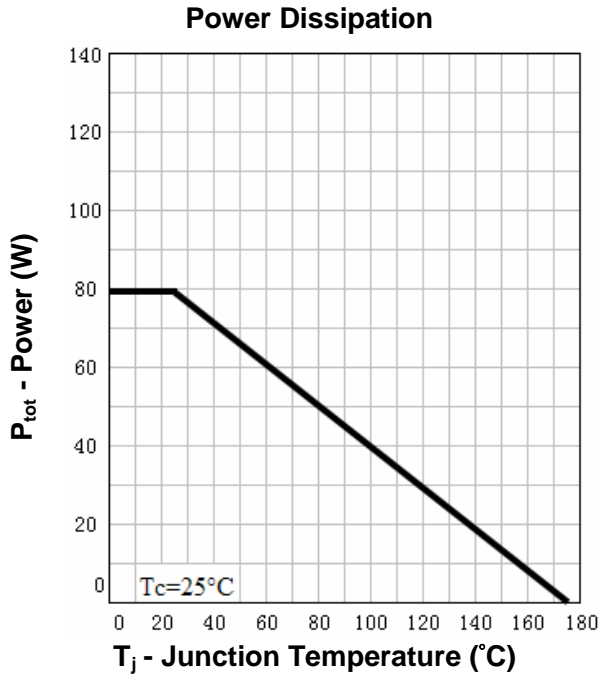

Typical Characteristics

Output Characteristics

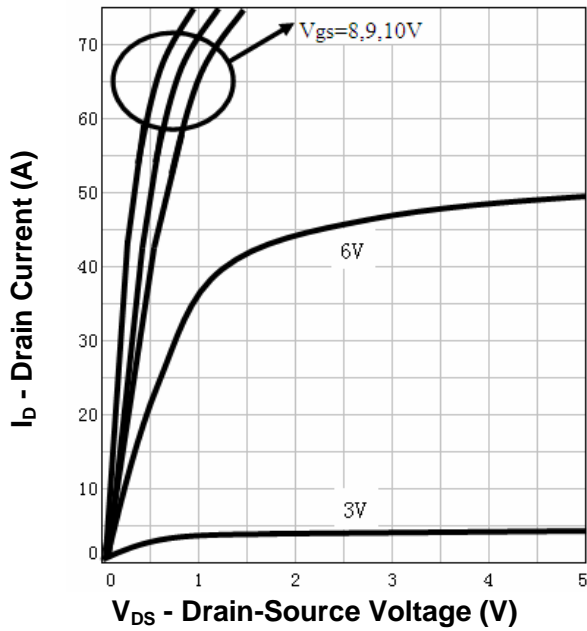

Drain-Source On Resistance

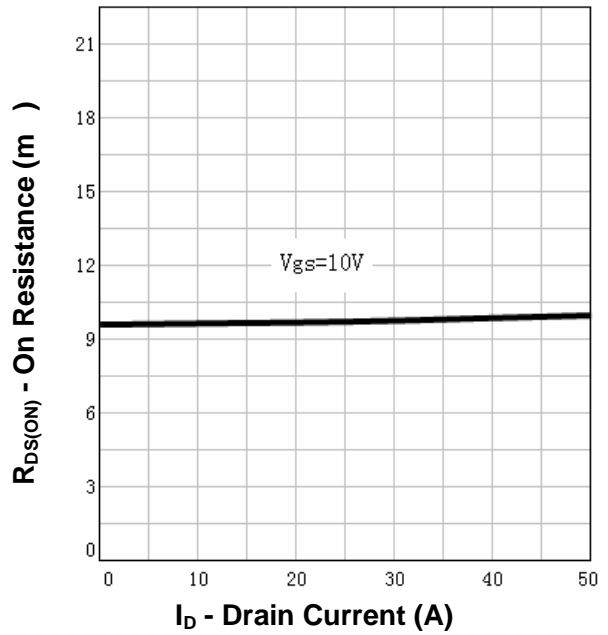

Drain-Source On Resistance

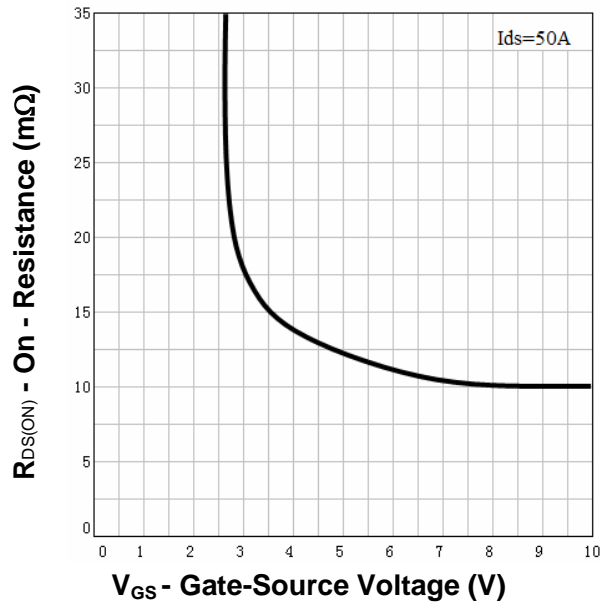

Gate Threshold Voltage

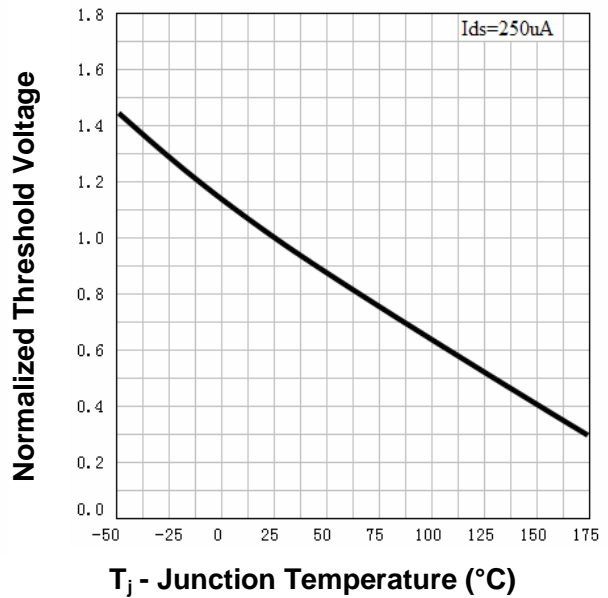

Typical Characteristics

Drain-Source On Resistance

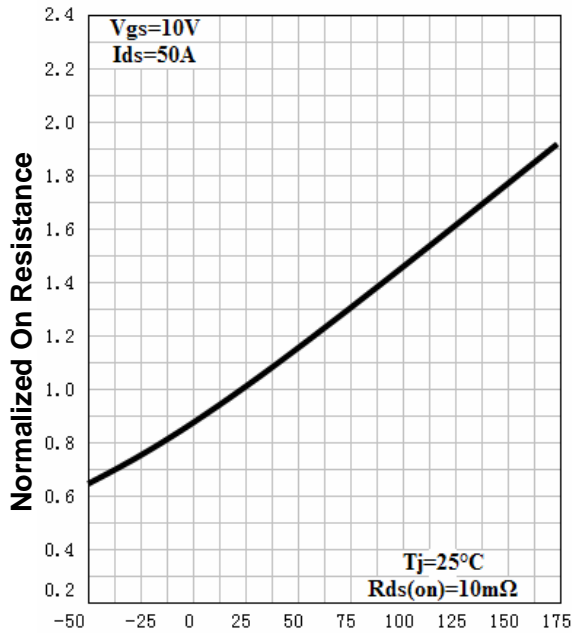

T_J - Junction Temperature (°C)

Source-Drain Diode Forward

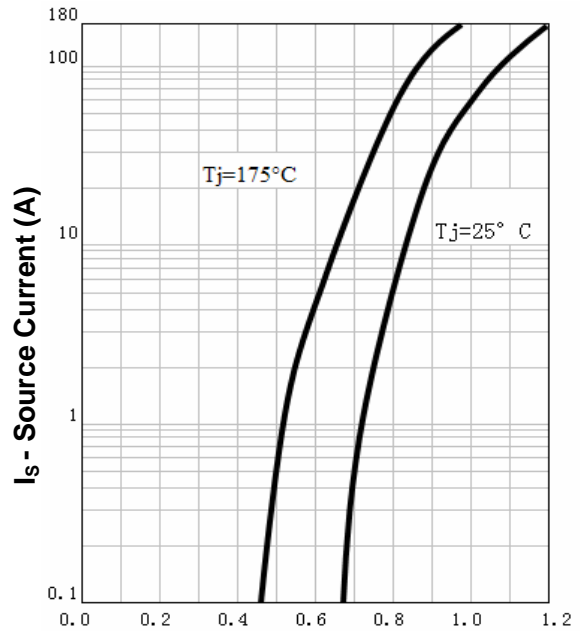

V_{SD} - Source-Drain Voltage (V)

Capacitance

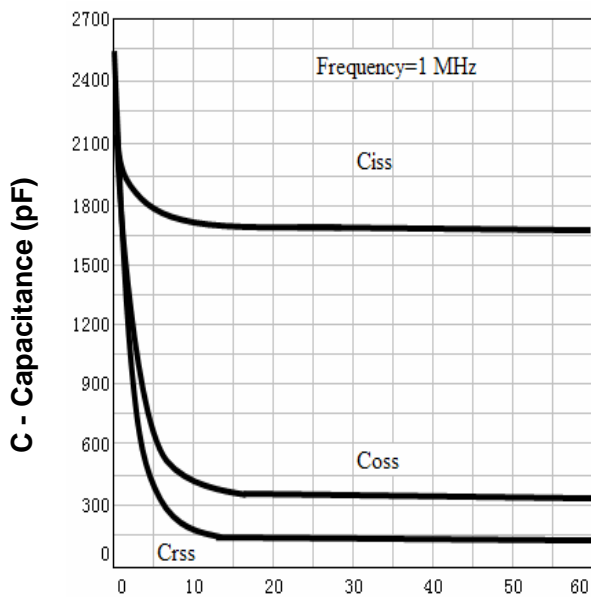

V_{DS} - Drain-Source Voltage (V)

Gate Charge

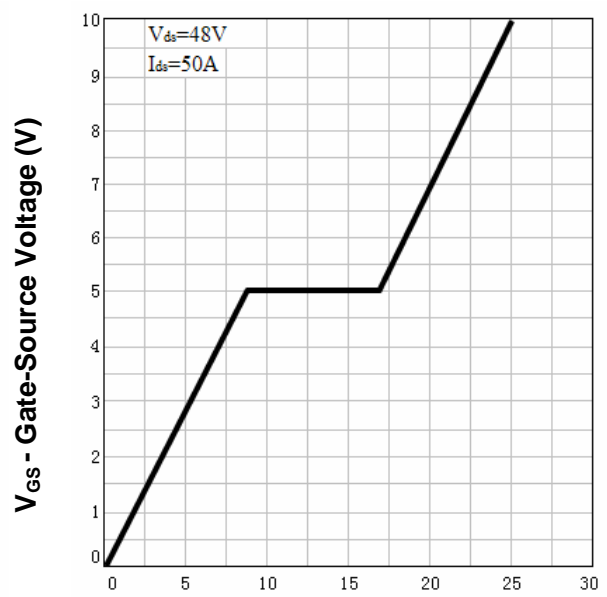

Q_G - Gate Charge (nC)

Avalanche Test Circuit and Waveforms

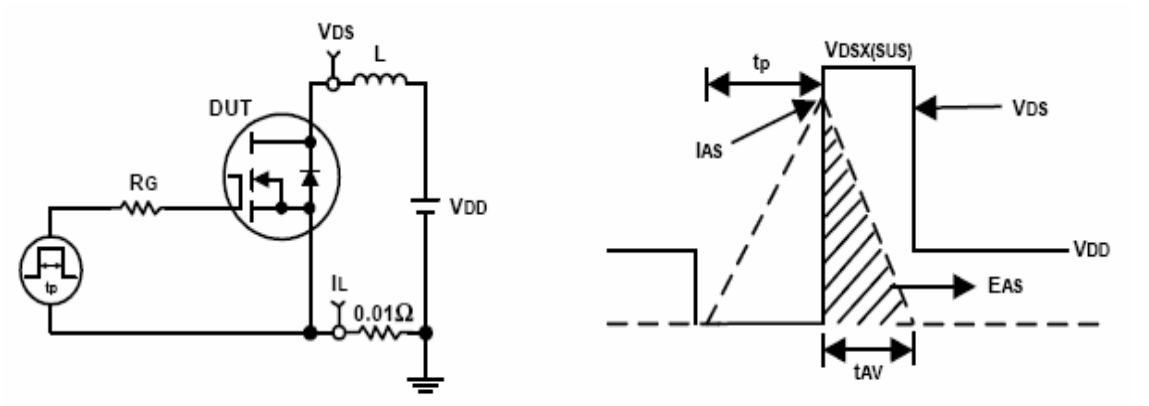

Switching Time Test Circuit and Waveforms

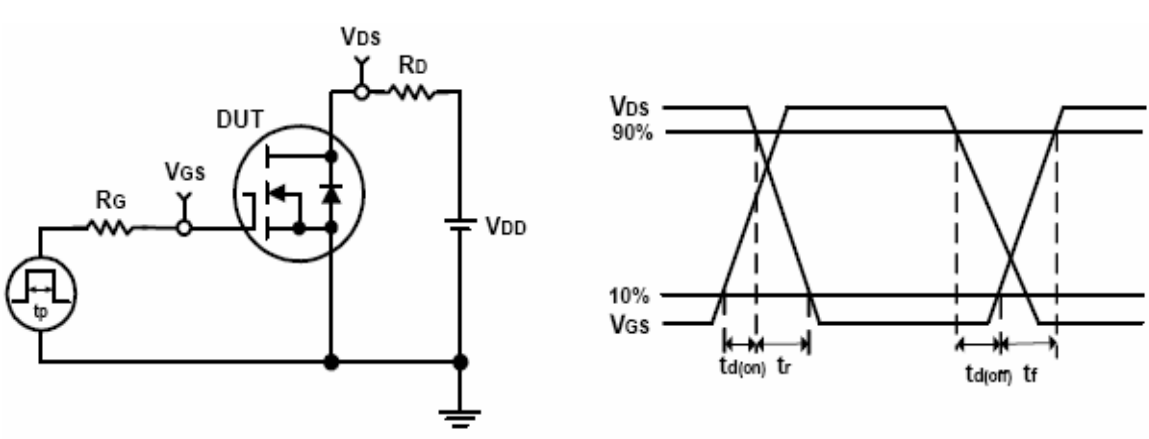

Ordering and Marking Information

| Device | Marking | Package | Packaging | Quantity | Reel Size | Tape width |
|---------------|----------------|----------------|------------------|-----------------|------------------|-------------------|
| RU6050R | RU6050R | TO-220 | Tube | 50 | - | - |

Package Information

TO-220FB-3L



| SYMBOL | MM | | | INCH | | | SYMBOL | MM | | | INCH | | |
|--------|-------|-------|-------|-------|-------|-------|------------|----------|------|-------|-----------|-------|-------|
| | MIN | NOM | MAX | MIN | NOM | MAX | | MIN | NOM | MAX | MIN | NOM | MAX |
| A | 4.40 | 4.57 | 4.70 | 0.173 | 0.180 | 0.185 | $\phi p1$ | 1.40 | 1.50 | 1.60 | 0.055 | 0.059 | 0.063 |
| A1 | 1.27 | 1.30 | 1.33 | 0.050 | 0.051 | 0.052 | e | 2.54BSC | | | 0.1BSC | | |
| A2 | 2.35 | 2.40 | 2.50 | 0.093 | 0.094 | 0.098 | e1 | 5.08BSC | | | 0.2BSC | | |
| b | 0.77 | - | 0.90 | 0.030 | - | 0.035 | H1 | 6.40 | 6.50 | 6.60 | 0.252 | 0.256 | 0.260 |
| b2 | 1.23 | - | 1.36 | 0.048 | - | 0.054 | L | 12.75 | - | 13.17 | 0.502 | - | 0.519 |
| C | 0.48 | 0.50 | 0.52 | 0.019 | 0.020 | 0.021 | L1 | - | - | 3.95 | - | - | 0.156 |
| D | 15.40 | 15.60 | 15.80 | 0.606 | 0.614 | 0.622 | L2 | 2.50REF. | | | 0.098REF. | | |
| D1 | 9.00 | 9.10 | 9.20 | 0.354 | 0.358 | 0.362 | ϕp | 3.57 | 3.60 | 3.63 | 0.141 | 0.142 | 0.143 |
| DEP | 0.05 | 0.10 | 0.20 | 0.002 | 0.004 | 0.008 | Q | 2.73 | 2.80 | 2.87 | 0.107 | 0.110 | 0.113 |
| E | 9.70 | 9.90 | 10.10 | 0.382 | 0.389 | 0.398 | $\theta 1$ | 5° | 7° | 9° | 5° | 7° | 9° |
| E1 | - | 8.70 | - | - | 0.343 | - | $\theta 2$ | 1° | 3° | 5° | 1° | 3° | 5° |
| E2 | 9.80 | 10.00 | 10.20 | 0.386 | 0.394 | 0.401 | | | | | | | |

ALL DIMENSIONS REFER TO JEDEC STANDARD
DO NOT INCLUDE MOLD FLASH OR PROTRUSIONS

Customer Service

Worldwide Sales and Service:

Sales@ruichips.com

Technical Support:

Technical@ruichips.com

Investor Relations Contacts:

Investor@ruichips.com

Marcom Contact:

Marcom@ruichips.com

Editorial Contact:

Editorial@ruichips.com

HR Contact:

HR@ruichips.com

Legal Contact:

Legal@ruichips.com

Shen Zhen RUICHIPS Semiconductor CO., LTD

Room 501, the 5floor An Tong Industrial Building,
NO.207 Mei Hua Road Fu Tian Area Shen Zhen City, CHINA

TEL: (86-755) 8311-5334

FAX: (86-755) 8311-4278

E-mail: Sales-SZ@ruichips.com