

10 9 8 7 6 5 4 3 2 73810

**NOTES:**

1. HOUSING MATERIAL: LIQUID CRYSTAL POLYMER (LCP), GLASS-FILLED, UL94V-0, COLOR: BLACK PS-73670-9999.
2. THIS PART CONFORMS TO MOLEX PRODUCT SPECIFICATION SD-73802-001 FOR DIMENSIONAL INFORMATION.
3. SEE DRAWINGS SD-73800-001, SD-73801-001, AND SD-73802-001 FOR DIMENSIONAL INFORMATION.
4. DIMENSIONS ARE IN MILLIMETERS.
5. PARTS MARKED WITH PART NUMBER AND DATE CODE.

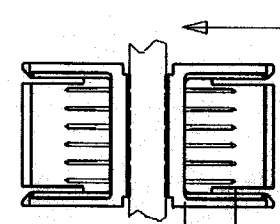
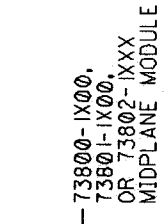
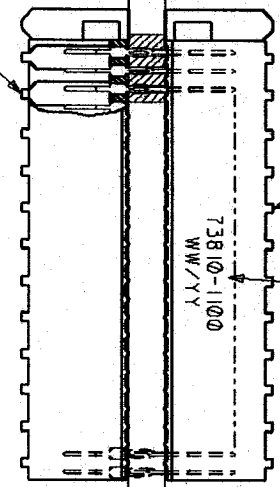
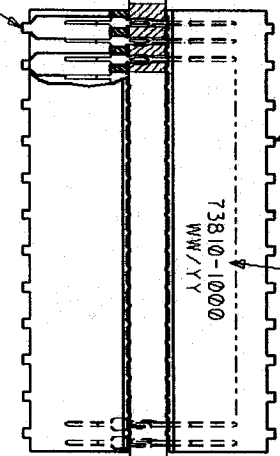
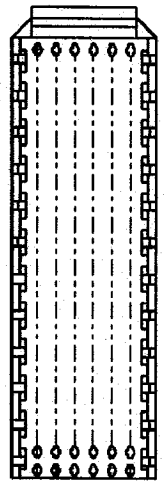
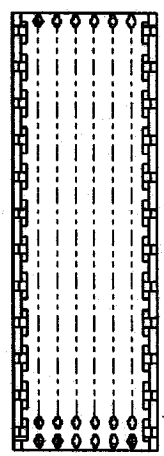

REVISIONS	DATE	BY	DESCRIPTION
2		B	REVISED
1		B	CHK. SPEED 99/11/00
			APP. CBIXLER 99/11/00

QUALITY SYMBOLS	DESCRIPTION
MAJOR	△
CRITICAL	▽
C/0	▽

GENERAL TOLERANCES (UNLESS SPECIFIED)	SCALE	DESIGN UNITS	THIRD ANGLE PROJECTION	TITLES
4 PLACES ±0.1	2 : 1	MM	AS SHOWN	SALES ASSEMBLY, HDM
3 PLACES ±0.2				DOUBLE-END MIDPLANE, 144 POS.
2 PLACES ±0.05				SLIDE-ON HOUSING
1 PLACE ±0.10				
ANGULAR: ± 1/2				

DRAWN BY & DATE	CHECKED BY & DATE	APPROVED BY & DATE	CAD FILENAME	MATERIAL NO.	DRAWING NO.	SHEET NO.
UBINGHAM 97/06/19	SPEED 97/06/19	CBIXLER 97/06/19	573810X.LDGN	SD-73810-001	10F 2	1 OF 2

INCORPORATED AND SHOULD NOT BE USED WITHOUT WRITTEN PERMISSION.	INCORPORATED AND SHOULD NOT BE USED WITHOUT WRITTEN PERMISSION.
---	---



# MATERIAL NUMBER ASSIGNMENT

73810-\*\*\*

I = 144-CIRCUIT  
 Ø = OPEN END VERSION  
 I = CLOSED END VERSION  
 2 = POLAR/GUIDE VERSION

73800-1X00,  
 73801-1X00,  
 OR 73802-1XXX  
 MIDPLANE MODULE

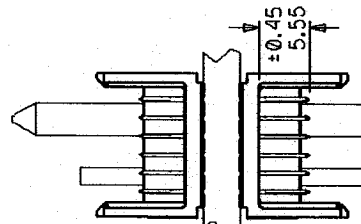
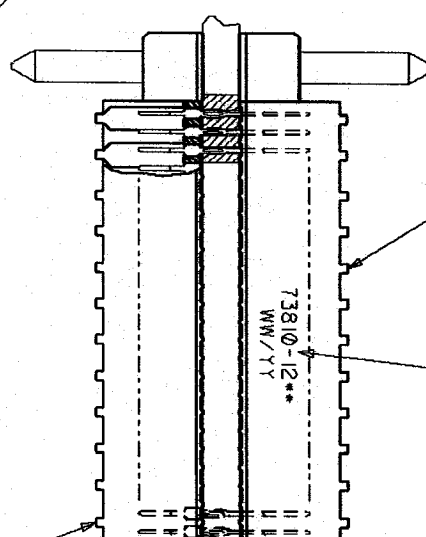
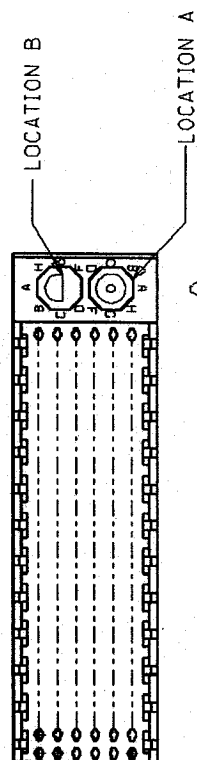

SEE NOTE 5

NUMBER	GUIDE POST LOCATION	POLAR KEY POSITION
Ø0	N/A	N/A
Ø1	B	A
Ø2	A	
Ø3	A	B
Ø4	B	
Ø5	B	C
Ø6	A	
Ø7	B	D
Ø8	A	
Ø9	B	E
Ø10	A	
Ø11	B	F
Ø12	A	
Ø13	B	G
Ø14	A	
Ø15	B	H
Ø16	A	
Ø17	B	N/A
Ø18	A	

QUALITY SYMBOLS MAJOR: Ø CRITICAL: ▽ C/Ø		GENERAL TOLERANCES (UNLESS SPECIFIED) 4 PLACES ±0. 3 PLACES ±0. 2 PLACES ±0.05 1 PLACE ±0.10 ANGULAR: ± 1/2° DRAFT WHERE APPLICABLE MUST REMAIN WITHIN DIMENSIONS		SCALE: DESIGN UNITS 2:1 DRAWN BY & DATE: JBINGHAM 9/7/06/19 CHECKED BY & DATE: SREED 9/7/06/19 APPROVED BY & DATE: CBIXLER 9/7/06/19 CAD FILENAME: S73810X2.DGN MATERIAL NO.: SD-73810-001 DRAWING NO.: SEE CHART		DIMENSIONS: DIM INCH DIM MM THIRD ANGLE PROJECTION DIM INCH DIM MM		SHEET REV 2 REVISE ON CAD ONLY	
DESCRIPTION 73810-12XX POLAR/GUIDE HOUSING		TITLE: SALES ASSEMBLY, HDM DOUBLE-END MIDPLANE, 144 POS. SLIDE-ON HOUSING		MOLEX INCORPORATED		SHEET NO. 2		SIZE B	