

SKiiP 23AC126V1



MiniSKiiP[®]2

3-phase bridge inverter

SKiiP 23AC126V1

Preliminary Data

Features

- Fast Trench IGBTs
- Robust and soft freewheeling diodes in CAL technology
- Highly reliable spring contacts for electrical connections
- UL recognised file no. E63532

Typical Applications

- Inverter up to 16 kVA
- Typical motor power 7,5 kW

Remarks

- V_{CEsat} , V_F = chip level value

Absolute Maximum Ratings		$T_S = 25\text{ °C}$, unless otherwise specified	
Symbol	Conditions	Values	Units
IGBT - Inverter			
V_{CES}	$T_S = 25\text{ (70) °C}$ $t_p \leq 1\text{ ms}$	1200	V
I_C		41 (31)	A
I_{CRM}		50	A
V_{GES}		± 20	V
T_j		-40...+150	°C
Diode - Inverter			
I_F	$T_S = 25\text{ (70) °C}$ $t_p \leq 1\text{ ms}$	30 (22)	A
I_{FRM}		50	A
T_j		-40...+150	°C
I_{tRMS}	per power terminal (20 A / spring)	100	A
T_{stg}	$T_{op} \leq T_{stg}$	-40...+125	°C
V_{isol}	AC, 1 min.	2500	V

Characteristics		$T_S = 25\text{ °C}$, unless otherwise specified			
Symbol	Conditions	min.	typ.	max.	Units
IGBT - Inverter					
V_{CEsat}	$I_{Cnom} = 25\text{ A}$, $T_j = 25\text{ (125) °C}$		1,7 (2)	2,1 (2,4)	V
$V_{GE(th)}$	$V_{GE} = V_{CE}$, $I_C = 1\text{ mA}$	5	5,8	6,5	V
$V_{CE(TO)}$	$T_j = 25\text{ (125) °C}$		1 (0,9)	1,2 (1,1)	V
r_T	$T_j = 25\text{ (125) °C}$		28 (44)	36 (52)	mΩ
C_{ies}	$V_{CE} = 25\text{ V}$, $V_{GE} = 0\text{ V}$, $f = 1\text{ MHz}$		1,8		nF
C_{oes}	$V_{CE} = 25\text{ V}$, $V_{GE} = 0\text{ V}$, $f = 1\text{ MHz}$		0,3		nF
C_{res}	$V_{CE} = 25\text{ V}$, $V_{GE} = 0\text{ V}$, $f = 1\text{ MHz}$		0,2		nF
$R_{th(j-s)}$	per IGBT		0,9		K/W
$t_{d(on)}$	under following conditions		80		ns
t_r	$V_{CC} = 600\text{ V}$, $V_{GE} = \pm 15\text{ V}$		30		ns
$t_{d(off)}$	$I_{Cnom} = 25\text{ A}$, $T_j = 125\text{ °C}$		480		ns
t_f	$R_{Gon} = R_{Goff} = 30\text{ Ω}$		85		ns
E_{on}	inductive load		3,7		mJ
E_{off}			3,1		mJ
Diode - Inverter					
$V_F = V_{EC}$	$I_{Fnom} = 25\text{ A}$, $T_j = 25\text{ (125) °C}$		1,8 (1,8)	2,1 (2,2)	V
$V_{(TO)}$	$T_j = 25\text{ (125) °C}$		1 (0,8)	1,1 (0,9)	V
r_T	$T_j = 25\text{ (125) °C}$		32 (40)	40 (52)	mΩ
$R_{th(j-s)}$	per diode		1,7		K/W
I_{RRM}	under following conditions		35		A
Q_{rr}	$I_{Fnom} = 25\text{ A}$, $V_R = 600\text{ V}$		6		μC
E_{rr}	$V_{GE} = 0\text{ V}$, $T_j = 125\text{ °C}$ $di_F/dt = 1000\text{ A/μs}$		2,6		mJ
Temperature Sensor					
R_{ts}	3 %, $T_r = 25\text{ (100) °C}$		1000(1670)		Ω
Mechanical Data					
m			65		g
M_s	Mounting torque	2		2,5	Nm

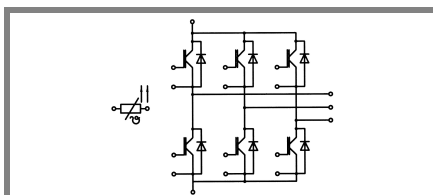

AC

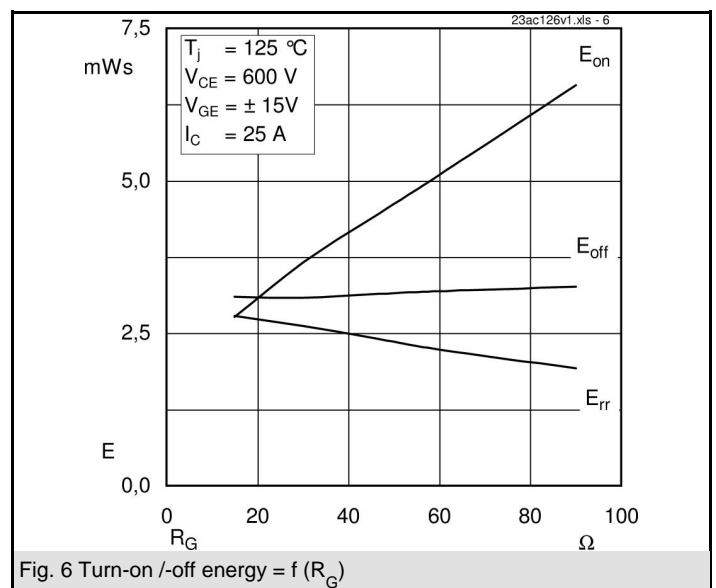
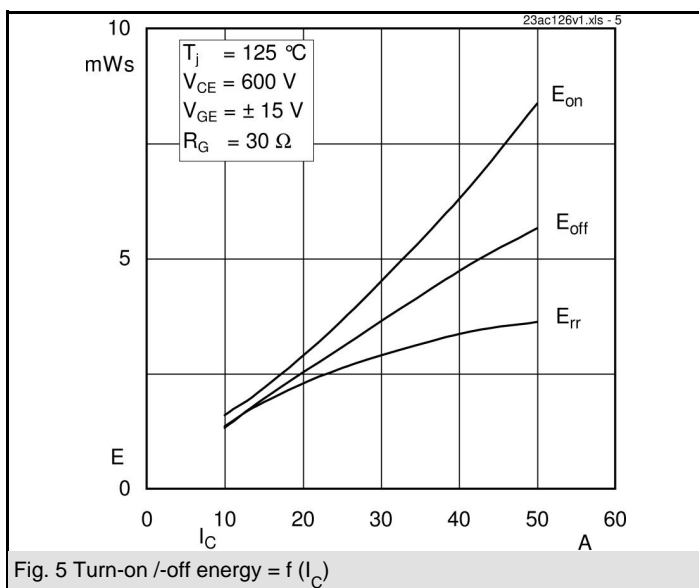
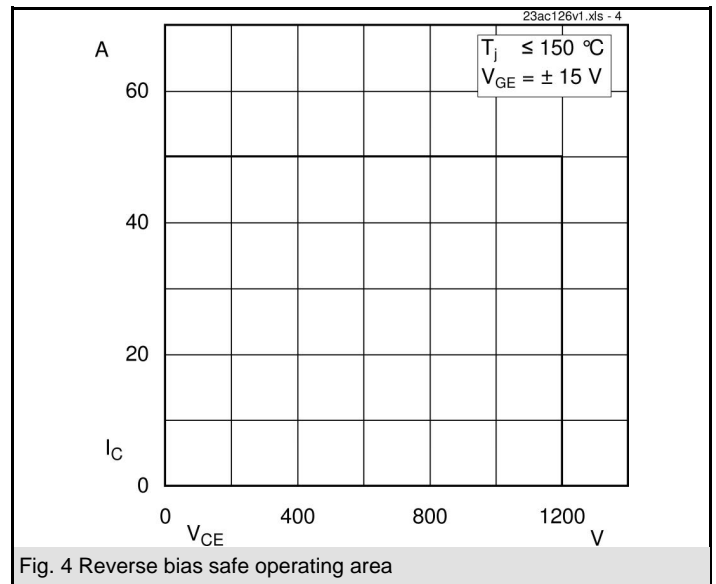
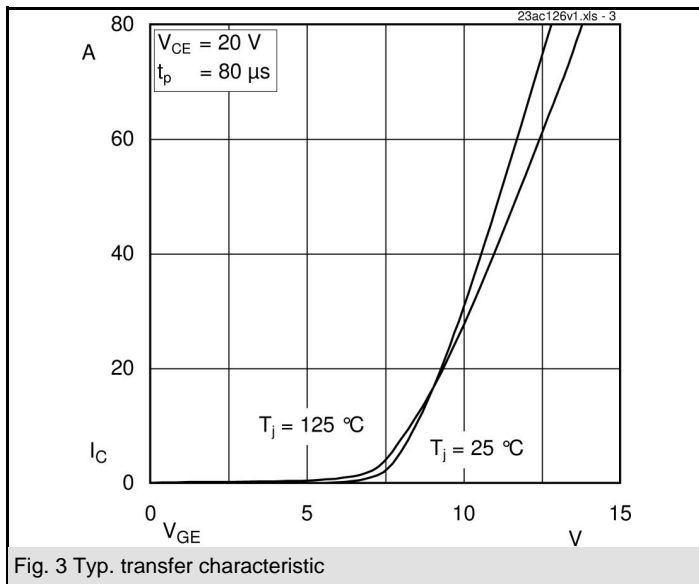
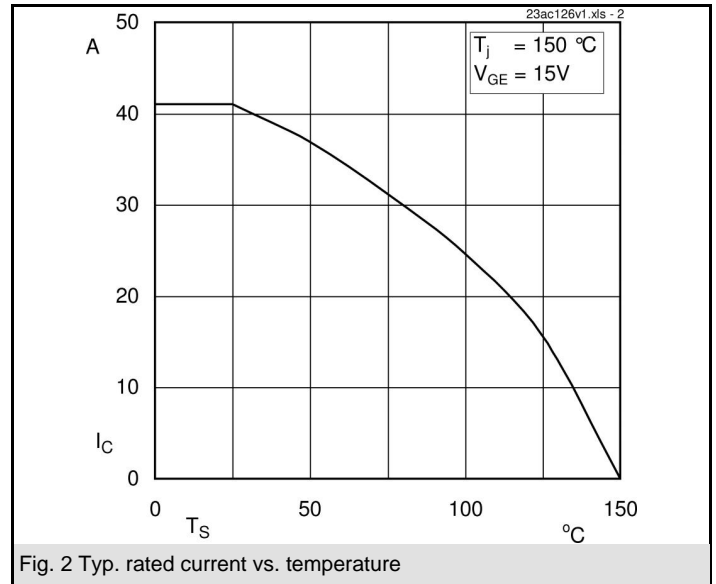
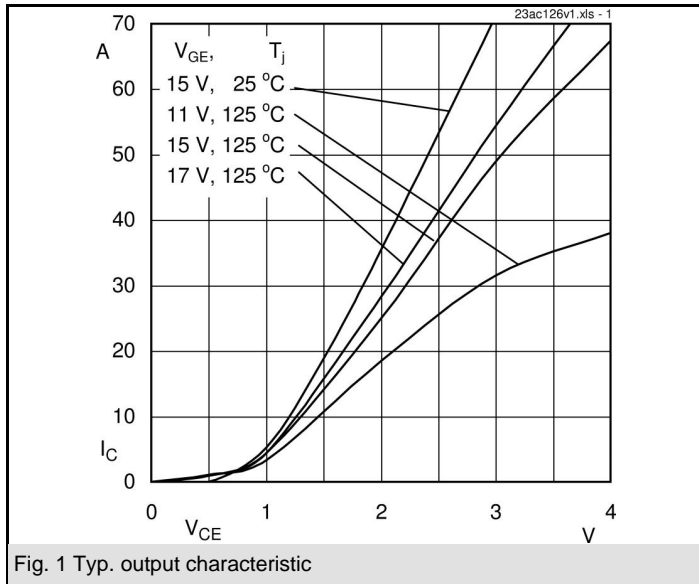

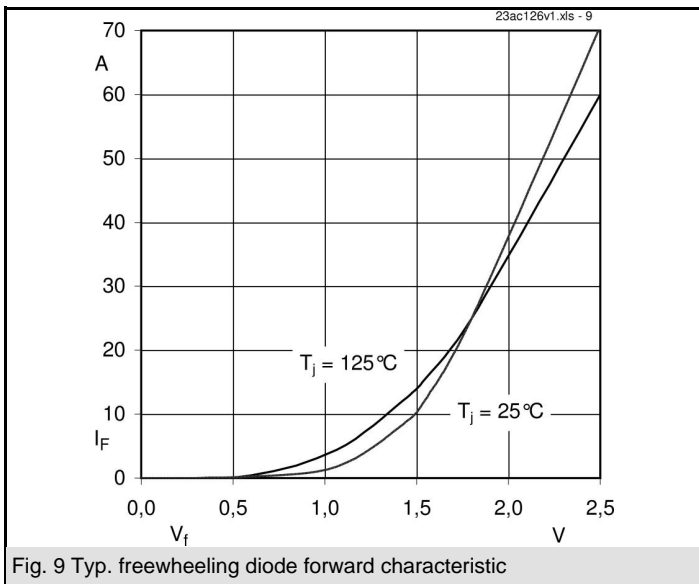
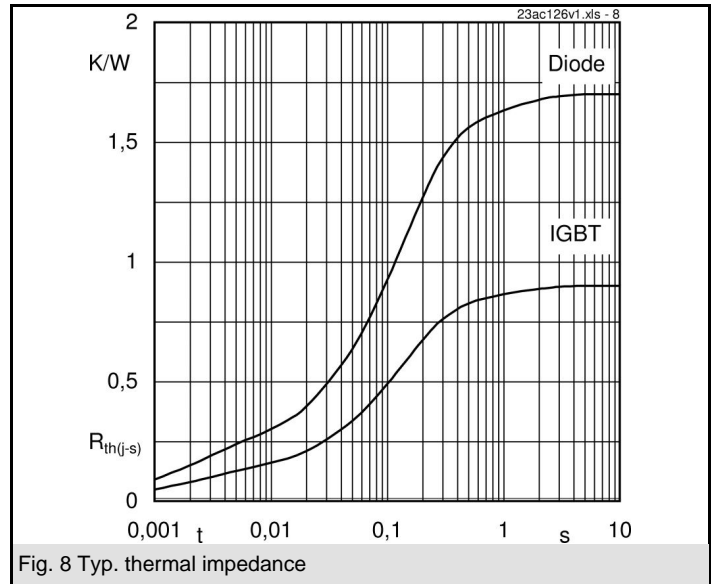
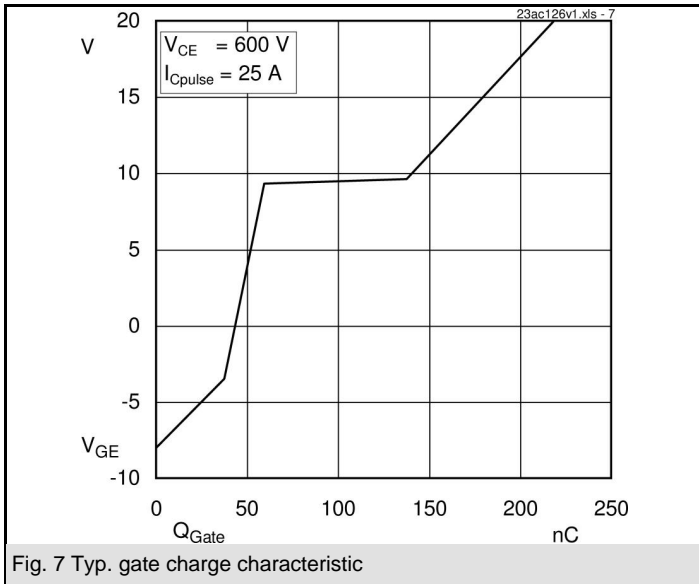

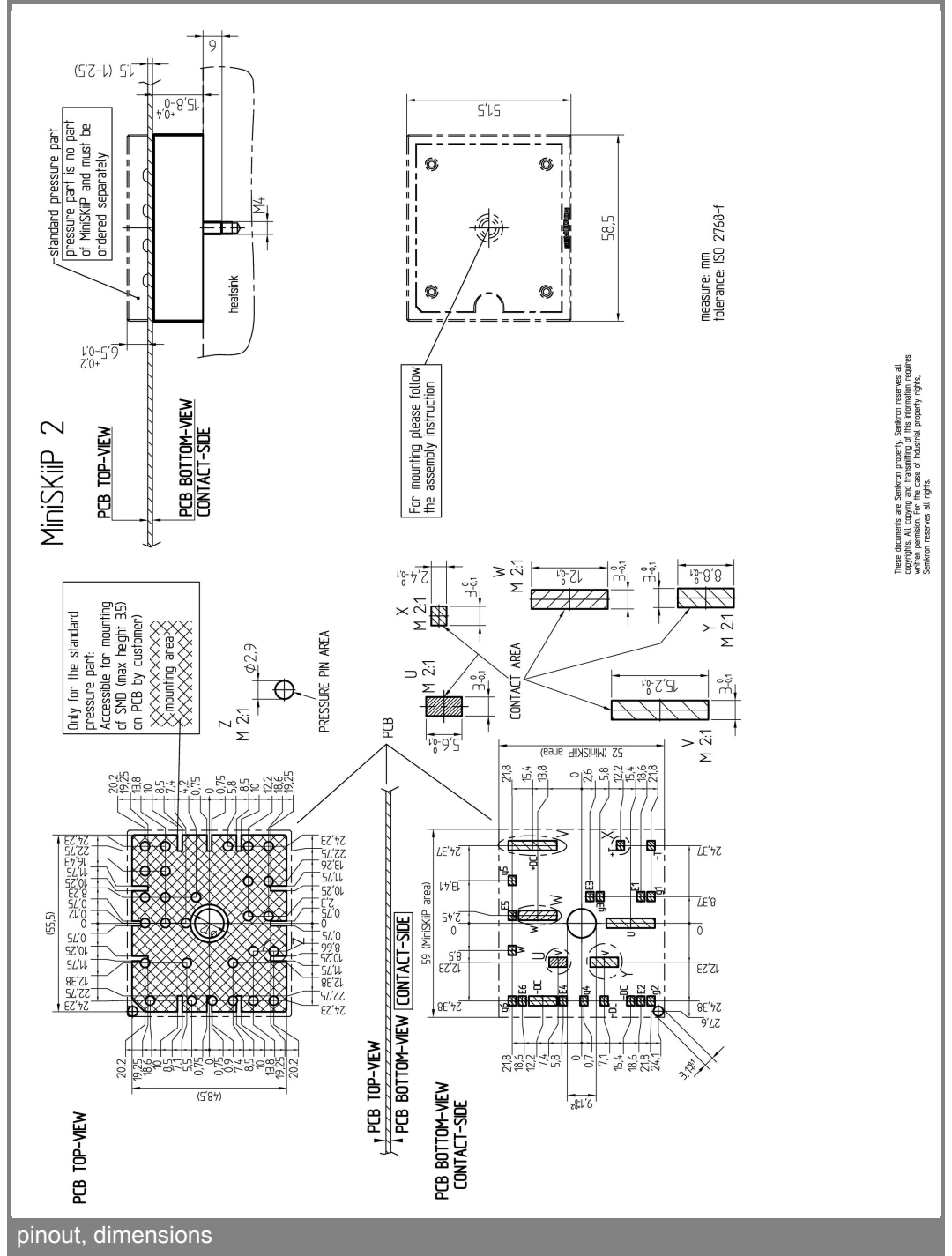
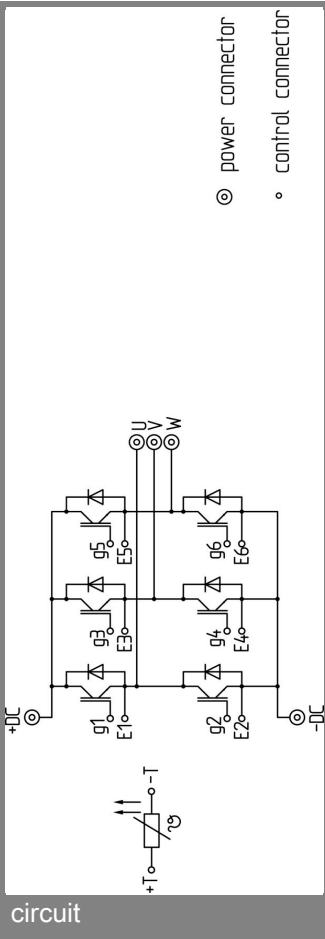

These documents are Semikron property. Semikron reserves all copyrights. All copies and transmitting of the information requires written permission. In the case of industrial property rights, Semikron reserves all rights.

This is an electrostatic discharge sensitive device (ESDS), international standard IEC 60747-1, Chapter IX.

This technical information specifies semiconductor devices but promises no characteristics. No warranty or guarantee expressed or implied is made regarding delivery, performance or suitability.