

## Notice for TAIYO YUDEN products

---

Please read this notice before using the TAIYO YUDEN products.

### REMINDERS

- Product information in this catalog is as of October 2012. All of the contents specified herein are subject to change without notice due to technical improvements, etc. Therefore, please check for the latest information carefully before practical application or usage of the Products.

Please note that Taiyo Yuden Co., Ltd. shall not be responsible for any defects in products or equipment incorporating such products, which are caused under the conditions other than those specified in this catalog or individual specification.

- Please contact Taiyo Yuden Co., Ltd. for further details of product specifications as the individual specification is available.
- Please conduct validation and verification of products in actual condition of mounting and operating environment before commercial shipment of the equipment.
- All electronic components or functional modules listed in this catalog are developed, designed and intended for use in general electronics equipment.(for AV, office automation, household, office supply, information service, telecommunications, (such as mobile phone or PC) etc.). Before incorporating the components or devices into any equipment in the field such as transportation,( automotive control, train control, ship control), transportation signal, disaster prevention, medical, public information network (telephone exchange, base station) etc. which may have direct influence to harm or injure a human body, please contact Taiyo Yuden Co., Ltd. for more detail in advance. Do not incorporate the products into any equipment in fields such as aerospace, aviation, nuclear control, submarine system, military, etc. where higher safety and reliability are especially required.

In addition, even electronic components or functional modules that are used for the general electronic equipment, if the equipment or the electric circuit require high safety or reliability function or performances, a sufficient reliability evaluation check for safety shall be performed before commercial shipment and moreover, due consideration to install a protective circuit is strongly recommended at customer's design stage.

- The contents of this catalog are applicable to the products which are purchased from our sales offices or distributors (so called "TAIYO YUDEN' s official sales channel").  
It is only applicable to the products purchased from any of TAIYO YUDEN' s official sales channel.
- Please note that Taiyo Yuden Co., Ltd. shall have no responsibility for any controversies or disputes that may occur in connection with a third party's intellectual property rights and other related rights arising from your usage of products in this catalog. Taiyo Yuden Co., Ltd. grants no license for such rights.

#### ■ Caution for export

Certain items in this catalog may require specific procedures for export according to "Foreign Exchange and Foreign Trade Control Law" of Japan, "U.S. Export Administration Regulations", and other applicable regulations. Should you have any question or inquiry on this matter, please contact our sales staff.

# MULTILAYER CERAMIC CAPACITORS



WAVE

REFLOW

## PARTS NUMBER

J	M	K	3	1	6	△	B	J	1	0	6	M	L	-	T	△
①	②	③	④	⑤	⑥	⑦	⑧	⑨	⑩	⑪	⑫					

△=Blank space

### ① Rated voltage

Code	Rated voltage [VDC]
P	2.5
A	4
J	6.3
L	10
E	16
T	25
G	35
U	50
H	100
Q	250
S	630

### ③ End termination

Code	End termination
K	Plated
R	High Reliability Application

### ② Series name

Code	Series name
M	Multilayer ceramic capacitor
V	Multilayer ceramic capacitor for high frequency
W	LW reverse type multilayer capacitor

### ④ Dimension (L × W)

Type	Dimensions (L × W) [mm]	EIA (inch)
042	0.4 × 0.2	01005
063	0.6 × 0.3	0201
105	1.0 × 0.5	0402
	0.52 × 1.0 ※	0204
107	1.6 × 0.8	0603
	0.8 × 1.6 ※	0306
212	2.0 × 1.25	0805
	1.25 × 2.0 ※	0508
316	3.2 × 1.6	1206
325	3.2 × 2.5	1210
432	4.5 × 3.2	1812

Note : ※LW reverse type (□WK) only

### ⑤ Dimension tolerance

Code	Type	L [mm]	W [mm]	T [mm]	
△	ALL	Standard	Standard	Standard	
	063	0.6 ± 0.05	0.3 ± 0.05	0.3 ± 0.05	
	105	1.0 ± 0.10	0.5 ± 0.10	0.5 ± 0.10	
	107	1.6 + 0.15 / - 0.05	0.8 + 0.15 / - 0.05	0.8 + 0.15 / - 0.05	
A	212	2.0 + 0.15 / - 0.05	1.25 + 0.15 / - 0.05	0.45 ± 0.05 0.85 ± 0.10 1.25 + 0.15 / - 0.05	
	316	3.2 ± 0.20	1.25 ± 0.20	0.85 ± 0.10 1.6 ± 0.20	
	325	3.2 ± 0.30	2.5 ± 0.30	2.5 ± 0.30	
	B	105	1.0 + 0.15 / - 0.05	0.5 + 0.15 / - 0.05	0.5 + 0.15 / - 0.05 0.45 ± 0.05 0.8 + 0.20 / - 0
		107	1.6 + 0.20 / - 0	0.8 + 0.20 / - 0	0.85 ± 0.10 1.25 + 0.20 / - 0
212		2.0 + 0.20 / - 0	1.25 + 0.20 / - 0	1.6 ± 0.30	
C	316	3.2 ± 0.30	1.6 ± 0.30	1.6 ± 0.30	
	105	1.0 + 0.20 / - 0	0.5 + 0.20 / - 0	0.5 + 0.20 / - 0	

Note: P.6 Standard external dimensions

△= Blank space

### ⑥ Temperature characteristics code

■ High dielectric type (Excluding Super low distortion multilayer ceramic capacitor (FCAP™))

Code	Applicable standard		Temperature range [°C]	Ref. Temp. [°C]	Capacitance change	Capacitance tolerance	Tolerance code
BJ	JIS	B	-25 ~ + 85	20	± 10%	± 10%	K
	EIA	X5R	-55 ~ + 85	25	± 15%	± 20%	M
B7	EIA	X7R	-55 ~ + 125	25	± 15%	± 10%	K
						± 20%	M
C6	EIA	X6S	-55 ~ + 105	25	± 22%	± 10%	K
						± 20%	M
C7	EIA	X7S	-55 ~ + 125	25	± 22%	± 10%	K
						± 20%	M
LD(※)	EIA	X5R	-55 ~ + 85	25	± 15%	± 10%	K
						± 20%	M
△F	JIS	F	-25 ~ + 85	20	+30 / -80%	+80 / -20%	Z
	EIA	Y5V	-30 ~ + 85	25	+22 - 82%	+80 / -20%	Z

Note : ※LD Low distortion high value multilayer ceramic capacitor

△= Blank space

► This catalog contains the typical specification only due to the limitation of space. When you consider the purchase of our products, please check our specification. For details of each product (characteristics graph, reliability information, precautions for use, and so on), see our Web site (<http://www.ty-top.com/>).

■ Temperature compensating type

Code	Applicable standard		Temperature range [°C]	Ref. Temp. [°C]	Capacitance change	Capacitance tolerance	Tolerance code
CH	JIS	CH	-55 ~ +125	20	0 ± 60ppm/°C	±0.1pF	B
		C0H				±0.25pF	C
	EIA	±0.5pF		D			
		1pF		F			
		±5%		J			
±10%	K						
CJ	JIS	CJ	-55 ~ +125	20	0 ± 120ppm/°C	±0.25pF	C
	EIA	C0J		25			
CK	JIS	CK	-55 ~ +125	20	0 ± 250ppm/°C	±0.25pF	C
	EIA	C0K		25			
UJ	JIS	UJ	-55 ~ +125	20	-750 ± 120ppm/°C	±0.25pF	C
	EIA	U2J		25		±0.5pF	D
±5%			J				
UK	JIS	UK	-55 ~ +125	20	-750 ± 250ppm/°C	±0.5pF	C
	EIA	U2K	-55 ~ +125	25			
SL	JIS	S	-55 ~ +125	20	+350 ~ -1000ppm/°C	±5%	J

⑥ Series code

(Super low distortion multilayer ceramic capacitor (CFCAP™) only)

Code	Series code
SD	Standard

⑦ Nominal capacitance

Code (example)	Nominal capacitance
0R5	0.5pF
010	1pF
100	10pF
101	100p
102	1,000pF
103	10,000pF
104	0.1 μF
105	1.0 μF
106	10 μF
107	100 μF

Note : R=Decimal point

⑧ Capacitance tolerance

Code	Capacitance tolerance
B	±0.1pF
C	±0.25pF
D	±0.5pF
F	±1pF
J	±5%
K	±10%
M	±20%
Z	+80/-20%

⑨ Thickness

Code	Thickness [mm]
C	0.2
D	0.2(Temperature compensating of 042type)
P	0.3
T	
K	0.45
V	0.5
W	
A	0.8
D	0.85(212type or more)
F	1.15
G	1.25
L	1.6
N	1.9
Y	2.0 max
M	2.5

⑩ Special code

Code	Special code
-	Standard

⑪ Packaging

Code	Packaging
F	φ 178mm Taping (2mm pitch)
T	φ 178mm Taping (4mm pitch)
P	φ 178mm Taping (4mm pitch, 1000 pcs/reel) 325 type (Thickness code M)
W	φ 178mm Taping (1mm pitch) 042type only

⑫ Internal code

Code	Internal code
Δ	Standard

■ STANDARD EXTERNAL DIMENSIONS

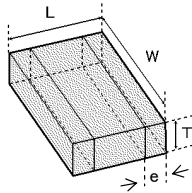
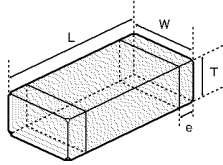

※ LW reverse type

Type( EIA )	Dimension [mm]				
	L	W	T	*1	e
□MK042(01005)	0.4±0.02	0.2±0.02	0.2±0.02	C D	0.1±0.03
□MK063(0201)	0.6±0.03	0.3±0.03	0.3±0.03	P T	0.15±0.05
□MK105(0402)	1.0±0.05	0.5±0.05	0.2±0.02	C	0.25±0.10
			0.3±0.03	P	
			0.5±0.05	V	
□VK105(0402)	1.0±0.05	0.5±0.05	0.5±0.05	W	0.25±0.10
□WK105(0204)※	0.52±0.05	1.0±0.05	0.3±0.05	P	0.18±0.08
□MK107(0603)	1.6±0.10	0.8±0.10	0.45±0.05	K	0.35±0.25
			0.8±0.10	A	
□MR107(0603)	1.6±0.10	0.8±0.10	0.8±0.10	A	0.1~0.6
□WK107(0306)※	0.8±0.10	1.6±0.10	0.5±0.05	V	0.25±0.15
□MK212(0805)	2.0±0.10	1.25±0.10	0.45±0.05	K	0.5±0.25
			0.85±0.10	D	
			1.25±0.10	G	
□MR212(0805)	2.0±0.10	1.25±0.10	1.25±0.10	G	0.25~0.75
□WK212(0508)※	1.25±0.15	2.0±0.15	0.85±0.1	D	0.3±0.2
□MK316(1206)	3.2±0.15	1.6±0.15	0.85±0.10	D	0.5+0.35/-0.25
			1.15±0.10	F	
			1.25±0.10	G	
			1.6±0.20	L	
□MR316(1206)	3.2±0.15	1.6±0.15	1.6±0.20	L	0.25~0.85
□MK325(1210)	3.2±0.30	2.5±0.20	0.85±0.10	D	0.6±0.3
			1.15±0.10	F	
			1.9±0.20	N	
			1.9+0.1/-0.2	Y	
			2.5±0.20	M	
□MR325(1210)	3.2±0.30	2.5±0.20	1.9±0.20	N	0.3~0.9
□MK432(1812)	4.5±0.40	3.2±0.30	2.5±0.20	M	0.9±0.6
			2.5±0.20	M	

Note : ※. LW reverse type, \*1.Thickness code

■ STANDARD QUANTITY

Type	EIA (inch)	Dimension		Standard quantity [pcs]	
		[mm]	Code	Paper tape	Embossed tape
042	01005	0.2	C	—	40000
			D		
063	0201	0.3	P	15000	—
			T		
105	0402	0.2	C	20000	—
			P		
		0.3	P	15000	—
			V		
0204 ※	0.30	P	10000	—	
		W			
107	0603	0.45	K	4000	—
			A		
		0306 ※	0.50	V	—
212	0805	0.45	K	4000	—
			D		
		0.85	G	—	3000
			D	4000	—
316	1206	0.85	D	4000	—
			F		
		1.15	F	—	3000
			G		
325	1210	1.6	L	—	2000
			D		
		0.85	D	—	2000
			F		
		1.9	N	—	2000
2.0 max	Y				
2.5	M				
432	1812	2.5	M	—	500(T), 1000(P)
			M	—	500

Note : ※.LW Reverse type(□WK)

▶ This catalog contains the typical specification only due to the limitation of space. When you consider the purchase of our products, please check our specification. For details of each product (characteristics graph, reliability information, precautions for use, and so on), see our Web site (<http://www.ty-top.com/>).

**Multilayer Ceramic Capacitors for High Frequency Applications (1GHz+)**

105TYPE

[Temperature Characteristic CH : CH/C0H] 0.5mm thickness (W)

Part number 1	Part number 2	Rated voltage [V]	Temperature characteristics	Capacitance [F]	Capacitance tolerance [%]	Q	HALT	Thickness*3 [mm]	Soldering R:Reflow W:Wave
							Rated voltage x %		
EVK105 CH0R3BW-F		16	CH C0H	0.3 p	±0.1pF	406	200	0.5±0.05	R
EVK105 CH0R4BW-F			CH C0H	0.4 p	±0.1pF	408	200	0.5±0.05	R
EVK105 CH0R5BW-F			CH C0H	0.5 p	±0.1pF	410	200	0.5±0.05	R
EVK105 CH0R6BW-F			CH C0H	0.6 p	±0.1pF	412	200	0.5±0.05	R
EVK105 CH0R7BW-F			CH C0H	0.7 p	±0.1pF	414	200	0.5±0.05	R
EVK105 CH0R8BW-F			CH C0H	0.8 p	±0.1pF	416	200	0.5±0.05	R
EVK105 CH0R9BW-F			CH C0H	0.9 p	±0.1pF	418	200	0.5±0.05	R
EVK105 CH010BW-F			CH C0H	1 p	±0.1pF	420	200	0.5±0.05	R
EVK105 CH1R1BW-F			CH C0H	1.1 p	±0.1pF	422	200	0.5±0.05	R
EVK105 CH1R2BW-F			CH C0H	1.2 p	±0.1pF	424	200	0.5±0.05	R
EVK105 CH1R3BW-F			CH C0H	1.3 p	±0.1pF	426	200	0.5±0.05	R
EVK105 CH1R5BW-F			CH C0H	1.5 p	±0.1pF	430	200	0.5±0.05	R
EVK105 CH1R6BW-F			CH C0H	1.6 p	±0.1pF	432	200	0.5±0.05	R
EVK105 CH1R8BW-F			CH C0H	1.8 p	±0.1pF	436	200	0.5±0.05	R
EVK105 CH020BW-F			CH C0H	2 p	±0.1pF	440	200	0.5±0.05	R
EVK105 CH2R2JW-F			CH C0H	2.2 p	±5%	444	200	0.5±0.05	R
EVK105 CH2R4JW-F			CH C0H	2.4 p	±5%	448	200	0.5±0.05	R
EVK105 CH2R7JW-F			CH C0H	2.7 p	±5%	454	200	0.5±0.05	R
EVK105 CH030JW-F			CH C0H	3 p	±5%	460	200	0.5±0.05	R
EVK105 CH3R3JW-F			CH C0H	3.3 p	±5%	466	200	0.5±0.05	R
EVK105 CH3R6JW-F			CH C0H	3.6 p	±5%	472	200	0.5±0.05	R
EVK105 CH3R9JW-F			CH C0H	3.9 p	±5%	478	200	0.5±0.05	R
EVK105 CH4R3JW-F			CH C0H	4.3 p	±5%	486	200	0.5±0.05	R
EVK105 CH4R7JW-F			CH C0H	4.7 p	±5%	494	200	0.5±0.05	R
EVK105 CH5R1JW-F		CH C0H	5.1 p	±5%	502	200	0.5±0.05	R	

[Temperature Characteristic RH : RH/R2H] 0.5mm thickness (W)

Part number 1	Part number 2	Rated voltage [V]	Temperature characteristics	Capacitance [F]	Capacitance tolerance [%]	Q	HALT	Thickness*3 [mm]	Soldering R:Reflow W:Wave
							Rated voltage x %		
EVK105 RH0R5BW-F		16	RH R2H	0.5 p	±0.1pF	410	200	0.5±0.05	R
EVK105 RH0R6BW-F			RH R2H	0.6 p	±0.1pF	412	200	0.5±0.05	R
EVK105 RH0R7BW-F			RH R2H	0.7 p	±0.1pF	414	200	0.5±0.05	R
EVK105 RH0R8BW-F			RH R2H	0.8 p	±0.1pF	416	200	0.5±0.05	R
EVK105 RH0R9BW-F			RH R2H	0.9 p	±0.1pF	418	200	0.5±0.05	R
EVK105 RH010BW-F			RH R2H	1 p	±0.1pF	420	200	0.5±0.05	R
EVK105 RH1R1BW-F			RH R2H	1.1 p	±0.1pF	422	200	0.5±0.05	R
EVK105 RH1R2BW-F			RH R2H	1.2 p	±0.1pF	424	200	0.5±0.05	R
EVK105 RH1R3BW-F			RH R2H	1.3 p	±0.1pF	426	200	0.5±0.05	R
EVK105 RH1R5BW-F			RH R2H	1.5 p	±0.1pF	430	200	0.5±0.05	R
EVK105 RH1R6BW-F			RH R2H	1.6 p	±0.1pF	432	200	0.5±0.05	R
EVK105 RH1R8BW-F			RH R2H	1.8 p	±0.1pF	436	200	0.5±0.05	R
EVK105 RH020BW-F			RH R2H	2 p	±0.1pF	440	200	0.5±0.05	R
EVK105 RH2R2JW-F			RH R2H	2.2 p	±5%	444	200	0.5±0.05	R
EVK105 RH2R4JW-F			RH R2H	2.4 p	±5%	448	200	0.5±0.05	R
EVK105 RH2R7JW-F			RH R2H	2.7 p	±5%	454	200	0.5±0.05	R
EVK105 RH030JW-F			RH R2H	3 p	±5%	460	200	0.5±0.05	R
EVK105 RH3R3JW-F			RH R2H	3.3 p	±5%	466	200	0.5±0.05	R
EVK105 RH3R6JW-F			RH R2H	3.6 p	±5%	472	200	0.5±0.05	R
EVK105 RH3R9JW-F			RH R2H	3.9 p	±5%	478	200	0.5±0.05	R
EVK105 RH4R3JW-F			RH R2H	4.3 p	±5%	486	200	0.5±0.05	R
EVK105 RH4R7JW-F			RH R2H	4.7 p	±5%	494	200	0.5±0.05	R
EVK105 RH5R1JW-F			RH R2H	5.1 p	±5%	502	200	0.5±0.05	R

[Temperature Characteristic CH : CH/C0H] 0.5mm thickness (W)

Part number 1	Part number 2	Rated voltage [V]	Temperature characteristics	Capacitance [F]	Capacitance tolerance [%]	Q	HALT	Thickness*3 [mm]	Soldering R:Reflow W:Wave
							Rated voltage x %		
UVK105 CH0R3BW-F		50	CH C0H	0.3 p	±0.1pF	406	200	0.5±0.05	R
UVK105 CH0R4BW-F			CH C0H	0.4 p	±0.1pF	408	200	0.5±0.05	R
UVK105 CH0R5BW-F			CH C0H	0.5 p	±0.1pF	410	200	0.5±0.05	R
UVK105 CH0R6BW-F			CH C0H	0.6 p	±0.1pF	412	200	0.5±0.05	R
UVK105 CH0R7BW-F			CH C0H	0.7 p	±0.1pF	414	200	0.5±0.05	R
UVK105 CH0R8BW-F			CH C0H	0.8 p	±0.1pF	416	200	0.5±0.05	R
UVK105 CH0R9BW-F			CH C0H	0.9 p	±0.1pF	418	200	0.5±0.05	R
UVK105 CH010BW-F			CH C0H	1 p	±0.1pF	420	200	0.5±0.05	R
UVK105 CH1R1BW-F			CH C0H	1.1 p	±0.1pF	422	200	0.5±0.05	R
UVK105 CH1R2BW-F			CH C0H	1.2 p	±0.1pF	424	200	0.5±0.05	R
UVK105 CH1R3BW-F			CH C0H	1.3 p	±0.1pF	426	200	0.5±0.05	R
UVK105 CH1R5BW-F			CH C0H	1.5 p	±0.1pF	430	200	0.5±0.05	R
UVK105 CH1R6BW-F			CH C0H	1.6 p	±0.1pF	432	200	0.5±0.05	R
UVK105 CH1R8BW-F			CH C0H	1.8 p	±0.1pF	436	200	0.5±0.05	R
UVK105 CH020BW-F			CH C0H	2 p	±0.1pF	440	200	0.5±0.05	R
UVK105 CH2R2JW-F			CH C0H	2.2 p	±5%	444	200	0.5±0.05	R
UVK105 CH2R4JW-F			CH C0H	2.4 p	±5%	448	200	0.5±0.05	R
UVK105 CH2R7JW-F			CH C0H	2.7 p	±5%	454	200	0.5±0.05	R
UVK105 CH030JW-F			CH C0H	3 p	±5%	460	200	0.5±0.05	R
UVK105 CH3R3JW-F			CH C0H	3.3 p	±5%	466	200	0.5±0.05	R
UVK105 CH3R6JW-F			CH C0H	3.6 p	±5%	472	200	0.5±0.05	R
UVK105 CH3R9JW-F			CH C0H	3.9 p	±5%	478	200	0.5±0.05	R
UVK105 CH4R3JW-F			CH C0H	4.3 p	±5%	486	200	0.5±0.05	R
UVK105 CH4R7JW-F			CH C0H	4.7 p	±5%	494	200	0.5±0.05	R
UVK105 CH5R1JW-F		CH C0H	5.1 p	±5%	502	200	0.5±0.05	R	

▶ This catalog contains the typical specification only due to the limitation of space. When you consider the purchase of our products, please check our specification. For details of each product (characteristics graph, reliability information, precautions for use, and so on), see our Web site (<http://www.ty-top.com/>).

[Temperature Characteristic RH : RH/R2H] 0.5mm thickness (W)

Part number 1	Part number 2	Rated voltage [V]	Temperature characteristics		Capacitance [F]	Capacitance tolerance [%]	Q	HALT	Thickness* <sup>3</sup> [mm]	Soldering R:Reflow W:Wave
								Rated voltage x %		
UVK105 RH0R5BW-F		50	RH	R2H	0.5 p	±0.1pF	410	200	0.5±0.05	R
UVK105 RH0R6BW-F			RH	R2H	0.6 p	±0.1pF	412	200	0.5±0.05	R
UVK105 RH0R7BW-F			RH	R2H	0.7 p	±0.1pF	414	200	0.5±0.05	R
UVK105 RH0R8BW-F			RH	R2H	0.8 p	±0.1pF	416	200	0.5±0.05	R
UVK105 RH0R9BW-F			RH	R2H	0.9 p	±0.1pF	418	200	0.5±0.05	R
UVK105 RH010BW-F			RH	R2H	1 p	±0.1pF	420	200	0.5±0.05	R
UVK105 RH1R1BW-F			RH	R2H	1.1 p	±0.1pF	422	200	0.5±0.05	R
UVK105 RH1R2BW-F			RH	R2H	1.2 p	±0.1pF	424	200	0.5±0.05	R
UVK105 RH1R3BW-F			RH	R2H	1.3 p	±0.1pF	426	200	0.5±0.05	R
UVK105 RH1R5BW-F			RH	R2H	1.5 p	±0.1pF	430	200	0.5±0.05	R
UVK105 RH1R6BW-F			RH	R2H	1.6 p	±0.1pF	432	200	0.5±0.05	R
UVK105 RH1R8BW-F			RH	R2H	1.8 p	±0.1pF	436	200	0.5±0.05	R
UVK105 RH020BW-F			RH	R2H	2 p	±0.1pF	440	200	0.5±0.05	R
UVK105 RH2R2JW-F			RH	R2H	2.2 p	±5%	444	200	0.5±0.05	R
UVK105 RH2R4JW-F			RH	R2H	2.4 p	±5%	448	200	0.5±0.05	R
UVK105 RH2R7JW-F			RH	R2H	2.7 p	±5%	454	200	0.5±0.05	R
UVK105 RH030JW-F			RH	R2H	3 p	±5%	460	200	0.5±0.05	R
UVK105 RH3R3JW-F			RH	R2H	3.3 p	±5%	466	200	0.5±0.05	R
UVK105 RH3R6JW-F			RH	R2H	3.6 p	±5%	472	200	0.5±0.05	R
UVK105 RH3R9JW-F			RH	R2H	3.9 p	±5%	478	200	0.5±0.05	R
UVK105 RH4R3JW-F		RH	R2H	4.3 p	±5%	486	200	0.5±0.05	R	
UVK105 RH4R7JW-F		RH	R2H	4.7 p	±5%	494	200	0.5±0.05	R	
UVK105 RH5R1JW-F		RH	R2H	5.1 p	±5%	502	200	0.5±0.05	R	

**Super Low Distortion Multilayer Ceramic Capacitors(GFCAP™)**

● 105TYPE

[Temperature Characteristic SD : Standard] 0.5mm thickness (V)

Part number 1	Part number 2	Rated voltage [V]	Temperature characteristics		Capacitance [F]	Capacitance tolerance [%]	tan δ [%]	HALT	Thickness* <sup>3</sup> [mm]	Soldering R:Reflow W:Wave
								Rated voltage x %		
UMK105 SD391KV-F		50	Standard Type	390 p	±10	0.1	200	0.5±0.05	R	
UMK105 SD471KV-F				470 p	±10	0.1	200	0.5±0.05	R	
UMK105 SD561KV-F				560 p	±10	0.1	200	0.5±0.05	R	
TMK105 SD681KV-F		25		680 p	±10	0.1	200	0.5±0.05	R	
TMK105 SD821KV-F				820 p	±10	0.1	200	0.5±0.05	R	
TMK105 SD102KV-F				1000 p	±10	0.1	200	0.5±0.05	R	
TMK105 SD122KV-F		16		1200 p	±10	0.1	200	0.5±0.05	R	
EMK105 SD152KV-F				1500 p	±10	0.1	200	0.5±0.05	R	
EMK105 SD182KV-F				1800 p	±10	0.1	200	0.5±0.05	R	
EMK105 SD222KV-F		10		2200 p	±10	0.1	200	0.5±0.05	R	
EMK105 SD272KV-F				2700 p	±10	0.1	200	0.5±0.05	R	
LMK105 SD332KV-F				3300 p	±10	0.1	200	0.5±0.05	R	
LMK105 SD392KV-F		10		3900 p	±10	0.1	200	0.5±0.05	R	
LMK105 SD472KV-F				4700 p	±10	0.1	200	0.5±0.05	R	

[Temperature Characteristic SD : Standard] 0.3mm thickness (P)

Part number 1	Part number 2	Rated voltage [V]	Temperature characteristics		Capacitance [F]	Capacitance tolerance [%]	tan δ [%]	HALT	Thickness* <sup>3</sup> [mm]	Soldering R:Reflow W:Wave
								Rated voltage x %		
LMK105 SD152KP-F		10	Standard Type	1500 p	±10	0.1	200	0.3±0.03	R	
JMK105 SD272KP-F		6.3		2700 p	±10	0.1	200	0.3±0.03	R	

● 107TYPE

[Temperature Characteristic SD : Standard] 0.8mm thickness (A)

Part number 1	Part number 2	Rated voltage [V]	Temperature characteristics		Capacitance [F]	Capacitance tolerance [%]	tan δ [%]	HALT	Thickness* <sup>3</sup> [mm]	Soldering R:Reflow W:Wave
								Rated voltage x %		
UMK107 SD102KA-T		50	Standard Type	1000 p	±10	0.1	200	0.8±0.10	R	
UMK107 SD122KA-T				1200 p	±10	0.1	200	0.8±0.10	R	
UMK107 SD152KA-T				1500 p	±10	0.1	200	0.8±0.10	R	
UMK107 SD182KA-T				1800 p	±10	0.1	200	0.8±0.10	R	
UMK107 SD222KA-T				25	2200 p	±10	0.1	200	0.8±0.10	R
UMK107 SD272KA-T					2700 p	±10	0.1	200	0.8±0.10	R
UMK107 SD332KA-T					3300 p	±10	0.1	200	0.8±0.10	R
TMK107 SD392KA-T				16	3900 p	±10	0.1	200	0.8±0.10	R
TMK107 SD472KA-T					4700 p	±10	0.1	200	0.8±0.10	R
EMK107 SD562KA-T					5600 p	±10	0.1	200	0.8±0.10	R
EMK107 SD682KA-T		10		6800 p	±10	0.1	200	0.8±0.10	R	
EMK107 SD822KA-T				8200 p	±10	0.1	200	0.8±0.10	R	
EMK107 SD103KA-T				10000 p	±10	0.1	200	0.8±0.10	R	
LMK107 SD123KA-T		10		12000 p	±10	0.1	200	0.8±0.10	R	
LMK107 SD153KA-T				15000 p	±10	0.1	200	0.8±0.10	R	
LMK107 SD183KA-T				18000 p	±10	0.1	200	0.8±0.10	R	
LMK107 SD223KA-T				22000 p	±10	0.1	200	0.8±0.10	R	

● 212TYPE

[Temperature Characteristic SD : Standard] 1.25mm thickness (G)

Part number 1	Part number 2	Rated voltage [V]	Temperature characteristics		Capacitance [F]	Capacitance tolerance [%]	tan δ [%]	HALT	Thickness* <sup>3</sup> [mm]	Soldering R:Reflow W:Wave
								Rated voltage x %		
GMK212 SD183KG-T		35	Standard Type	18000 p	±10	0.1	200	1.25±0.10	R	
GMK212 SD223KG-T				22000 p	±10	0.1	200	1.25±0.10	R	
GMK212 SD273KG-T				27000 p	±10	0.1	200	1.25±0.10	R	
LMK212 SD683KG-T		10		68000 p	±10	0.1	200	1.25±0.10	R	
LMK212 SD823KG-T				82000 p	±10	0.1	200	1.25±0.10	R	
LMK212 SD104KG-T				0.1 μ	±10	0.1	200	1.25±0.10	R	

▶ This catalog contains the typical specification only due to the limitation of space. When you consider the purchase of our products, please check our specification. For details of each product (characteristics graph, reliability information, precautions for use, and so on), see our Web site (<http://www.ty-top.com/>).

# Multilayer Ceramic Capacitors

## PACKAGING

### ① Minimum Quantity

#### ● Taped package

Type(EIA)	Thickness		Standard quantity [pcs]	
	mm	code	Paper tape	Embossed tape
□MK042(01005)	0.2	C, D	—	40000
□MK063(0201)	0.3	P, T	15000	
□WK105(0204) ※	0.3	P	10000	
□MK105(0402)	0.2	C	20000	—
	0.3	P	15000	
	0.5	V	10000	
□VK105(0402) ※	0.5	W	4000	
□MK107(0603)	0.45	K	—	4000
□WK107(0306) ※	0.5	V	—	4000
□MR107(0603)	0.8	A	—	—
□MK212(0805)	0.45	K	4000	—
□WK212(0508) ※	0.85	D	—	3000
□MR212(0805)	1.25	G	—	—
□MK316(1206) □MR316(1206)	0.85	D	4000	—
	1.15	F	—	3000
	1.25	G	—	—
□MK325(1210) □MR325(1210)	1.6	L	—	2000
	0.85	D	—	—
	1.15	F	—	—
	1.9	N	—	—
□MK432(1812)	2.0max.	Y	—	500(T), 1000(P)
	2.5	M	—	500

Note : ※ LW Reverse type.

### ② Taping material

※No bottom tape for pressed carrier tape

#### ● Card board carrier tape

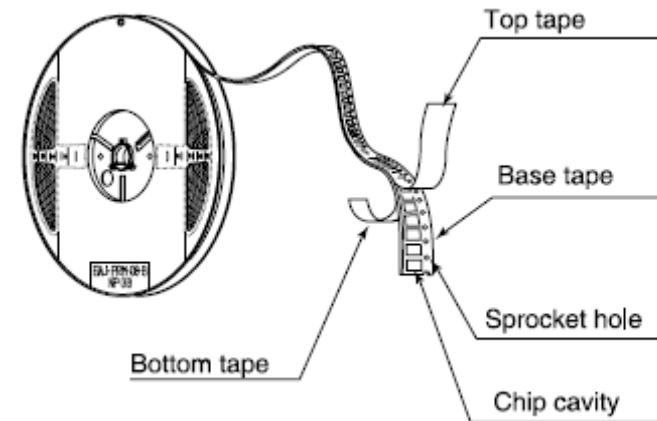

#### ● Embossed tape

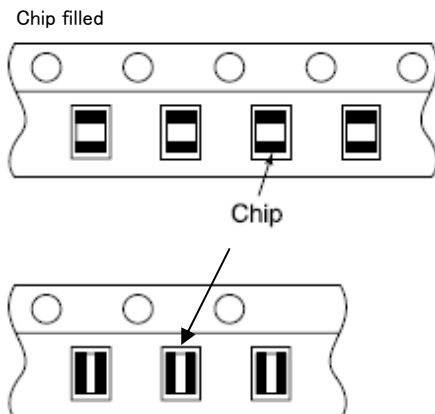
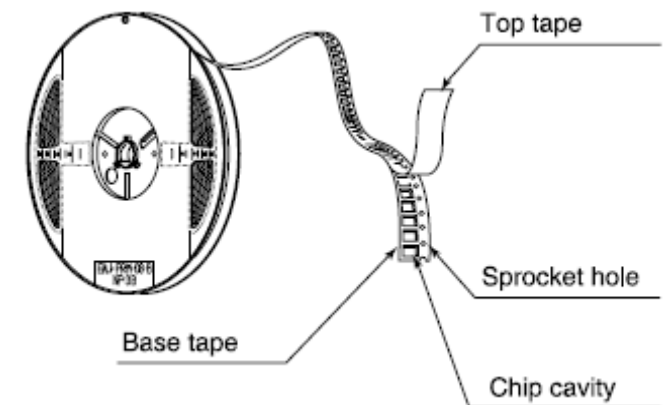

▶ This catalog contains the typical specification only due to the limitation of space. When you consider the purchase of our products, please check our specification. For details of each product (characteristics graph, reliability information, precautions for use, and so on), see our Web site (<http://www.ty-top.com/>).

### ③ Representative taping dimensions

- Paper Tape (8mm wide)
- Pressed carrier tape ( 2mm pitch)

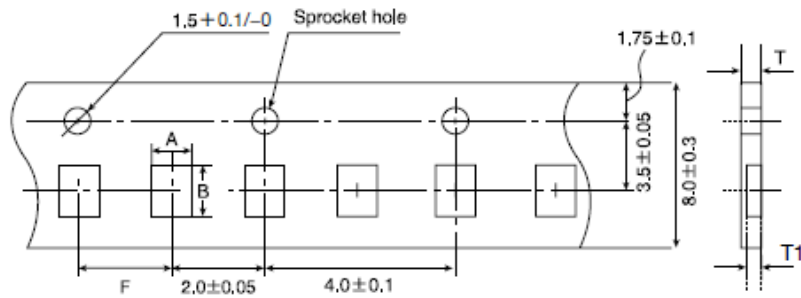

Type(EIA)	Chip Cavity		Insertion Pitch F	Tape Thickness	
	A	B		T	T1
□MK063(0201)	0.37	0.67	2.0±0.05	0.45max.	0.42max.
□WK105(0204) ※	0.65	1.15		0.4max.	0.3max.
□MK105(0402) (*1 C)				0.45max.	0.42max.
□MK105(0402) (*1 P)					

Note \*1 Thickness, C: 0.2mm ,P: 0.3mm. ※ LW Reverse type.

Unit: mm

- Punched carrier tape (2mm pitch)

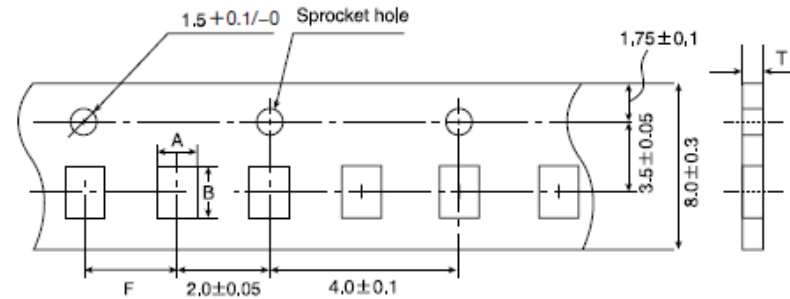

Type(EIA)	Chip Cavity		Insertion Pitch F	Tape Thickness
	A	B		T
□MK105 (0402)	0.65	1.15	2.0±0.05	0.8max.
□VK105 (0402)				

Unit: mm

- Punched carrier tape (4mm pitch)

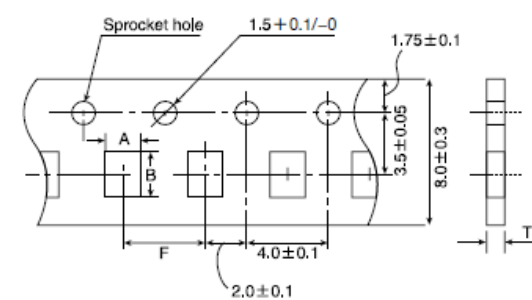

Type(EIA)	Chip Cavity		Insertion Pitch F	Tape Thickness
	A	B		T
□MK107(0603)	1.0	1.8	4.0±0.1	1.1max.
□WK107(0306) ※				
□MR107(0603)				
□MK212(0805)	1.65	2.4		1.1max.
□WK212(0508) ※				
□MK316(1206)	2.0	3.6		

Note: Taping size might be different depending on the size of the product. ※ LW Reverse type.

Unit: mm



● Embossed tape (4mm wide)

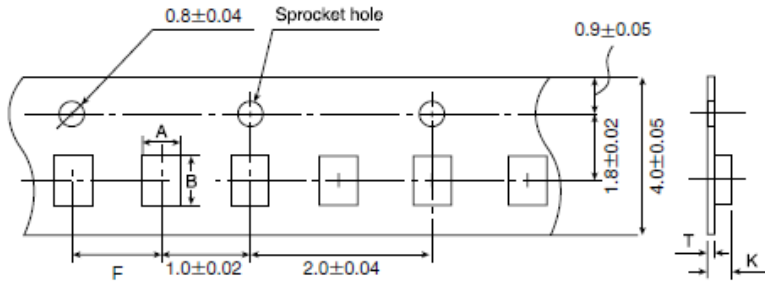

Type(EIA)	Chip Cavity		Insertion Pitch	Tape Thickness	
	A	B		K	T
□MK042(01005)	0.23	0.43	1.0±0.02	0.5max.	0.25max.

Unit: mm

● Embossed tape (8mm wide)

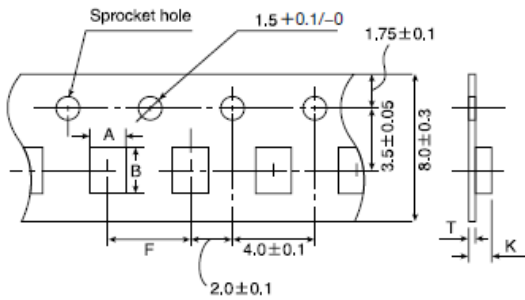

Type(EIA)	Chip Cavity		Insertion Pitch	Tape Thickness	
	A	B		K	T
□WK107(0306) ※	1.0	1.8	4.0±0.1	1.3max.	0.25±0.1
□MK212(0805)	1.65	2.4		3.4max.	0.6max.
□MR212(0805)					
□MK316(1206)	2.0	3.6			
□MR316(1206)					
□MK325(1210)	2.8	3.6			
□MR325(1210)					

Note: ※ LW Reverse type.

Unit: mm

● Embossed tape (12mm wide)

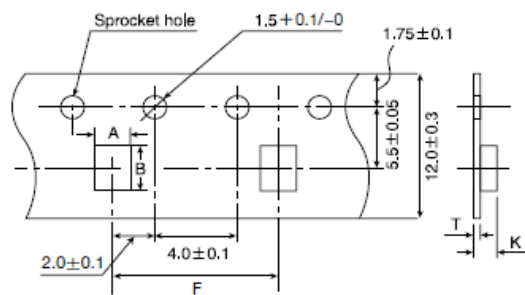

Type(EIA)	Chip Cavity		Insertion Pitch	Tape Thickness	
	A	B		K	T
□MK432(1812)	3.7	4.9	8.0±0.1	4.0max.	0.6max.

Unit: mm

④Trailer and Leader

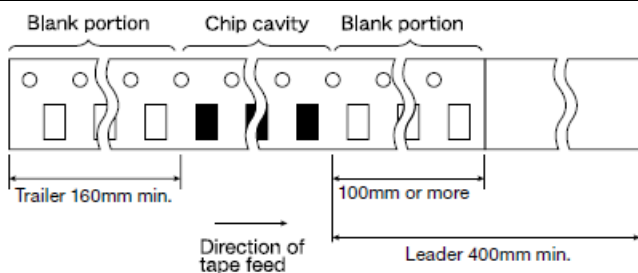

▶ This catalog contains the typical specification only due to the limitation of space. When you consider the purchase of our products, please check our specification. For details of each product (characteristics graph, reliability information, precautions for use, and so on), see our Web site (<http://www.ty-top.com/>).

⑤ Reel size

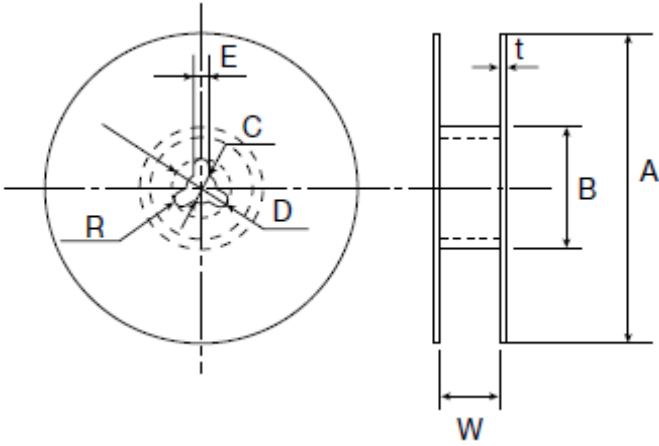

A	B	C	D	E	R
$\phi 178 \pm 2.0$	$\phi 50 \text{min.}$	$\phi 13.0 \pm 0.2$	$\phi 21.0 \pm 0.8$	$2.0 \pm 0.5$	1.0

	T	W
4mm wide tape	1.5max.	$5 \pm 1.0$
8mm wide tape	2.5max.	$10 \pm 1.5$
12mm wide tape	2.5max.	$14 \pm 1.5$

Unit : mm

⑥ Top Tape Strength

The top tape requires a peel-off force of 0.1 to 0.7N in the direction of the arrow as illustrated below.

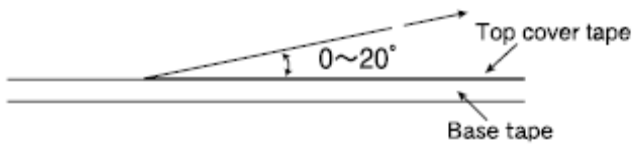

⑦ Bulk Cassette

The exchange of individual specification is necessary.  
Please contact Taiyo Yuden sales channels.

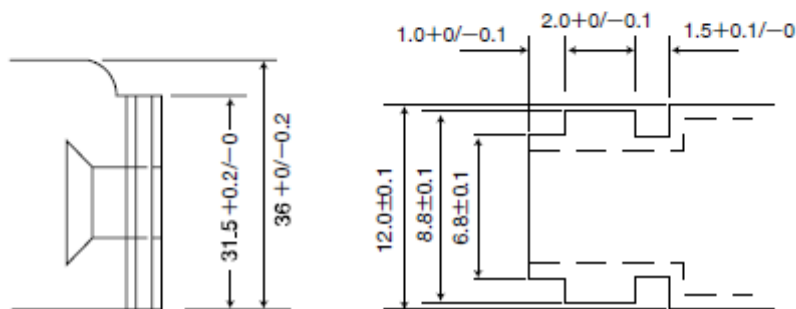
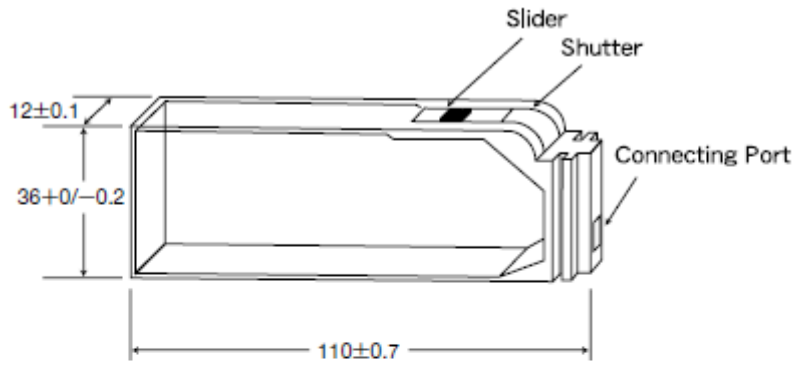

Unit : mm

▶ This catalog contains the typical specification only due to the limitation of space. When you consider the purchase of our products, please check our specification.  
For details of each product (characteristics graph, reliability information, precautions for use, and so on), see our Web site (<http://www.ty-top.com/>).

# Multilayer Ceramic Capacitors

## RELIABILITY DATA

### 1. Operating Temperature Range

Specified Value	Temperature Compensating (Class1)	Standard	-55 to +125°C	
		High Frequency Type		
Specified Value	High Permittivity (Class2)		Specification	Temperature Range
		BJ	B	-25 to +85°C
			X5R	-55 to +85°C
		B7	X7R	-55 to +125°C
		C6	X6S	-55 to +105°C
		C7	X7S	-55 to +125°C
		LD(※)	X5R	-55 to +85°C
		F	F	-25 to +85°C
Y5V	-30 to +85°C			

Note: ※LD Low distortion high value multilayer ceramic capacitor

### 2. Storage Conditions

Specified Value	Temperature Compensating (Class1)	Standard	-55 to +125°C	
		High Frequency Type		
Specified Value	High Permittivity (Class2)		Specification	Temperature Range
		BJ	B	-25 to +85°C
			X5R	-55 to +85°C
		B7	X7R	-55 to +125°C
		C6	X6S	-55 to +105°C
		C7	X7S	-55 to +125°C
		LD(※)	X5R	-55 to +85°C
		F	F	-25 to +85°C
Y5V	-30 to +85°C			

Note: ※LD Low distortion high value multilayer ceramic capacitor

### 3. Rated Voltage

Specified Value	Temperature Compensating (Class1)	Standard	50VDC, 25VDC, 16VDC
		High Frequency Type	50VDC, 16VDC
	High Permittivity (Class2)		50VDC, 35VDC, 25VDC, 16VDC, 10VDC, 6.3VDC, 4VDC, 2.5VDC

### 4. Withstanding Voltage (Between terminals)

Specified Value	Temperature Compensating (Class1)	Standard	No breakdown or damage
		High Frequency Type	
	High Permittivity (Class2)		
Test Methods and Remarks		Class 1	Class 2
	Applied voltage	Rated volta × 3	Rated voltage × 2.5
	Duration	1 to 5 sec.	
	Charge/discharge current	50mA max.	

### 5. Insulation Resistance

Specified Value	Temperature Compensating (Class1)	Standard	10000 MΩ min.
		High Frequency Type	
	High Permittivity (Class2) Note 1		C ≤ 0.047 μF : 10000 MΩ min. C > 0.047 μF : 500MΩ · μF
Test Methods and Remarks	Applied voltage	: Rated voltage	
	Duration	: 60 ± 5 sec.	
	Charge/discharge current	: 50mA max.	

▶ This catalog contains the typical specification only due to the limitation of space. When you consider the purchase of our products, please check our specification. For details of each product (characteristics graph, reliability information, precautions for use, and so on), see our Web site (<http://www.ty-top.com/>).

6. Capacitance (Tolerance)					
Specified Value	Temperature Compensating(Class1)	Standard	C□	0.2pF ≤ C ≤ 5pF : ±0.25pF	
			U□	0.2pF ≤ C ≤ 10pF : ±0.5pF	
	SL	C > 10pF : ±5% or ±10%			
High Permittivity (Class2)	High Frequency Type	CH	0.3pF ≤ C ≤ 2pF : ±0.1pF		
		RH	C > 2pF : ±5%		
High Permittivity (Class2)			BJ, B7, C6, C7, LD(※) : ±10% or ±20%, F : +80/-20% Note: ※LD Low distortion high value multilayer ceramic capacitor		
Test Methods and Remarks			Class 1		
			Standard	High Frequency Type	
	Preconditioning		None		
	Measuring frequency		1MHz ± 10%		
	Measuring voltage Note		0.5 to 5Vrms		
Bias application		one			
				Class 2	
		C ≤ 10 μF		C > 10 μF	
Preconditioning		Thermal treatment (at 150°C for 1hr) Note 2			
Measuring frequency		1kHz ± 10%		120 ± 10Hz	
Measuring voltage Note		1 ± 0.2Vrms		0.5 ± 0.1rms	
Bias application		one			

7. Q or Dissipation Factor					
Specified Value	Temperature Compensating(Class1)	Standard	C < 30pF : Q ≥ 400 + 20C C ≥ 30pF : Q ≥ 1000 (C: Nominal capacitance)		
			High Frequency Type	Refer to detailed specification	
	High Permittivity (Class2) Note 1		BJ, B7, C6, C7: 2.5% max., F: 7% max.		
Test Methods and Remarks			Class 1		
			Standard	High Frequency Type	
	Preconditioning		None		
	Measuring frequency		1MHz ± 10%		1GHz
	Measuring voltage Note 1		0.5 to 5Vrms		
Bias application		None			
				Class 2	
		C ≤ 10 μF		C > 10 μF	
Preconditioning		Thermal treatment (at 150°C for 1hr) Note 2			
Measuring frequency		1kHz ± 10%		120 ± 10Hz	
Measuring voltage Note 1		1 ± 0.2Vrms		0.5 ± 0.1Vrms	
Bias application		None			
High Frequency Type		Measuring equipment : HP4291A			
Measuring equipment		Measuring jig : HP16192A			

8. Temperature Characteristic (Without voltage application)						
Specified Value	Temperature Compensating(Class1)	Standard	Temperature Characteristic [ppm/°C]		Tolerance [ppm/°C]	
			C□ : 0	CH, CJ, CK	H : ±60	
			U□ : -750	UJ, UK	J : ±120	
		SL : +350 to -1000			K : ±250	
High Permittivity (Class2)	High Frequency Type	Temperature Characteristic [ppm/°C]		Tolerance [ppm/°C]		
		C□ : 0	CH	H : ±60		
		R□ : -220	RH			
		Specification	Capacitance change	Reference temperature	Temperature Range	
		BJ	B	±10%	20°C	-25 to +85°C
			X5R	±15%	25°C	-55 to +85°C
		B7	X7R	±15%	25°C	-55 to +125°C
		C6	X6S	±22%	25°C	-55 to +105°C
		C7	X7S	±22%	25°C	-55 to +125°C
		LD(※)	X5R	±15%	25°C	-55 to +85°C
		F	F	+30/-80%	20°C	-25 to +85°C
			Y5V	+22/-82%	25°C	-30 to +85°C
Note : ※LD Low distortion high value multilayer ceramic capacitor						
Test Methods and Remarks	Class 1					
	Capacitance at 20°C and 85°C shall be measured in thermal equilibrium, and the temperature characteristic shall be calculated from the following equation.					
	$\frac{(C_{85} - C_{20})}{C_{20} \times \Delta T} \times 10^6 (\text{ppm}/^\circ\text{C}) \quad \Delta T = 65$					
	Class 2					
	Capacitance at each step shall be measured in thermal equilibrium, and the temperature characteristic shall be calculated from the following equation.					
Step	B, F		X5R, X7R, X6S, X7S, Y5V			
1	Minimum operating temperature					
2	20°C		25°C			
3	Maximum operating temperature					

▶ This catalog contains the typical specification only due to the limitation of space. When you consider the purchase of our products, please check our specification. For details of each product (characteristics graph, reliability information, precautions for use, and so on), see our Web site (<http://www.ty-top.com/>).

	$\frac{(C-C_2)}{C_2} \times 100(\%)$ <p>C : Capacitance in Step 1 or Step 3 C2 : Capacitance in Step 2</p>
--	--

**9. Deflection**

Specified Value	Temperature Compensating (Class1)	Standard	Appearance : No abnormality Capacitance change : Within $\pm 5\%$ or $\pm 0.5$ pF, whichever is larger.
		High Frequency Type	Appearance : No abnormality Capacitance change : Within $\pm 0.5$ pF
	High Permittivity (Class2)		Appearance : No abnormality Capacitance change : Within $\pm 12.5\%$ (BJ, B7, C6, C7, LD(※)) Within $\pm 30\%$ (F) Note: ※LD Low distortion high value multilayer ceramic capacitor

Test Methods and Remarks	<table border="1"> <tr> <th colspan="2">Multilayer Ceramic Capacitors</th> </tr> <tr> <td>042, 063, ※105 Type</td> <td>The other types</td> </tr> <tr> <td>Board</td> <td>Glass epoxy-resin substrate</td> </tr> <tr> <td>Thickness</td> <td>0.8mm / 1.6mm</td> </tr> <tr> <td>Warp</td> <td>1mm</td> </tr> <tr> <td>Duration</td> <td>10 sec.</td> </tr> </table> <p>※105 Type thickness, C: 0.2mm, P: 0.3mm.</p>		Multilayer Ceramic Capacitors		042, 063, ※105 Type	The other types	Board	Glass epoxy-resin substrate	Thickness	0.8mm / 1.6mm	Warp	1mm	Duration	10 sec.	<p>(Unit: mm) Capacitance measurement shall be conducted with the board bent</p>
	Multilayer Ceramic Capacitors														
042, 063, ※105 Type	The other types														
Board	Glass epoxy-resin substrate														
Thickness	0.8mm / 1.6mm														
Warp	1mm														
Duration	10 sec.														

**10. Body Strength**

Specified Value	Temperature Compensating (Class1)	Standard	—
		High Frequency Type	No mechanical damage.
	High Permittivity (Class2)		—
Test Methods and Remarks	High Frequency Type Applied force : 5N Duration : 10 sec.		

**11. Adhesive Strength of Terminal Electrodes**

Specified Value	Temperature Compensating (Class1)	Standard	No terminal separation or its indication.								
		High Frequency Type									
	High Permittivity (Class2)										
Test Methods and Remarks	<table border="1"> <tr> <th colspan="2">Multilayer Ceramic Capacitors</th> </tr> <tr> <td>042, 063 Type</td> <td>105 Type or more</td> </tr> <tr> <td>Applied force</td> <td>2N / 5N</td> </tr> <tr> <td>Duration</td> <td>30 ± 5 sec.</td> </tr> </table>		Multilayer Ceramic Capacitors		042, 063 Type	105 Type or more	Applied force	2N / 5N	Duration	30 ± 5 sec.	
Multilayer Ceramic Capacitors											
042, 063 Type	105 Type or more										
Applied force	2N / 5N										
Duration	30 ± 5 sec.										

**12. Solderability**

Specified Value	Temperature Compensating (Class1)	Standard	At least 95% of terminal electrode is covered by new solder.												
		High Frequency Type													
	High Permittivity (Class2)														
Test Methods and Remarks	<table border="1"> <tr> <th colspan="2">Eutectic solder</th> <th>Lead-free solder</th> </tr> <tr> <td>Solder type</td> <td>H60A or H63A</td> <td>Sn-3.0Ag-0.5Cu</td> </tr> <tr> <td>Solder temperature</td> <td>230 ± 5°C</td> <td>245 ± 3°C</td> </tr> <tr> <td>Duration</td> <td colspan="2">4 ± 1 sec.</td> </tr> </table>		Eutectic solder		Lead-free solder	Solder type	H60A or H63A	Sn-3.0Ag-0.5Cu	Solder temperature	230 ± 5°C	245 ± 3°C	Duration	4 ± 1 sec.		
Eutectic solder		Lead-free solder													
Solder type	H60A or H63A	Sn-3.0Ag-0.5Cu													
Solder temperature	230 ± 5°C	245 ± 3°C													
Duration	4 ± 1 sec.														

▶ This catalog contains the typical specification only due to the limitation of space. When you consider the purchase of our products, please check our specification. For details of each product (characteristics graph, reliability information, precautions for use, and so on), see our Web site (<http://www.ty-top.com/>).

### 13. Resistance to Soldering

Specified Value	Temperature Compensating (Class1)	Standard	Appearance : No abnormality Capacitance change : Within $\pm 2.5\%$ or $\pm 0.25\text{pF}$ , whichever is larger. Q : Initial value Insulation resistance : Initial value Withstanding voltage (between terminals) : No abnormality
		High Frequency Type	Appearance : No abnormality Capacitance change : Within $\pm 2.5\%$ Q : Initial value Insulation resistance : Initial value Withstanding voltage (between terminals) : No abnormality
	High Permittivity (Class2) Note 1		Appearance : No abnormality Capacitance change : Within $\pm 7.5\%$ (BJ, B7, C6, C7, LD(※)) Within $\pm 20\%$ (F) Dissipation factor : Initial value Insulation resistance : Initial value Withstanding voltage (between terminals) : No abnormality Note: ※LD Low distortion high value multilayer ceramic capacitor

Test Methods and Remarks	Class 1			
		042, 063 Type	105 Type	
	Preconditioning	None		
	Preheating	150°C, 1 to 2 min.	80 to 100°C, 2 to 5 min. 150 to 200°C, 2 to 5 min.	
	Solder temp.	270 $\pm$ 5°C		
	Duration	3 $\pm$ 0.5 sec.		
	Recovery	6 to 24 hrs (Standard condition) Note 5		
	Class 2			
		042, 063 Type	105, 107, 212 Type	316, 325 Type
	Preconditioning	Thermal treatment (at 150°C for 1 hr) Note 2		
	Preheating	150°C, 1 to 2 min.	80 to 100°C, 2 to 5 min. 150 to 200°C, 2 to 5 min.	80 to 100°C, 5 to 10 min. 150 to 200°C, 5 to 10 min.
	Solder temp.	270 $\pm$ 5°C		
	Duration	3 $\pm$ 0.5 sec.		
	Recovery	24 $\pm$ 2 hrs (Standard condition) Note 5		

### 14. Temperature Cycle (Thermal Shock)

Specified Value	Temperature Compensating (Class1)	Standard	Appearance : No abnormality Capacitance change : Within $\pm 2.5\%$ or $\pm 0.25\text{pF}$ , whichever is larger. Q : Initial value Insulation resistance : Initial value Withstanding voltage (between terminals) : No abnormality
		High Frequency Type	Appearance : No abnormality Capacitance change : Within $\pm 0.25\text{pF}$ Q : Initial value Insulation resistance : Initial value Withstanding voltage (between terminals) : No abnormality
	High Permittivity (Class2) Note 1		Appearance : No abnormality Capacitance change : Within $\pm 7.5\%$ (BJ, B7, C6, C7, LD(※)) Within $\pm 20\%$ (F) Dissipation factor : Initial value Insulation resistance : Initial value Withstanding voltage (between terminals) : No abnormality Note: ※LD Low distortion high value multilayer ceramic capacitor

Test Methods and Remarks	Class 1		Class 2		
	Preconditioning	None		Thermal treatment (at 150°C for 1 hr) Note 2	
	1 cycle	Step	Temperature (°C)	Time (min.)	
		1	Minimum operating temperature	30 $\pm$ 3	
		2	Normal temperature	2 to 3	
		3	Maximum operating temperature	30 $\pm$ 3	
4	Normal temperature	2 to 3			
Number of cycles	5 times				
Recovery	6 to 24 hrs (Standard condition) Note 5		24 $\pm$ 2 hrs (Standard condition) Note 5		

▶ This catalog contains the typical specification only due to the limitation of space. When you consider the purchase of our products, please check our specification.  
For details of each product (characteristics graph, reliability information, precautions for use, and so on), see our Web site (<http://www.ty-top.com/>).

15. Humidity (Steady State)

Specified Value	Temperature Compensating (Class1)	Standard	Appearance : No abnormality Capacitance change : Within $\pm 5\%$ or $\pm 0.5\text{pF}$ , whichever is larger. Q : $C < 10\text{pF} : Q \geq 200 + 10C$ $10 \leq C < 30\text{pF} : Q \geq 275 + 2.5C$ $C \geq 30\text{pF} : Q \geq 350 (C : \text{Nominal capacitance})$ Insulation resistance : $1000 \text{ M}\Omega$ min.
		High Frequency Type	Appearance : No abnormality Capacitance change : Within $\pm 0.5\text{pF}$ , Insulation resistance : $1000 \text{ M}\Omega$ min.
	High Permittivity (Class2) Note 1		Appearance : No abnormality Capacitance change : Within $\pm 12.5\%$ (BJ, B7, C6, C7, LD(※)) Within $\pm 30\%$ (F) Dissipation factor : $5.0\%$ max. (BJ, B7, C6, C7, LD(※)) $11.0\%$ max. (F) Insulation resistance : $50 \text{ M}\Omega \mu\text{F}$ or $1000 \text{ M}\Omega$ whichever is smaller. Note: ※LD Low distortion high value multilayer ceramic capacitor

Test Methods and Remarks		Class 1		Class 2
		Standard	High Frequency Type	All items
	Preconditioning	None		
	Temperature	$40 \pm 2^\circ\text{C}$	$60 \pm 2^\circ\text{C}$	$40 \pm 2^\circ\text{C}$
	Humidity	90 to 95%RH		90 to 95%RH
	Duration	$500 + 24 / - 0$ hrs		$500 + 24 / - 0$ hrs
	Recovery	6 to 24 hrs (Standard condition) Note 5		$24 \pm 2$ hrs (Standard condition) Note 5

16. Humidity Loading

Specified Value	Temperature Compensating (Class1)	Standard	Appearance : No abnormality Capacitance change : Within $\pm 7.5\%$ or $\pm 0.75\text{pF}$ , whichever is larger. Q : $C < 30\text{pF} : Q \geq 100 + 10C/3$ $C \geq 30\text{pF} : Q \geq 200 (C : \text{Nominal capacitance})$ Insulation resistance : $500 \text{ M}\Omega$ min.
		High Frequency Type	Appearance : No abnormality Capacitance change : $C \leq 2\text{pF} : \text{Within } \pm 0.4 \text{ pF}$ $C > 2\text{pF} : \text{Within } \pm 0.75 \text{ pF}$ (C:Nominal capacitance) Insulation resistance : $500 \text{ M}\Omega$ min.
	High Permittivity (Class2) Note 1		Appearance : No abnormality Capacitance change : Within $\pm 12.5\%$ (BJ, B7, C6, C7, LD(※)) Within $\pm 30\%$ (F) Dissipation factor : $5.0\%$ max. (BJ, B7, C6, C7, LD(※)) $11.0\%$ max. (F) Insulation resistance : $25 \text{ M}\Omega \mu\text{F}$ or $500 \text{ M}\Omega$ , whichever is smaller. Note: ※LD Low distortion high value multilayer ceramic capacitor

Test Methods and Remarks		Class 1		Class 2
		Standard	High Frequency Type	All items
	Preconditioning	None		
	Temperature	$40 \pm 2^\circ\text{C}$	$60 \pm 2^\circ\text{C}$	$40 \pm 2^\circ\text{C}$
	Humidity	90 to 95%RH		90 to 95%RH
	Duration	$500 + 24 / - 0$ hrs		$500 + 24 / - 0$ hrs
	Applied voltage	Rated voltage		Rated voltage
	Charge/discharge current	50mA max.		50mA max.
Recovery	6 to 24 hrs (Standard condition) Note 5		$24 \pm 2$ hrs (Standard condition) Note 5	

► This catalog contains the typical specification only due to the limitation of space. When you consider the purchase of our products, please check our specification. For details of each product (characteristics graph, reliability information, precautions for use, and so on), see our Web site (<http://www.ty-top.com/>).

17. High Temperature Loading

Specified Value	Temperature Compensating (Class1)	Standard	Appearance : No abnormality Capacitance change : Within $\pm 3\%$ or $\pm 0.3\text{pF}$ , whichever is larger. Q : $C < 10\text{pF}$ : $Q \geq 200 + 10C$ $10 \leq C < 30\text{pF}$ : $Q \geq 275 + 2.5C$ $C \geq 30\text{pF}$ : $Q \geq 350$ (C: Nominal capacitance) Insulation resistance : $1000 \text{ M}\Omega$ min.
		High Frequency Type	Appearance : No abnormality Capacitance change : Within $\pm 3\%$ or $\pm 0.3\text{pF}$ , whichever is larger. Insulation resistance : $1000 \text{ M}\Omega$ min.
	High Permittivity (Class2) Note 1		Appearance : No abnormality Capacitance change : Within $\pm 12.5\%$ (BJ, B7, C6, C7, LD(※)) Within $\pm 30\%$ (F) Dissipation factor : $5.0\%$ max. (BJ, B7, C6, C7, LD(※)) $11.0\%$ max. (F) Insulation resistance : $50 \text{ M}\Omega \mu\text{F}$ or $1000 \text{ M}\Omega$ , whichever is smaller. Note: ※LD Low distortion high value multilayer ceramic capacitor

Test Methods and Remarks		Class 1		Class 2		
		Standard	High Frequency Type	BJ, LD(※), F	C6	B7, C7
	Preconditioning	None		Voltage treatment (Twice the rated voltage shall be applied for 1 hour at $85^\circ\text{C}$ , $105^\circ\text{C}$ or $125^\circ\text{C}$ ) Note 3, 4		
	Temperature	Maximum operating temperature		Maximum operating temperature		
	Duration	$1000 + 48 / - 0$ hrs		$1000 + 48 / - 0$ hrs		
	Applied voltage	Rated voltage $\times 2$		Rated voltage $\times 2$ Note 4		
	Charge/discharge current	50mA max.		50mA max.		
	Recovery	6 to 24hr (Standard condition) Note 5		$24 \pm 2$ hrs (Standard condition) Note 5		

Note: ※LD Low distortion high value multilayer ceramic capacitor

Note 1 The figures indicate typical specifications. Please refer to individual specifications in detail.

Note 2 Thermal treatment : Initial value shall be measured after test sample is heat-treated at  $150 \pm 0 / - 10^\circ\text{C}$  for an hour and kept at room temperature for  $24 \pm 2$  hours.

Note 3 Voltage treatment : Initial value shall be measured after test sample is voltage-treated for an hour at both the temperature and voltage specified in the test conditions, and kept at room temperature for  $24 \pm 2$  hours.

Note 4 150% of rated voltage is applicable to some items. Please refer to their specifications for further information.

Note 5 Standard condition: Temperature: 5 to  $35^\circ\text{C}$ , Relative humidity: 45 to 85 % RH, Air pressure: 86 to 106kPa When there are questions concerning measurement results, in order to provide correlation data, the test shall be conducted under the following condition.

Temperature:  $20 \pm 2^\circ\text{C}$ , Relative humidity: 60 to 70 % RH, Air pressure: 86 to 106kPa Unless otherwise specified, all the tests are conducted under the "standard condition".



# Precautions on the use of Multilayer Ceramic Capacitors

## PRECAUTIONS

### 1. Circuit Design

- Precautions**
- ◆ Verification of operating environment, electrical rating and performance
    1. A malfunction of equipment in fields such as medical, aerospace, nuclear control, etc. may cause serious harm to human life or have severe social ramifications. Therefore, any capacitors to be used in such equipment may require higher safety and reliability, and shall be clearly differentiated from them used in general purpose applications.
  - ◆ Operating Voltage (Verification of Rated voltage)
    1. The operating voltage for capacitors must always be their rated voltage or less. If an AC voltage is loaded on a DC voltage, the sum of the two peak voltages shall be the rated voltage or less. For a circuit where an AC or a pulse voltage may be used, the sum of their peak voltages shall also be the rated voltage or less.
    2. Even if an applied voltage is the rated voltage or less reliability of capacitors may be deteriorated in case that either a high frequency AC voltage or a pulse voltage having rapid rise time is used in a circuit.

### 2. PCB Design

- Precautions**
- ◆ Pattern configurations (Design of Land-patterns)
    1. When capacitors are mounted on PCBs, the amount of solder used (size of fillet) can directly affect the capacitor performance. Therefore, the following items must be carefully considered in the design of land patterns:
      - (1) Excessive solder applied can cause mechanical stresses which lead to chip breaking or cracking. Therefore, please consider appropriate land-patterns for proper amount of solder.
      - (2) When more than one component are jointly soldered onto the same land, each component's soldering point shall be separated by solder-resist.
  - ◆ Pattern configurations (Capacitor layout on PCBs)
 

After capacitors are mounted on boards, they can be subjected to mechanical stresses in subsequent manufacturing processes (PCB cutting, board inspection, mounting of additional parts, assembly into the chassis, wave soldering of the boards, etc.). For this reason, land pattern configurations and positions of capacitors shall be carefully considered to minimize stresses.

◆ Pattern configurations (Design of Land-patterns)  
The following diagrams and tables show some examples of recommended land patterns to prevent excessive solder amounts.

(1) Recommended land dimensions for typical chip capacitors

● Multilayer Ceramic Capacitors : Recommended land dimensions (unit: mm)

		Wave-soldering			
Type		107	212	316	325
Size	L	1.6	2.0	3.2	3.2
	W	0.8	1.25	1.6	2.5
A		0.8 to 1.0	1.0 to 1.4	1.8 to 2.5	1.8 to 2.5
B		0.5 to 0.8	0.8 to 1.5	0.8 to 1.7	0.8 to 1.7
C		0.6 to 0.8	0.9 to 1.2	1.2 to 1.6	1.8 to 2.5

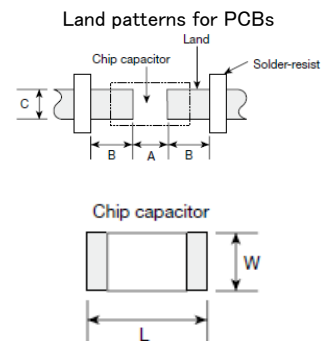

Reflow-soldering

Type		042	063	105	107	212	316	325	432
Size	L	0.4	0.6	1.0	1.6	2.0	3.2	3.2	4.5
	W	0.2	0.3	0.5	0.8	1.25	1.6	2.5	3.2
A		0.15 to 0.25	0.20 to 0.30	0.45 to 0.55	0.8 to 1.0	0.8 to 1.2	1.8 to 2.5	1.8 to 2.5	2.5 to 3.5
B		0.15 to 0.20	0.20 to 0.30	0.40 to 0.50	0.6 to 0.8	0.8 to 1.2	1.0 to 1.5	1.0 to 1.5	1.5 to 1.8
C		0.15 to 0.30	0.25 to 0.40	0.45 to 0.55	0.6 to 0.8	0.9 to 1.6	1.2 to 2.0	1.8 to 3.2	2.3 to 3.5

Note: Recommended land size might be different according to the allowance of the size of the product.

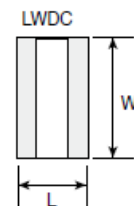

● LWDC: Recommended land dimensions for reflow-soldering (unit: mm)

Type		105	107	212
Size	L	0.52	0.8	1.25
	W	1.0	1.6	2.0
A		0.18 to 0.22	0.25 to 0.3	0.5 to 0.7
B		0.2 to 0.25	0.3 to 0.4	0.4 to 0.5
C		0.9 to 1.1	1.5 to 1.7	1.9 to 2.1



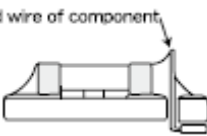
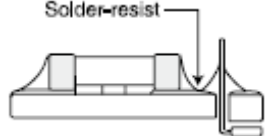

Technical considerations

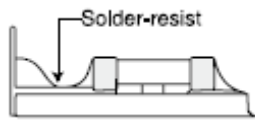
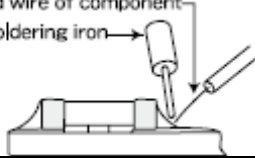
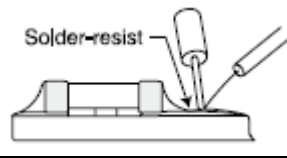
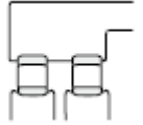
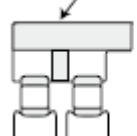
(2) Examples of good and bad solder application

Items	Not recommended	Recommended
Mixed mounting of SMD and leaded components		
Component placement close to the chassis		
Hand-soldering of leaded components near mounted components		
Horizontal component placement		

◆ Pattern configurations (Capacitor layout on PCBs)

1-1. The following is examples of good and bad capacitor layouts ; capacitors shall be located to minimize any possible mechanical stresses from board warp or deflection.

Items	Not recommended	Recommended
Deflection of board		

Place the product at a right angle to the direction of the anticipated mechanical stress.

1-2. The amount of mechanical stresses given will vary depending on capacitor layout. Please refer to diagram below.

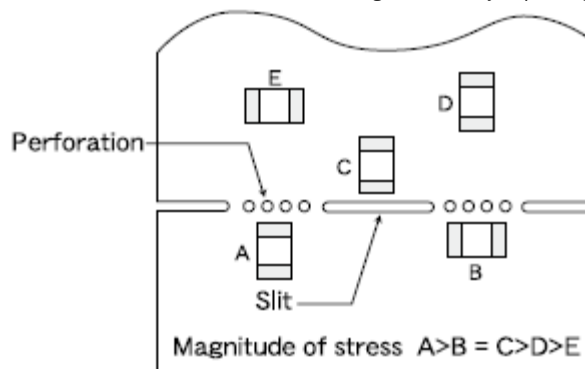

1-3. When PCB is split, the amount of mechanical stress on the capacitors can vary according to the method used. The following methods are listed in order from least stressful to most stressful: push-back, slit, V-grooving, and perforation. Thus, please consider the PCB, split methods as well as chip location.

3. Mounting

Precautions

◆ Adjustment of mounting machine

- When capacitors are mounted on PCB, excessive impact load shall not be imposed on them.
- Maintenance and inspection of mounting machines shall be conducted periodically.

◆ Selection of Adhesives

- When chips are attached on PCBs with adhesives prior to soldering, it may cause capacitor characteristics degradation unless the following factors are appropriately checked : size of land patterns, type of adhesive, amount applied, hardening temperature and hardening period. Therefore, please contact us for further information.

Technical considerations

◆ Adjustment of mounting machine

- When the bottom dead center of a pick-up nozzle is too low, excessive force is imposed on capacitors and causes damages. To avoid this, the following points shall be considerable.
  - The bottom dead center of the pick-up nozzle shall be adjusted to the surface level of PCB without the board deflection.
  - The pressure of nozzle shall be adjusted between 1 and 3 N static loads.
  - To reduce the amount of deflection of the board caused by impact of the pick-up nozzle, supporting pins or back-up pins shall be used on the other side of the PCB. The following diagrams show some typical examples of good and bad pick-up nozzle placement:

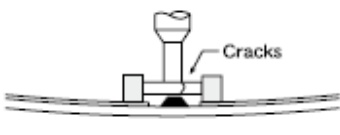
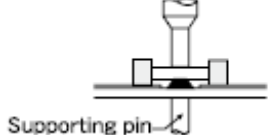
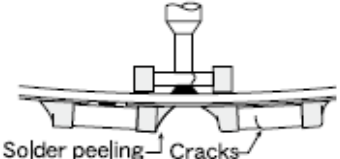
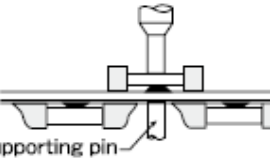
Items	Not recommended	Recommended
Single-sided mounting		
Double-sided mounting		

2. As the alignment pin is worn out, adjustment of the nozzle height can cause chipping or cracking of capacitors because of mechanical impact on the capacitors.  
To avoid this, the monitoring of the width between the alignment pins in the stopped position, maintenance, check and replacement of the pin shall be conducted periodically.

◆ Selection of Adhesives

Some adhesives may cause IR deterioration. The different shrinkage percentage of between the adhesive and the capacitors may result in stresses on the capacitors and lead to cracking. Moreover, too little or too much adhesive applied to the board may adversely affect components. Therefore, the following precautions shall be noted in the application of adhesives.

(1) Required adhesive characteristics

- The adhesive shall be strong enough to hold parts on the board during the mounting & solder process.
- The adhesive shall have sufficient strength at high temperatures.
- The adhesive shall have good coating and thickness consistency.
- The adhesive shall be used during its prescribed shelf life.
- The adhesive shall harden rapidly.
- The adhesive shall have corrosion resistance.
- The adhesive shall have excellent insulation characteristics.
- The adhesive shall have no emission of toxic gasses and no effect on the human body.

(2) The recommended amount of adhesives is as follows;

[Recommended condition]

Figure	212/316 case sizes as examples
a	0.3mm min
b	100 to 120 $\mu$ m
c	Adhesives shall not contact land

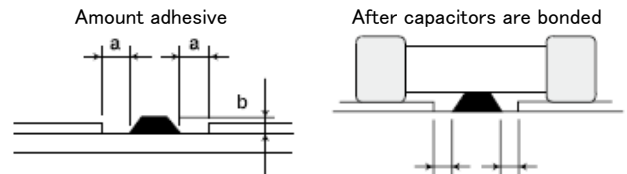

4. Soldering

◆ Selection of Flux

Since flux may have a significant effect on the performance of capacitors, it is necessary to verify the following conditions prior to use;

- Flux used shall be less than or equal to 0.1 wt% ( in Cl equivalent) of halogenated content. Flux having a strong acidity content shall not be applied.
- When shall capacitors are soldered on boards, the amount of flux applied shall be controlled at the optimum level.
- When water-soluble flux is used, special care shall be taken to properly clean the boards.

Precautions

◆ Soldering

Temperature, time, amount of solder, etc. shall be set in accordance with their recommended conditions.

Sn-Zn solder paste can adversely affect MLCC reliability.

Please contact us prior to usage of Sn-Zn solder.

◆ Selection of Flux

1-1. When too much halogenated substance (Chlorine, etc.) content is used to activate flux, or highly acidic flux is used, it may lead to corrosion of terminal electrodes or degradation of insulation resistance on the surfaces of the capacitors.

1-2. Flux is used to increase solderability in wave soldering. However if too much flux is applied, a large amount of flux gas may be emitted and may adversely affect the solderability. To minimize the amount of flux applied, it is recommended to use a flux-bubbling system.

1-3. Since the residue of water-soluble flux is easily dissolved in moisture in the air, the residues on the surfaces of capacitors in high humidity conditions may cause a degradation of insulation resistance and reliability of the capacitors. Therefore, the cleaning methods and the capability of the machines used shall also be considered carefully when water-soluble flux is used.

Technical considerations

◆ Soldering

- Ceramic chip capacitors are susceptible to thermal shock when exposed to rapid or concentrated heating or rapid cooling.
- Therefore, the soldering must be conducted with great care so as to prevent malfunction of the components due to excessive thermal shock.
- Preheating : Capacitors shall be preheated sufficiently, and the temperature difference between the capacitors and solder shall be within 100 to 130°C.
- Cooling : The temperature difference between the capacitors and cleaning process shall not be greater than 100°C.

\* This catalog contains the typical specification only due to the limitation of space. When you consider the purchase of our products, please check our specification.  
For details of each product (characteristics graph, reliability information, precautions for use, and so on), see our Web site (<http://www.ty-top.com/>).

[Reflow soldering]

【Recommended conditions for eutectic soldering】

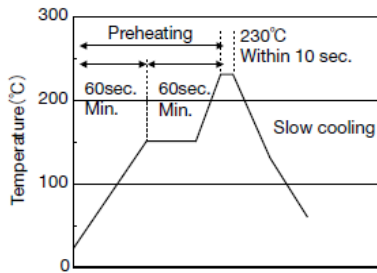

【Recommended condition for Pb-free soldering】

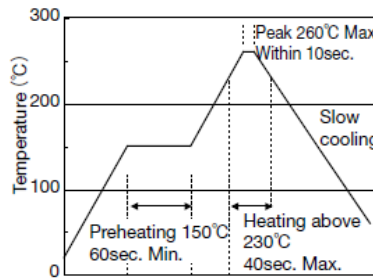

Caution

- ① The ideal condition is to have solder mass (fillet) controlled to  $1/2$  to  $1/3$  of the thickness of a capacitor.
- ② Because excessive dwell times can adversely affect solderability, soldering duration shall be kept as close to recommended times as possible.

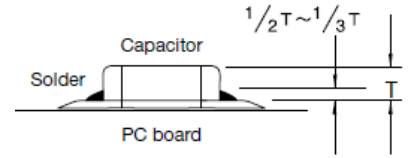

[Wave soldering]

【Recommended conditions for eutectic soldering】

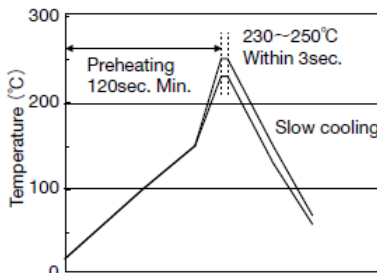

【Recommended condition for Pb-free soldering】

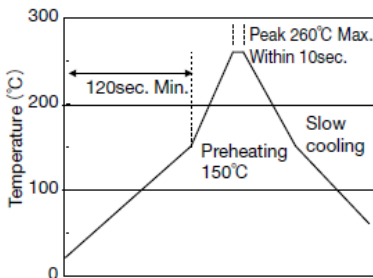

Caution

- ① Wave soldering must not be applied to capacitors designated as for reflow soldering only.

[Hand soldering]

【Recommended conditions for eutectic soldering】

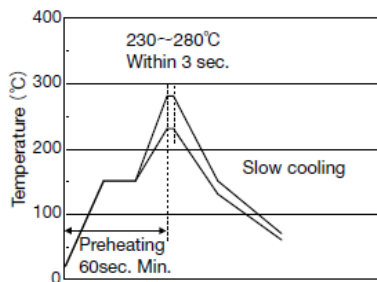

【Recommended condition for Pb-free soldering】

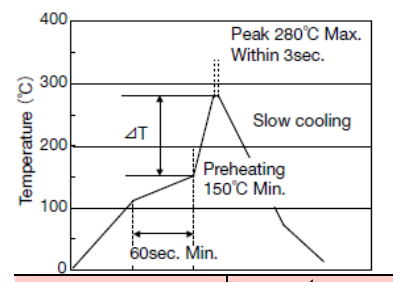
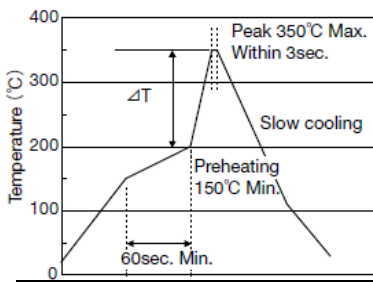

Caution

- ① Use a 50W soldering iron with a maximum tip diameter of 1.0 mm.
- ② The soldering iron shall not directly touch capacitors.

5. Cleaning

◆ Cleaning conditions

Precautions

1. When PCBs are cleaned after capacitors mounting, please select the appropriate cleaning solution in accordance with the intended use of the cleaning. (e.g. to remove soldering flux or other materials from the production process.)
2. Cleaning condition shall be determined after it is verified by using actual cleaning machine that the cleaning process does not affect capacitor's characteristics.

Technical considerations

1. The use of inappropriate cleaning solutions can cause foreign substances such as flux residue to adhere to capacitors or deteriorate their outer coating, resulting in a degradation of the capacitor's electrical properties (especially insulation resistance).
2. Inappropriate cleaning conditions (insufficient or excessive cleaning) may adversely affect the performance of the capacitors. In the case of ultrasonic cleaning, too much power output can cause excessive vibration of PCBs which may lead to the cracking of capacitors or the soldered portion, or decrease the terminal electrodes' strength. Therefore, the following conditions shall be carefully checked:  
 Ultrasonic output : 20 W/l or less  
 Ultrasonic frequency : 40 kHz or less  
 Ultrasonic washing period : 5 min. or less

▶ This catalog contains the typical specification only due to the limitation of space. When you consider the purchase of our products, please check our specification. For details of each product (characteristics graph, reliability information, precautions for use, and so on), see our Web site (<http://www.ty-top.com/>).

6. Resin coating and mold	
Precautions	<p>1. With some type of resins, decomposition gas or chemical reaction vapor may remain inside the resin during the hardening period or while left under normal storage conditions resulting in the deterioration of the capacitor's performance.</p> <p>2. When a resin's hardening temperature is higher than capacitor's operating temperature, the stresses generated by the excessive heat may lead to damage or destruction of capacitors. The use of such resins, molding materials etc. is not recommended.</p>
7. Handling	
Precautions	<p>◆Splitting of PCB</p> <p>1. When PCBs are split after components mounting, care shall be taken so as not to give any stresses of deflection or twisting to the board.</p> <p>2. Board separation shall not be done manually, but by using the appropriate devices.</p> <p>◆Mechanical considerations</p> <p>Be careful not to subject capacitors to excessive mechanical shocks.</p> <p>(1) If ceramic capacitors are dropped onto a floor or a hard surface, they shall not be used.</p> <p>(2) Please be careful that the mounted components do not come in contact with or bump against other boards or components.</p>
8. Storage conditions	
Precautions	<p>◆Storage</p> <p>1. To maintain the solderability of terminal electrodes and to keep packaging materials in good condition, care must be taken to control temperature and humidity in the storage area. Humidity should especially be kept as low as possible.</p> <p>•Recommended conditions</p> <p>Ambient temperature : Below 30°C</p> <p>Humidity : Below 70% RH</p> <p>The ambient temperature must be kept below 40°C. Even under ideal storage conditions, solderability of capacitor is deteriorated as time passes, so capacitors shall be used within 6 months from the time of delivery.</p> <p>•Ceramic chip capacitors shall be kept where no chlorine or sulfur exists in the air.</p> <p>2. The capacitance values of high dielectric constant capacitors will gradually decrease with the passage of time, so care shall be taken to design circuits. Even if capacitance value decreases as time passes, it will get back to the initial value by a heat treatment at 150°C for 1hour.</p>
Technical considerations	<p>If capacitors are stored in a high temperature and humidity environment, it might rapidly cause poor solderability due to terminal oxidation and quality loss of taping/packaging materials. For this reason, capacitors shall be used within 6 months from the time of delivery. If exceeding the above period, please check solderability before using the capacitors.</p>
<p>※RCR-2335B (Safety Application Guide for fixed ceramic capacitors for use in electronic equipment) is published by JEITA. Please check the guide regarding precautions for deflection test, soldering by spot heat, and so on.</p>	